

- Plug-in timer relay
- 2, 3 or 4 CO contact available
- Seven time scales, from 0.05s to 100h
- Multifunctions
- Sockets: see 94 series

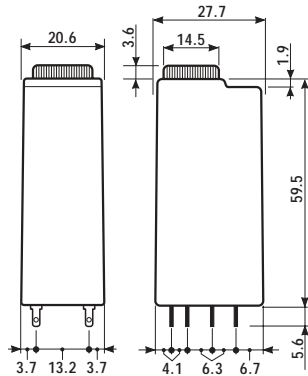

## 85.02

## 85.03

## 85.04



- 2 Pole, 10A
- AC/DC supply non polarized
- Plug-in for use with 94 series sockets

- 3 Pole, 10A
- AC/DC supply non polarized
- Plug-in for use with 94 series sockets

- 4 Pole, 7A
- AC/DC supply non polarized
- Plug-in for use with 94 series sockets

- AI:** ON delay
- DI:** ON pulse
- SW:** Symmetrical recycler: ON start
- GI:** Fixed pulse (0.5s) delayed

- AI:** ON delay
- DI:** ON pulse
- SW:** Symmetrical recycler: ON start
- GI:** Fixed pulse (0.5s) delayed

- AI:** ON delay
- DI:** ON pulse
- SW:** Symmetrical recycler: ON start
- GI:** Fixed pulse (0.5s) delayed

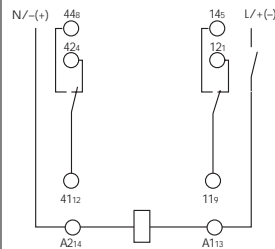

wiring diagram

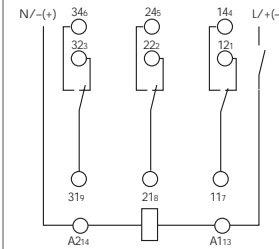

wiring diagram

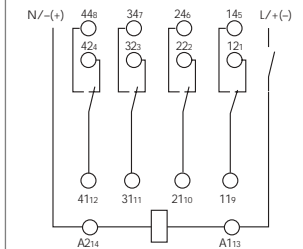

wiring diagram

Contact specifications				
Contact configuration		2 CO	3 CO	4 CO
Rated current/Maximum peak current	A	10/20	10/20	7/15
Rated voltage/Maximum switching voltage V AC		250/400	250/400	250/250
Rated load in AC1	VA	2,500	2,500	1,750
Rated load in AC15 (230 VAC)	VA	500	500	350
Single phase motor rating (230 VAC)	kW	0.37	0.37	0.125
Breaking capacity in DC1:	30/110/220V A	10/0.25/0.1	10/0.25/0.1	7/0.25/0.1
Minimum switching load	mW(V/mA)	300 (5/5)	300 (5/5)	300 (5/5)
Standard contact material		AgNi	AgNi	AgNi
Supply specifications				
Nominal voltage	V AC(50/60Hz)	230...240	230...240	230...240
	V AC/DC	12 - 24 - 48 - 110...125 (non polarized)		
Rated power AC/DC	VA (50Hz)/W	2/2	2/2	2/2
Operating range	AC	(0.85...1.1)U <sub>N</sub>	(0.85...1.1)U <sub>N</sub>	(0.85...1.1)U <sub>N</sub>
	DC	(0.85...1.1)U <sub>N</sub>	(0.85...1.1)U <sub>N</sub>	(0.85...1.1)U <sub>N</sub>
Technical data				
Specified time range		(0.05...1) s, (0.5...10) s, (5...100) s, (0.5...10) min, (5...100) min, (0.5...10) h, (5...100) h		
Repeatability	%	± 2	± 2	± 2
Recovery time	ms	≤ 20	≤ 20	≤ 20
Minimum control impulse	ms	—	—	—
Setting accuracy-full range	%	± 5	± 5	± 5
Electrical life at rated load in AC1	cycles	200 · 10 <sup>3</sup>	200 · 10 <sup>3</sup>	200 · 10 <sup>3</sup>
Ambient temperature range	°C	-20...+60	-20...+60	-20...+60
Protection category		IP 40	IP 40	IP 40
<b>Approvals:</b> (according to type)		CE	SP	GOST
				UL <sup>®</sup> US

## ORDERING INFORMATION

Example: 85 series timer, 4 CO, 24 V AC/DC supply voltage with AI - DI functions.

**8 5 . 0 4 . 0 . 0 2 4 . 0 0 0 0**

**Series**

**Type**

0 = Multifunction (AI, DI, GI, SW)

**No. of poles**

2 = 2 pole - 10 A

3 = 3 pole - 10 A

4 = 4 pole - 7 A

**Supply voltage**

012 = 12 V AC/DC

024 = 24 V AC/DC

048 = 48 V AC/DC

125 = 110...125 V AC/DC

240 = 230...240 V AC

**Supply version**

0 = AC (50/60 Hz)/DC

8 = AC (50/60 Hz) for 240 V only

## TECHNICAL DATA

### EMC SPECIFICATIONS

TYPE OF TEST	REFERENCE STANDARD	
ELECTROSTATIC DISCHARGE	- contact discharge	EN 61000-4-2
	- air discharge	EN 61000-4-2
RADIO-FREQUENCY ELECTROMAGNETIC FIELD (80 ÷ 1000 MHz)	EN 61000-4-3	15 V/m
FAST TRANSIENTS (burst) (5-50 ns, 5 kHz) on Supply terminals	EN 61000-4-4	4 kV
SURGES (1.2/50 µs) on Supply terminals	- common mode	EN 61000-4-5
	- differential mode	EN 61000-4-5
RADIO-FREQUENCY COMMON MODE (0.15 ÷ 80 MHz) on Supply terminals	EN 61000-4-6	10 V
POWER-FREQUENCY (50 Hz)	EN 61000-4-8	30 A/m
RADIATED AND CONDUCTED EMISSION	EN 55022	class B

### OTHER DATA

POWER LOST TO THE ENVIRONMENT	2 pole	3 pole	4 pole
- without contact current	W 1.6	1.6	1.6
- with rated current	W 3.7	4.7	3.6

85

## TIME SCALES

(0.05...1) s	(0.5...10) s	(5...100) s	(0.5...10) min	(5...100) min	(0.5...10) h	(5...100) h

NOTE: time scales and functions must be set before energising the timer.

## FUNCTIONS

	LED	Supply voltage	NO output contact	Contacts	
				Open	Closed
<b>U</b> = Supply voltage		OFF	Open	x1 - x4	x1 - x2
= Output contact		ON	Open	x1 - x4	x1 - x2
		ON	Open (Timing in Progress)	x1 - x4	x1 - x2
		ON	Closed	x1 - x2	x1 - x4

### Wiring diagram

Types: 85.02, 85.03, 85.04

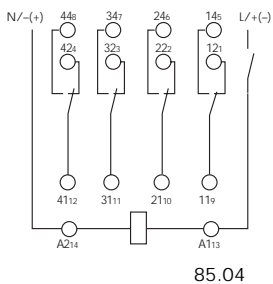
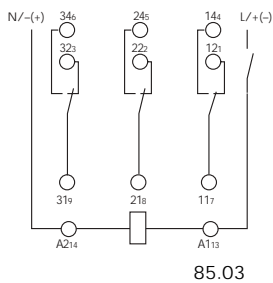
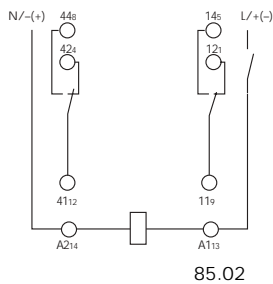

**(AI) ON delay.**  
Apply power to timer. Output contacts transfer after preset time has elapsed. Reset occurs when power is removed.

**(DI) ON pulse.**  
Apply power to timer. Output contacts transfer immediately. After the preset time has elapsed, contacts reset.

**(GI) Fixed pulse (0.5s) delayed.**  
Apply power to timer. Output contacts transfer after preset time has elapsed. Reset occurs after a fixed time of 0.5s. 0.5s.

**(SW) Symmetrical recycler: ON start.**  
Apply power to timer. Output contacts transfer immediately and cycle between ON and OFF for as long as power is applied. The ratio is 1:1 (time on = time off).



94.04

Approvals  
(according to type):



- RATED VALUES: 10 A - 250 V
- DIELECTRIC STRENGTH:  $\geq 2$  kV AC
- PROTECTION CATEGORY: IP 20
- AMBIENT TEMPERATURE: (-40...+70)°C
- TORQUE: 0.5 Nm
- WIRE STRIP LENGTH: 8 mm
- MAX WIRE SIZE:

	solid wire	stranded wire
mm <sup>2</sup>	1x6 / 2x2.5	1x4 / 2x2.5
AWG	1x10 / 2x14	1x12 / 2x14

Timer type	85.02		85.03		85.04	
	BLUE	BLACK	BLUE	BLACK	BLUE	BLACK
Colour	BLUE	BLACK	BLUE	BLACK	BLUE	BLACK
Clamp terminal socket: panel or 35 mm rail (EN 50022) mount	94.02	94.02.0	94.03	94.03.0	94.04	94.04.0
Retaining clip (supplied with timer)	094.81					
6-way jumper link for 94.02, 94.03 and 94.04 sockets	094.06	094.06.0	094.06	094.06.0	094.06	094.06.0
Identification tag	094.00.4					

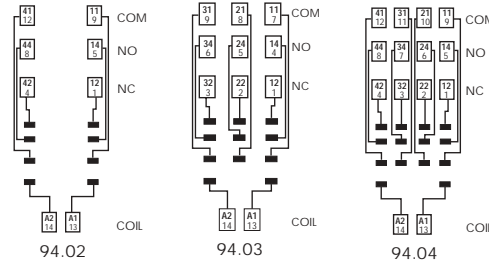
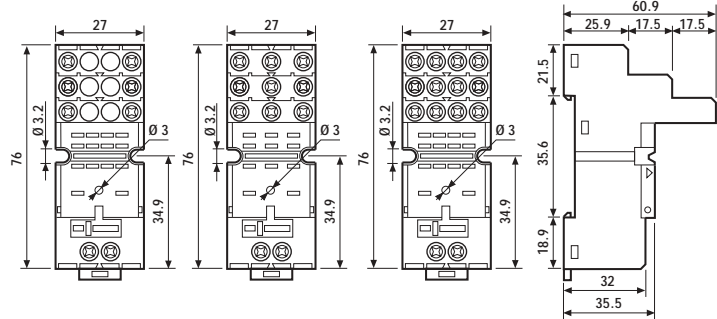

### FOR 94.02, 94.03 AND 94.04 SOCKETS:

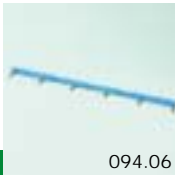

094.06

<b>6-way jumper link</b> for 94.02, 94.03 and 94.04 sockets	094.06
---	--------

- RATED VALUES: 10 A - 250 V

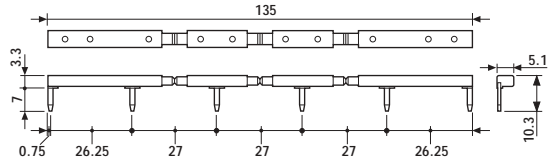



94.74

Approvals  
(according to type):



- RADET VALUES: 10 A - 250 V
- DIELECTRIC STRENGTH:  $\geq 2$  kV AC
- PROTECTION CATEGORY: IP 20
- AMBIENT TEMPERATURE:  
(-40...+70)°C
- TORQUE: 0.5 Nm
- WIRE STRIP LENGTH: 8 mm
- MAX WIRE SIZE:

	solid wire	stranded wire
mm <sup>2</sup>	1x2.5 / 2x1.5	1x2.5 / 2x1.5
AWG	1x14 / 2x16	1x14 / 2x16

Timer type	85.02		85.03		85.04	
	BLUE	BLACK	BLUE	BLACK	BLUE	BLACK
Colour	BLUE	BLACK	BLUE	BLACK	BLUE	BLACK
Screw terminal socket: panel or 35 mm rail (EN 50022) mount	94.72	94.72.0	94.73	94.73.0	94.74	94.74.0
Retaining clip (supplied with timer)	094.81					

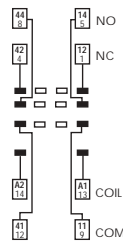
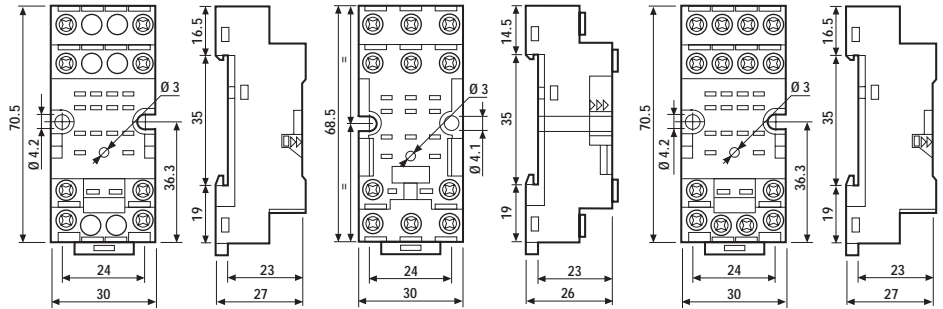

94.72

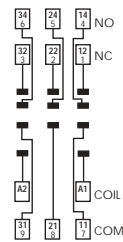

94.73

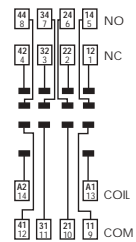

94.74



94.82

Approvals  
(according to type):



- RATED VALUES: 10 A - 250 V
- DIELECTRIC STRENGTH:  $\geq 2$  kV AC
- PROTECTION CATEGORY: IP 20
- AMBIENT TEMPERATURE: (-40...+70)°C
- TORQUE: 0.5 Nm
- WIRE STRIP LENGTH: 9 mm
- MAX WIRE SIZE:

	solid wire	stranded wire
mm <sup>2</sup>	1x2.5 / 2x1.5	1x2.5 / 2x1.5
AWG	1x14 / 2x16	1x14 / 2x16

Timer type	85.02	
	BLUE	BLACK
Colour	BLUE	BLACK
Screw terminal socket: panel or 35 mm rail (EN 50022) mount	94.82	94.82.0
Retaining clip (supplied with timer)	094.81	

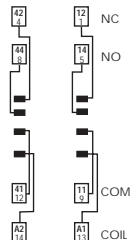
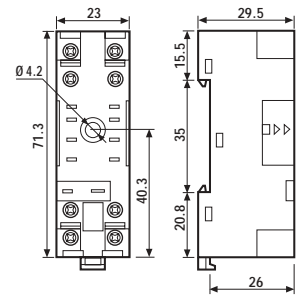

94.82