

Mounting Pads

22590.0452



Product Description

Mounting pads can be used as foot or thrust pad. Not parallel bearing surfaces up to 15° degrees can be compensated.

Material

Ball element with bolt

- Heat-treated steel, tempered, blackened

Lock nut

- Steel, blackened, DIN 934

Pad

- Heat-treated steel, blackened

More information

Notes

For the versions $d_1 = M10$ and $M12$ the lock nut conforms to DIN 934.

Drawing

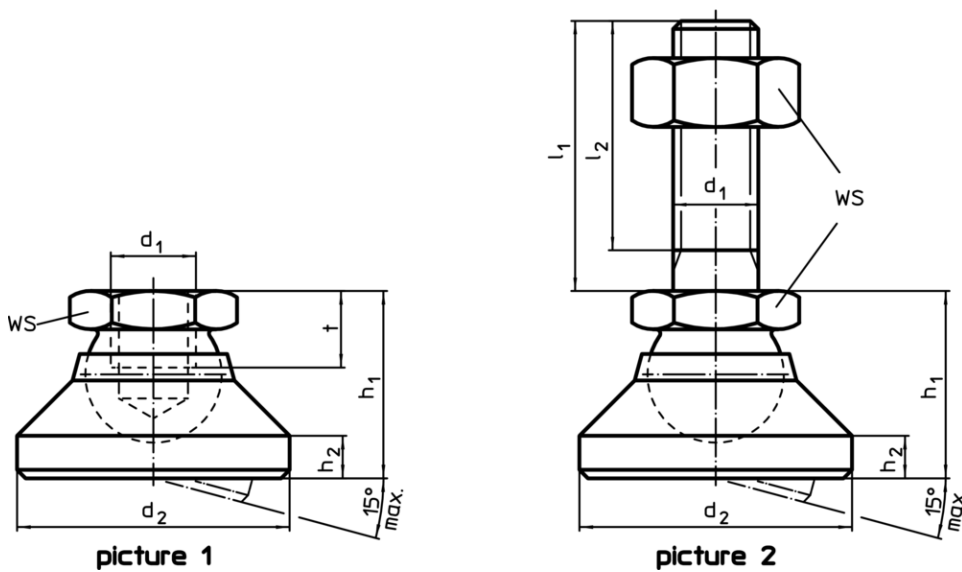

Order information

Dimensions						WS	Load capacity for static load max.	max.		Art. No.
d_1	l_1	d_2	l_2	h_1	h_2	[mm]	[kN]	[°C]	[g]	
[mm]						[mm]		[°C]	[g]	
pad and ball element with bolt from steel – picture 2, Heat-treated steel										
M12	100	40	94.5	26	6	19	35	250	237	22590.0452

Application example



Compliance

RoHS compliant

Compliant according to Directive 2011/65/EU and Directive 2015/863

Does not contain SVHC substances

No SVHC substances with more than 0.1% w/w contained - SVHC list [REACH] as of 10.06.2022

Does not contain Proposition 65 substances

No Proposition 65 substances included
<https://www.P65Warnings.ca.gov/>

Free from Conflict Minerals

This product does not contain any substances designated as "conflict minerals" such as tantalum, tin, gold or tungsten from the Democratic Republic of Congo or adjacent countries.