

Data sheet | Item number: 2060-952/030-000

Board-to-Board Link; Pin spacing 4 mm; 2-pole; Length: 30 mm; white

www.wago.com/2060-952/030-000

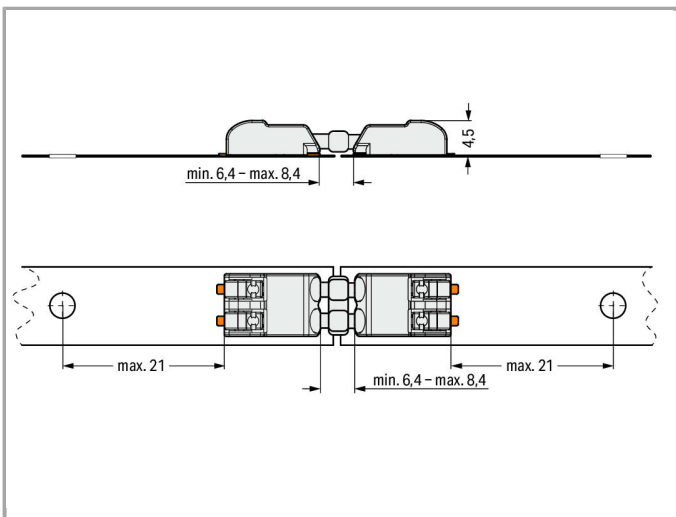
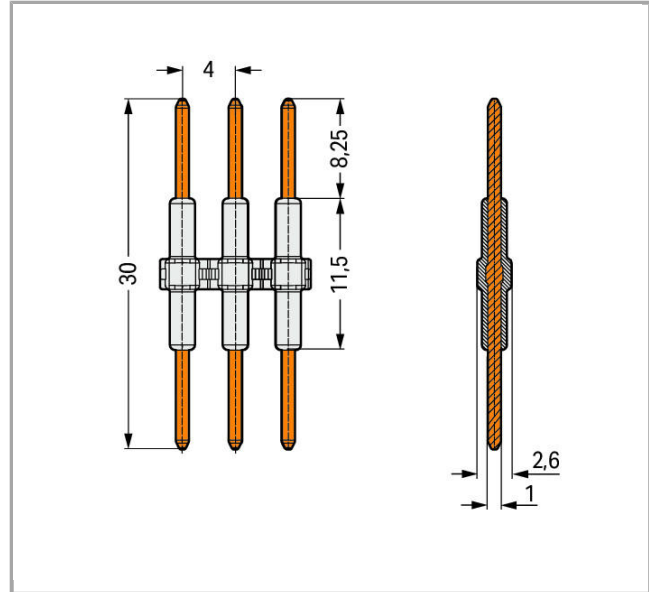
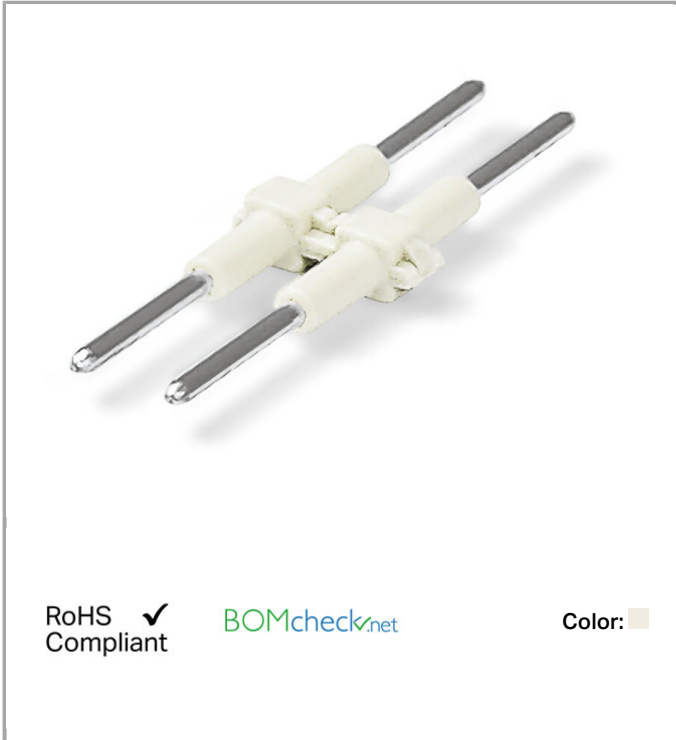

Item description

- Board-to-board link simplifies in-line assembly of LED modules
- Easy push-in termination and disconnection without push-button actuation

Data

Electrical data

Ratings per IEC/EN 60664-1

Rated voltage (III / 3)	63 V
Rated impulse voltage (III / 3)	2.5 kV
Rated voltage (III / 2)	160 V
Rated impulse voltage (III / 2)	2.5 kV
Rated voltage (II / 2)	320 V
Rated impulse voltage (II / 2)	2.5 kV
Rated current	9 A

Approvals per UL 1977

Rated voltage per UL 1977 (factory wiring only)	250 V
Rated current per UL 1977 (factory wiring only)	9 A

Connection data

Total number of potentials	2
Number of connection types	1
No. of poles	2

Geometrical Data

Pin spacing	4 mm / 0.157 inch
Width	7.4 mm / 0.291 inch
Height	2.6 mm / 0.102 inch
Depth	30 mm / 1.181 inch

Mechanical data

Mating cycles	10
Number of mating cycles	max. 10 mating cycles

Material Data

Color	white
Material group	I
Insulating material	Polyamide 66 (PA 66)
Flammability class per UL94	V0
Contact material	Copper alloy

Contact plating	silver-plated
Weight	0.49 g

Environmental Requirements







Limit temperature range	-60 ... +105 °C
-------------------------	-----------------

Commercial data

Country of origin	CN
GTIN	4055143339827
Customs Tariff No.	85369010000

Approvals / Certificates

Country specific Approvals

Logo	Approval	Additional Approval Text	Certificate name
	CCA DEKRA Certification B.V.	EN 60947	NTR NL-7724
	CCA DEKRA Certification B.V.	EN 60998	NTR NL-7725
	CCA DEKRA Certification B.V.	EN 60838	NTR NL-2168246
	KEMA/KEUR DEKRA Certification B.V.	EN 60838	2168246.01
	KEMA/KEUR DEKRA Certification B.V.	EN 60947	71-108183
	KEMA/KEUR DEKRA Certification B.V.	EN 60998	71-108181

UL-Approvals

Logo	Approval	Additional Approval Text	Certificate name
	cURus Underwriters Laboratories Inc.	UL 1977	E45171-20111005



Downloads

Documentation

Additional Information

Technical explanations

Apr 3, 2019

pdf
3.6 MB

Download

Subject to changes.

WAGO Kontakttechnik GmbH & Co. KG

Hansastr. 27

32423 Minden

Phone: +49571 887-0 | Fax: +49571 887-169

Email: info.de@wago.com | Web: www.wago.com

Do you have any questions about our products?

We are always happy to take your call at +49 (571) 887-44222.