



EVL8030-QJ-01A

IEEE 802.3af/at/bt-Compatible, PoE PD with PD Interface and SSR Forward Controller Evaluation Board

DESCRIPTION

The EVL8030-QJ-01A is an evaluation board designed to demonstrate the capabilities of the MP8030, a fully integrated, IEEE 802.3af/at/bt-compatible, Power over Ethernet (PoE), powered device (PD) with a PD interface and a high-efficiency forward controller.

The PD interface has all the functions of IEEE 802.3af/at/bt. It integrates a 100V hot-swap MOSFET and a gate driver (GATE1) to improve efficiency for high-powered applications. The second gate driver (GATE2) supports an

external, low $R_{DS(ON)}$ N-channel MOSFET to reduce high-power loss while the controller is powered from via adapter.

The controller is designed for both primary-side regulation (PSR) in flyback applications and secondary-side regulation (SSR) in active-clamped forward applications.

It is recommended to read the MP8030 datasheet prior to making any changes to the EVL8030-QJ-01A.

PERFORMANCE SUMMARY

Specifications are at $T_A = 25^\circ\text{C}$, unless otherwise noted.

Parameters	Conditions	Value
Input voltage (V_{IN}) range		41V to 57V
Output voltage (V_{OUT})	$V_{IN} = 41\text{V to }57\text{V}$, $I_{OUT} = 0\text{A to }14\text{A}$	5V
Maximum output current (I_{OUT})	$V_{IN} = 41\text{V to }57\text{V}$	14A
Full load efficiency	$V_{IN} = 54\text{V}$, $V_{OUT} = 5\text{V}$, $I_{OUT} = 14\text{A}$	92.2%
Switching frequency (f_{sw})		250kHz

EVALUATION BOARD

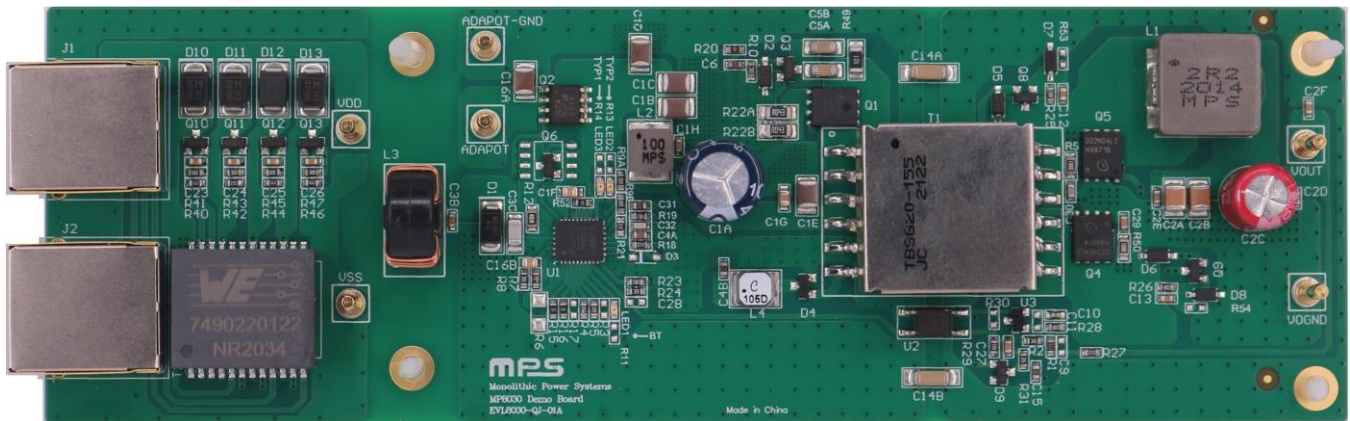

LxWxH (16.3cmx5.2cmx2cm)
4-Layers, 2oz/1oz/1oz/2oz

Board Number	MPS IC Number
EVL8030-QJ-01A	MP8030GQJ

QUICK START GUIDE

The EVL8030-QJ-01A is easy to set up to evaluate the performance of the MP8030. There are two methods to startup the EVL8030-QJ-01A, which are listed below. Figure 1 shows the connections for both methods.

Method 1:

1. Connect the load terminals to:
 - a. Positive (+): VOUT
 - b. Negative (-): VOGND
2. After making the connections, plug the Ethernet cable of the power-sourcing equipment (PSE) into the Ethernet jack (J1). The board should start up automatically.

Method 2:

1. Preset the power supply between 41V and 57V, then turn off the power supply.
2. Connect the power supply terminals to:
 - a. Positive (+): VDD
 - b. Negative (-): VSS
3. Connect the load terminals to:
 - a. Positive (+): VOUT
 - b. Negative (-): VOGND
4. After making the connections, turn on the power supply. The board should start up automatically.
5. The MP8030 is enabled once the VDD pin voltage (V_{DD}) is applied.

To use the adapter supply function, follow steps 6 and 7:

6. Connect the adapter terminals to:
 - a. Positive (+): ADAPOT
 - b. Negative (-): ADAPOT-GND
7. After making the connections, turn on the adapter. The board should be supplied via the adapter automatically.

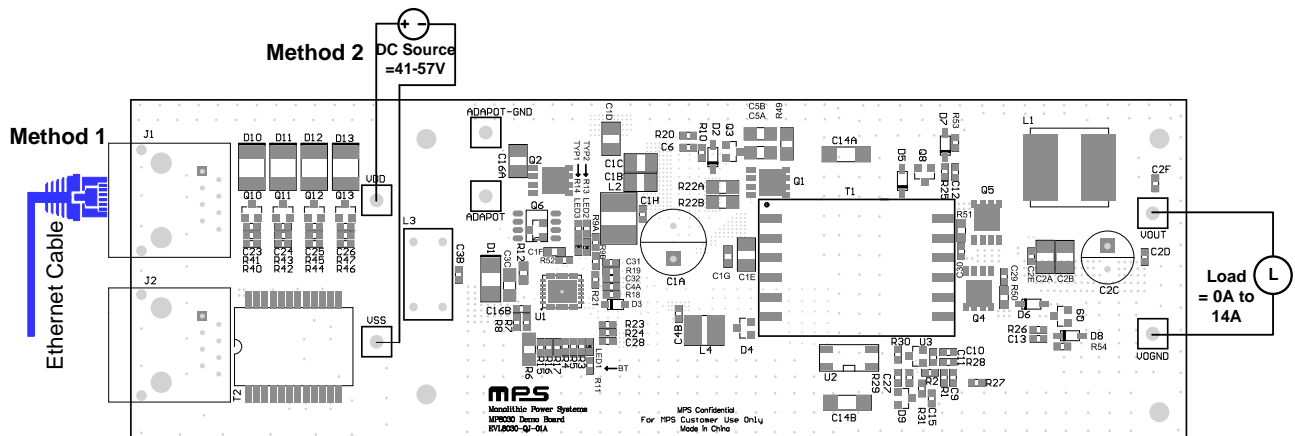

Figure 1: Ethernet Cable Supply or DC Source Supply Setup

EVALUATION BOARD SCHEMATIC

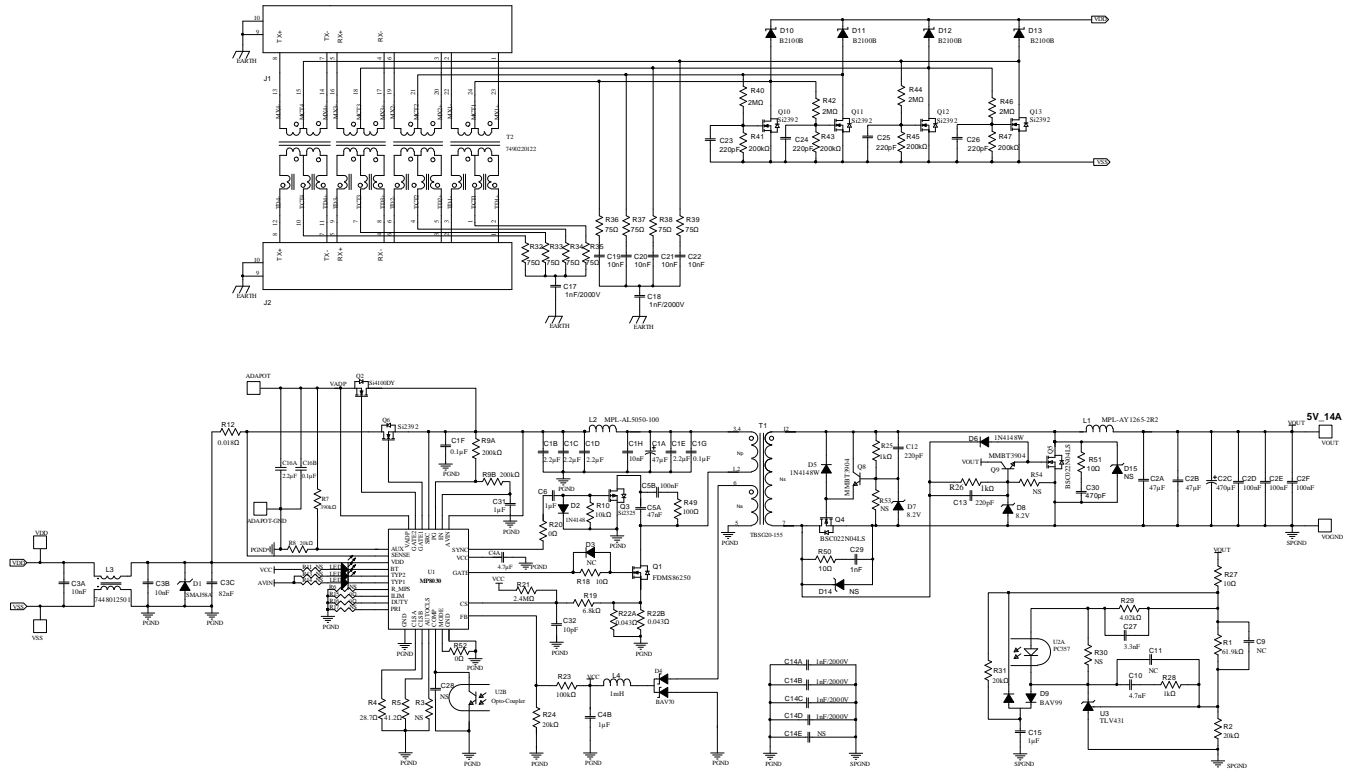

Figure 2: Evaluation Board Schematic (1) (2)

Notes:

- 1) R19 enables/disables frequency dithering. To disable frequency dithering, set R19 below 1kΩ. Choose R21 such that it maintains the original R21:R19 ratio (2.4MΩ:6.8kΩ).
- 2) To enable the LED indicator, set R11 to 9.09kΩ, R13 to 53.6kΩ, and R14 to 53.6kΩ. R11, R13, and R14 are not soldered onto the evaluation board by default.

EVL8030-QJ-01A BILL OF MATERIALS

Qty	Ref	Value	Description	Package	Manufacturer	Manufacturer PN
1	L1	2.2μH	Inductor, I _{RATED} = 17A, I _{SAT} = 26.5A, R _{DC} = 3.7mΩ	SMD	MPS	MPL-AY1265-2R2
1	L2	10μH	Inductor, I _{RATED} = 4.8A, I _{SAT} = 5.5A, R _{DC} = 37mΩ	SMD	MPS	MPL-AL5050-100
1	C1A	47μF	Electrolytic capacitor, 100V	DIP	Jianghai	ECR2AXY470MLB 100012
5	C1B, C1C, C1D, C1E, C16A	2.2μF	Ceramic capacitor, 100V, X7R	1210	Murata	GRM32ER72A225 KA88L
3	C1F, C1G, C16B	0.1μF	Ceramic capacitor, 100V, X7R	0805	Murata	GRM21BR72A104 KAC4L
3	C1H, C3A, C3B	10nF	Ceramic capacitor, 100V, X7R	0603	Murata	GRM188R72A103 KA01D
2	C2A, C2B	47μF	Ceramic capacitor, 10V, X7R	1210	Murata	GRM32ER71A476 KA88L
1	C2C	470μF	Electrolytic capacitor, 10V	DIP	Wurth	860080274011
3	C2D, C2E, C2F	100nF	Ceramic capacitor, 25V, X7R	0603	Murata	GRM188R71E104 KA01D
1	C3C	82nF	Ceramic capacitor, 100V, C0G	1206	Murata	GRM31C5C2A823 JA01L
1	C4A	4.7μF	Ceramic capacitor, 25V, X7R	0603	Murata	GRM188R71E475 KA01D
4	C4B, C31, C6, C15	1μF	Ceramic capacitor, 25V, X7R	0603	Murata	GRM188R71E105 KA01D
1	C5A	47nF	Ceramic capacitor, 250V, X7R	1206	Murata	GRM31CR72E473 KW03L
1	C5B	0.1μF	Ceramic capacitor, 250V, X7R	1206	Murata	GRM31CR72E104 KW03L
16	C9, C11, C28, C14E, D3, D14, D15, R3, R11, R13, R14, R17, R30, R53, R54	NS				
1	C10	4.7nF	Ceramic capacitor, 25V, X7R	0603	Murata	GRM188R71E472 KA01D
2	C12, C13	220pF	Ceramic capacitor, 50V, C0G	0603	Murata	GRM1885C1H221 JA01D
6	C14A, C14B, C14C, C14D, C17, C18	1nF	Ceramic capacitor, 2000V, X7R	1808	Murata	GR442QR73D102 KW01L
4	C19, C20, C21, C22	10nF	Ceramic capacitor, 100V, X7R	0603	Murata	GRM188R72A103 KA01D
4	C23, C24, C25, C26	220pF	Ceramic capacitor, 50V, X7R	0603	Murata	GRM188R71H221 KA01D

EVL8030-QJ-01A BILL OF MATERIALS (continued)

Qty	Ref	Value	Description	Package	Manufacturer	Manufacturer PN
1	C27	3.3nF	Ceramic capacitor, 25V, X7R	0603	Murata	GRM188R71E332 KA01D
1	C29	1nF	Ceramic capacitor, 100V, X7R	0603	Murata	GRM188R72A102 KA01D
1	C30	470pF	Ceramic capacitor, 100V, X7R	0603	Murata	GRM188R72A471 KA01D
1	C32	10pF	Ceramic capacitor, 50V, X7R	0603	Murata	GRM188R71H100 KA01D
1	D1	400W	TVS diode, 4.3A	SMA	Littelfuse Inc.	SMAJ58A
3	D2, D5, D6	100V	Diode switch, 400mW	SOD-123	Diodes Inc.	1N4148W-7-F
1	D4	70V	Series diode, 200mA, 350mW	SOT-23	On Semiconductor	BAV70
2	D7, D8	8.2V	Zener diode, 500mW	SOD-123	Diodes Inc.	BZT52C8V2-7
1	D9	70V	Series diode, 200mA, 350mW	SOT-23	Fairchild	BAV99
4	D10, D11, D12, D13	100V	Schottky diode, 2A	SMB	Diodes Inc.	B2100-13-F
2	J1, J2	1.5A	Jack connector, RJ45, 120V _{AC}	8P8C	Würth	615008140121
1	L3	1mH	Common mode choke, 2.5A 2 x 1mH, 2 x 55mΩ	7.5mmx 14mmx 16mm	Würth	7448012501
1	L4	1mH	Inductor, I _{RATED} = 0.1A, R _{DC} = 16.3mΩ	4.4mmx 4.4mmx 1.4mm	Coilcraft	LPS4414-105MLC
3	LED1, LED2, LED3	2.2V	Green LED, 20mA	0603	Rohm Semiconductor	SML-D12M8WT86
1	Q1	25mΩ	N-channel MOSFET, 150V, 6.7A	PQFN-8	On Semiconductor	FDMS86250
1	Q2	63mΩ	N-channel MOSFET, 100V, 6.8A	SOIC-8	Vishay	Si4100DY-T1-GE3
1	Q3	1.3Ω	P-channel MOSFET, -150V, -0.69A	SOT-23	Vishay	Si2325DS
2	Q4, Q5	2.2mΩ	N-channel MOSFET, 40V, 100A	TDSON-8	Infineon	BSC022N04LS
5	Q6, Q10, Q11, Q12, Q13	126mΩ	N-channel MOSFET, 100V, 3.1A	SOT-23	Vishay	Si2392DS-T1-GE3
2	Q8, Q9	40V	N-channel MOSFET, 200mA	SOT-23	Fairchild	MMBT3904
1	R1	61.9kΩ	Film resistor, 1%	0603	Yageo	RL0603FR- 0761K9L
4	R2, R8, R24, R31	20kΩ	Film resistor, 1%	0603	Yageo	RL0603FR-0720KL
1	R4	28.7Ω	Film resistor, 1%	0603	Yageo	RL0603FR- 0728R7T
1	R5	41.2Ω	Film resistor, 1%	0603	Yageo	RL0603FR- 0741R2T
1	R6	NS				
1	R7	390kΩ	Film resistor, 1%	0603	Yageo	RL0603FR- 07390KL

EVL8030-QJ-01A BILL OF MATERIALS (continued)

Qty	Ref	Value	Description	Package	Manufacturer	Manufacturer PN
6	R9A, R9B, R41, R43, R45, R47	200kΩ	Film resistor, 1%	0603	Yageo	RL0603FR-07200KL
1	R10	10kΩ	Film resistor, 1%	0603	Yageo	RL0603FR-0710KL
1	R12	0.018Ω	Film resistor, 1%	0805	Yageo	RL0805FR-070R018L
4	R15, R16, R20, R52	0Ω	Film resistor, 1%	0603	Yageo	RL0603FR-070RL
2	R18, R27	10Ω	Film resistor, 1%	0603	Yageo	RL0603FR-0710RL
1	R19	6.8kΩ	Film resistor, 1%	0603	Yageo	RL0603FR-076K8L
1	R21	2.4MΩ	Film resistor, 1%	0603	Yageo	RL0603FR-072M4L
2	R22A, R22B	0.043Ω	Film resistor, 1%	1206	Yageo	RL1206JR-070R043L
1	R23	100kΩ	Film resistor, 1%	0603	Yageo	RL0603FR-07100KL
3	R25, R26, R28	1kΩ	Film resistor, 1%	0603	Yageo	RL0603FR-071KL
1	R29	4.02kΩ	Film resistor, 1%	0603	Yageo	RL0603FR-074K02L
8	R32, R33, R34, R35, R36, R37, R38, R39	75Ω	Film resistor, 1%	0603	Yageo	RL0603FR-0775RL
4	R40, R42, R44, R46	2MΩ	Film resistor, 1%	0603	Yageo	RL0603FR-072ML
1	R49	100Ω	Film resistor, 1%	1206	Yageo	RL1206JR-07100RL
2	R50, R51	10Ω	Film resistor, 1%	0805	Yageo	RL0805FR-0710RL
1	T1	100μH	N _P :N _S :N _A = 16:4:8	EFD20	Chengdu Jingzhichuan	TBSG20-155
1	T2	350μH	LAN 10/100/1000 base-T transformer, WE-LAN series	SMD	Würth	7490220122
1	U2	50mA	Optocoupler	SMD	Sharp	PC357N2TJ00F
1	U3	1.24V	Low-voltage regulator, 18V, 70mA	SOT-23	NXP USA Inc.	TLVH431DQDB ZR215
1	U1	MP8030	PoE PD with high-efficiency flyback/forward controller	QFN-32 (5mmx6mm)	MPS	MP8030GQJ

EVB TEST RESULTS

Performance curves and waveforms are tested on the evaluation board. $V_{IN} = 54V$, $V_{OUT} = 5V$, $f_{SW} = 250kHz$, $T_A = 25^{\circ}C$, unless otherwise noted.

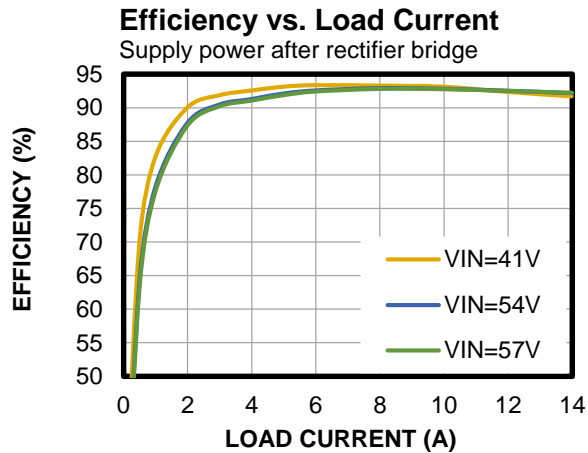

Thermal Performance

$I_{OUT} = 14A$, no forced airflow, $T_{AMBIENT} = 28^{\circ}C$, sp1 = MP8030, sp2 = Q1, sp3 = Q5

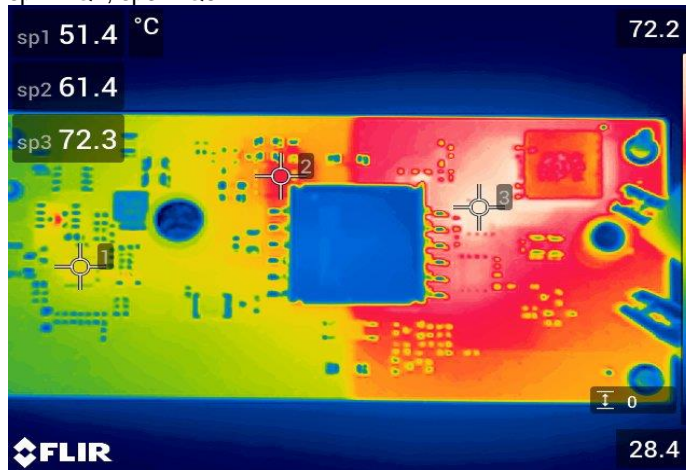

EVB TEST RESULTS *(continued)*

Performance curves and waveforms are tested on the evaluation board. $V_{IN} = 54V$, $V_{OUT} = 5V$, $f_{SW} = 250kHz$, $T_A = 25^{\circ}C$, unless otherwise noted.

Steady State and Output Voltage Ripple

$I_{OUT} = 14A$

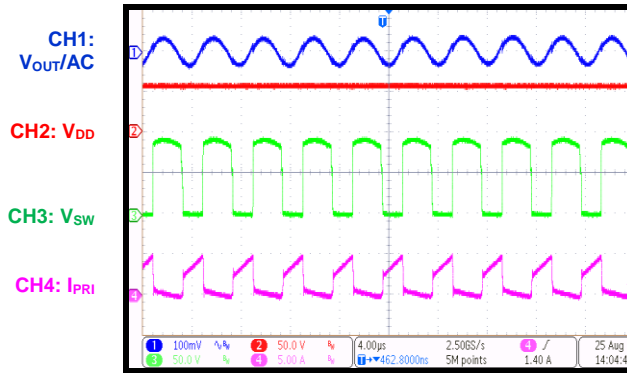

Load Transient Output Voltage Ripple

$I_{OUT} = 7A$ to $14A$, $25mA/\mu s$ slew rate, e-load

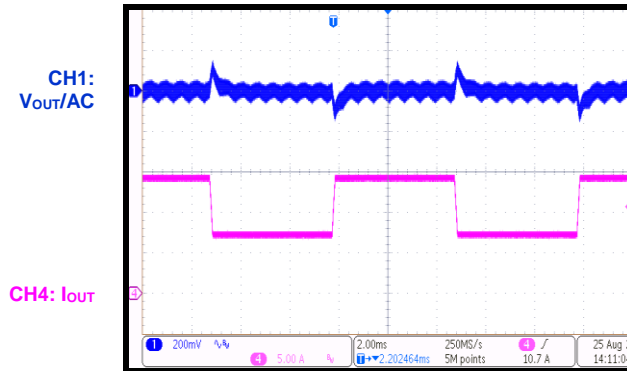

EVB TEST RESULTS *(continued)*

Performance curves and waveforms are tested on the evaluation board. $V_{IN} = 54V$, $V_{OUT} = 5V$, $f_{SW} = 250kHz$, $T_A = 25^{\circ}C$, unless otherwise noted.

Radiated Emissions

$I_{OUT} = 14A$

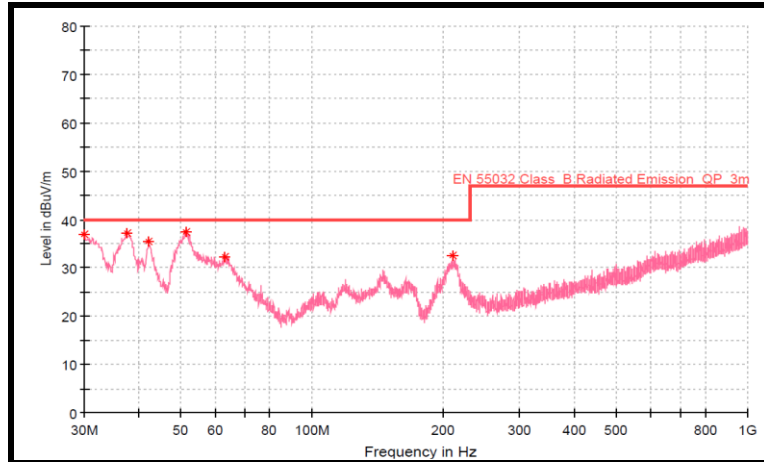

Conducted Emissions

$I_{OUT} = 14A$

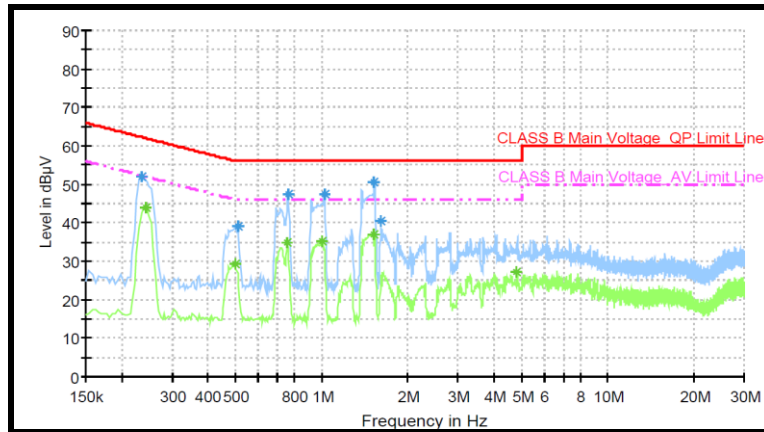

PCB LAYOUT (continued)

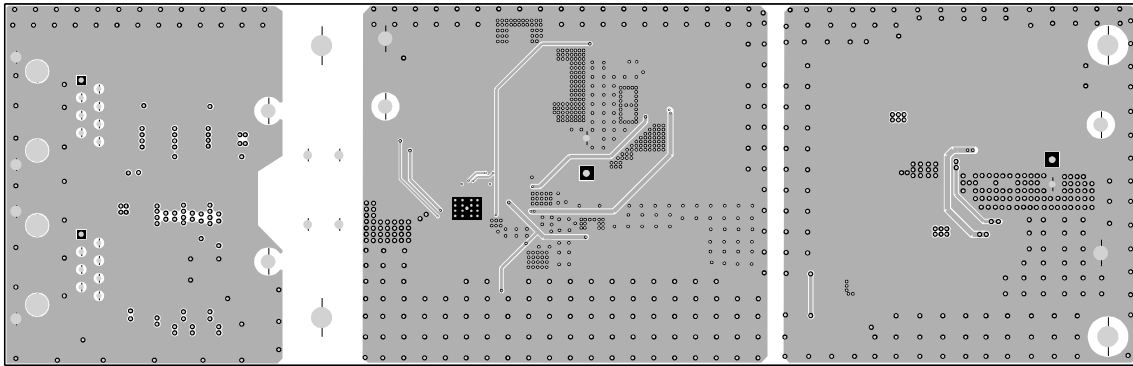

Figure 6: Mid-Layer 2

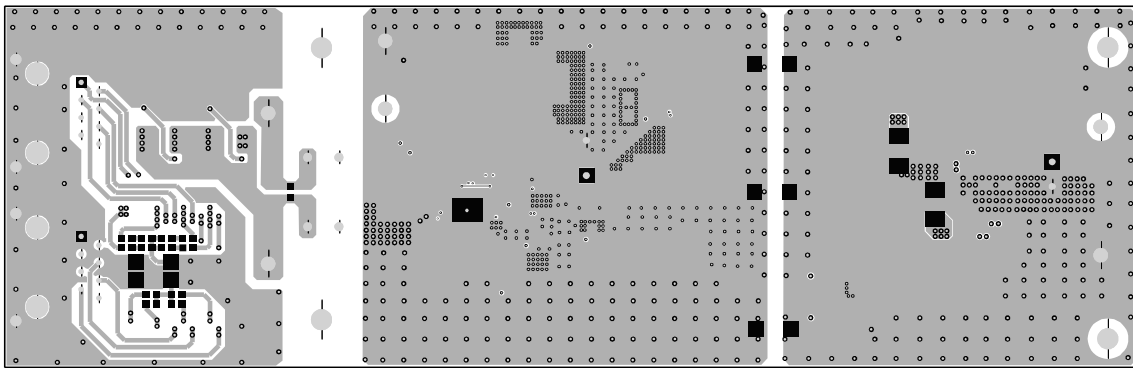

Figure 7: Bottom Layer

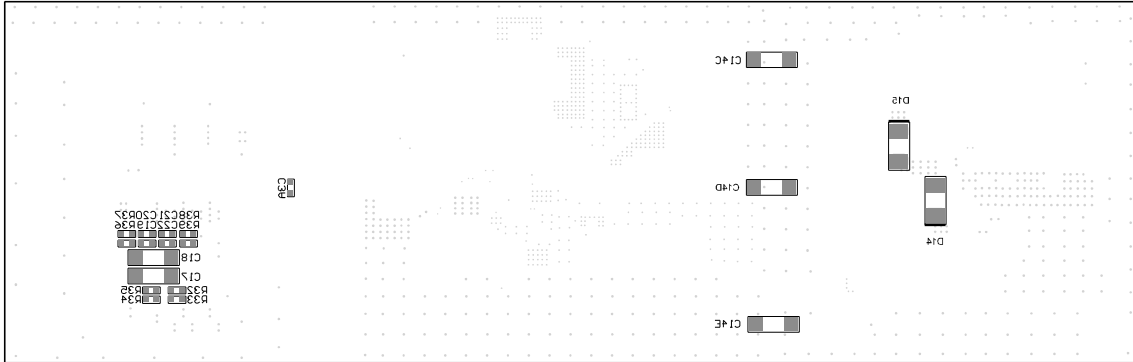

Figure 8: Bottom Silk

REVISION HISTORY

Revision #	Revision Date	Description	Pages Updated
1.0	10/25/2021	Initial Release	-

Notice: The information in this document is subject to change without notice. Please contact MPS for current specifications. Users should warrant and guarantee that third-party Intellectual Property rights are not infringed upon when integrating MPS products into any application. MPS will not assume any legal responsibility for any said applications.