

## 3-phase voltage monitoring relay (Multifunction)

EMR DU21C1, EMR DU21D1, EMR DU21B1



EMR DU21C1



EMR DU21D1

- Voltage monitoring in 3-phase mains
- Measuring range 66...115 / 132...230 / 230...400 Vac 3Ph
- Multifunction
- Monitoring of phase sequence and phase failure
- Additional asymmetry monitoring
- Connection of neutral wire optional
- 2 changers

### Functions

Voltage monitoring in 3-phase mains with adjustable thresholds, adjustable tripping delay, monitoring of phase sequence and phase failure, monitoring of asymmetry with adjustable threshold and the following functions (selectable by means of rotary switch)

- Undervoltage monitoring
- Undervoltage monitoring and monitoring of phase sequence
- Monitoring of window between Min and Max
- Monitoring the window between Min and Max and monitoring of phase sequence.

### Time ranges

Start-up suppression time: -  
Tripping delay: Adjustment range 0.1 ... 10 s

### Indicators

Red LED ON/OFF: indication of failure of the corresponding threshold  
Red LED flashes: indication of tripping delay of the corresponding threshold  
Yellow LED ON/OFF: indication of relay output

### Output relay

2 potential free change-over contacts  
Rated voltage: 250 Vac  
Switching capacity (distance <5 mm): 750 VA (3 A / 250 Vac)  
Switching capacity (distance >5 mm): 1250 VA (5 A / 250 Vac)  
Fusing: 5A fast acting

### Connecting voltages

24 ... 240 Vac/dc, Terminals A1-A2 (galvanically separated)  
Tolerance: 24 ... 240 Vdc, -20% ... +25% (galvanically separated)  
24 ... 240 Vac, -15% ... +10% (galvanically separated)  
100% duration of operation

### Reference data

Selectron® EMR	Article no.
DU21D1 230 ... 400 Vac 3Ph	41230002
DU21C1 132 ... 230 Vac 3Ph	41230003

(Order data see chapter 1)

## 3-phase voltage monitoring relay (Multifunction)

EMR DU21C1, EMR DU21D1, EMR DU21B1

Technical data	
Nominal consumption	3(N) ~132/230 V, 4,5 VA (1 W) (EMR DU21C1) 3(N) ~230/400 V, 4,5 VA (1 W) (EMR DU21D1) 3(N) ~ 66/115 V, 4,5 VA (1 W) (EMR DU21B1)
Nominal frequency	48 ... 400 Hz (24 ... 240 Vac) 16 ... 48 Hz (48 ... 240 Vac)
Wave form for ac	sine
Ripple at dc	10%
Drop-out voltage	>15% of the supply voltage
Base accuracy	±5% (of maximum scale value)
Adjustment accuracy	≤5% (of maximum scale value)
Repetition accuracy	≤2%
Temperature influence	≤0.1% / °C
Recovery time	500 ms
Measuring circuit:	Fusing: max. 20 A (according to UL 508)
	Measured variable: ac sine (48 ... 63 Hz)
	Input:
	3(N) ~132/230 V Terminals (N)-L1-L2-L3 (EMR DU21C1)
	3(N) ~230/400 V Terminals (N)-L1-L2-L3 (EMR DU21D1)
	3(N) ~ 66/115 V Terminals (N)-L1-L2-L3 (EMR DU21B1)
	Overload capacity:
	3(N) ~132/230 V 3(N) ~199/345 V (EMR DU21C1)
	3(N) ~230/400 V 3(N) ~346/600 V (EMR DU21D1)
	3(N) ~ 66/115 V 3(N) ~100/173 V (EMR DU21B1)
	Input resistance:
	3(N) ~132/230 V 470 kΩ (EMR DU21C1)
	3(N) ~230/400 V 1 MΩ (EMR DU21D1)
	3(N) ~ 66/115 V 220 kΩ (EMR DU21B1)
	Switching threshold:
	Max: -20% ... +30% von $U_N$
	Min: -30% ... +20% von $U_N$
	Asymmetry: 5% ... 25%

### Type key

EMR D U 2 1 C 1

#### Construction

**D** Industrial design 22.5 mm  
**S** pluggable 11 poles

#### Function

**U** Voltage  
**I** Current  
**P** CosPhi  
**T** Temperature  
**S** Star-Delta  
**F** Frequency

#### Output

**1** 1 changer  
**2** 2 changers  
**3** 1 NC contact / 1 NO contact

#### Special functions

**1** = Additional asymmetry monitoring

#### Measuring circuit

<b>A</b> No measuring circuit	<b>I</b> 12 Vdc
<b>B</b> 3(N)~115/66 Vac	<b>J</b> 24 Vdc
<b>C</b> 3(N)~230/132 Vac	<b>K</b> 36 Vdc
<b>D</b> 3(N)~400/230 Vac	<b>L</b> 48 Vdc
<b>E</b> 1 ≙ 30/60/300 Vac/dc	<b>M</b> 1~110 Vac
<b>F</b> 1 ≙ 100mA/1A/10A ac/dc	<b>N</b> 1~230 Vac
<b>G</b> PTC	<b>O</b> 1 A
<b>H</b> CosPhi	<b>P</b> 5 A
	<b>Q</b> 50/60 Hz 110... 400 Vac

#### Connecting voltage

**1** Measuring circuit  
**2** 24...240 Vac/dc  
**3** 230 Vac

## 3-phase voltage monitoring relay (Multifunction)

EMR DU21C1, EMR DU21D1, EMR DU21B1

### Function description

For all the functions the LEDs MIN and MAX are flashing alternating, when the minimum value for the measured voltage was chosen to be greater than the maximum value.

If a failure already exists when the device is activated, the output relays remain in off-position and the LED for the corresponding threshold is illuminated.

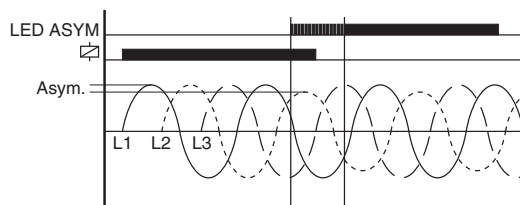
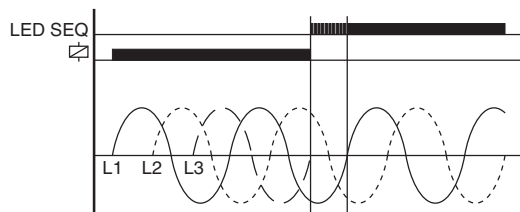
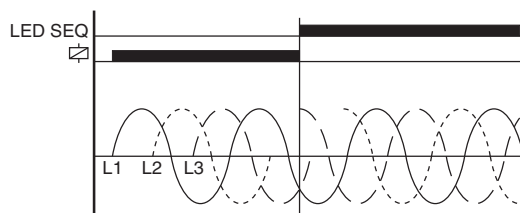
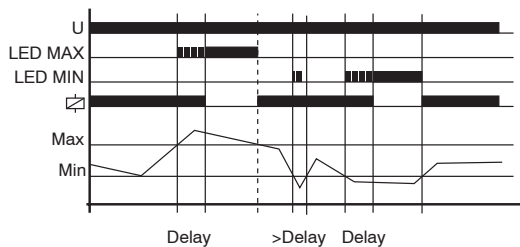
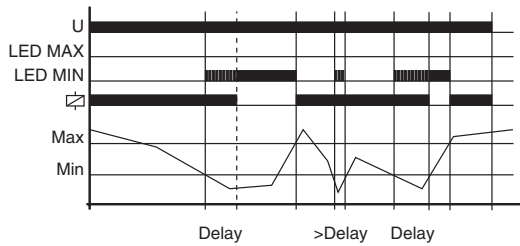

### Under voltage monitoring (UNDER, UNDER+SEQ)

When the measured voltage (mean value of phase-to-phase voltages) falls below the value adjusted at the MIN-regulator, the set interval of the tripping delay (DELAY) begins (red LED MIN flashes). After the interval has expired (red LED MIN illuminated), the output relays switch into off-position (yellow LED not illuminated). The output relays again switch into on-position (yellow LED illuminated), when the measured voltage exceeds the value adjusted at the MAX-regulator.

### Window function (WIN, WIN+SEQ)

The output relays switch into on-position (yellow LED illuminated) when the measured voltage (mean value of phase-to-phase voltages) exceeds the value adjusted at the MIN-regulator. When the measured voltage exceeds the value adjusted at the MAX-regulator, the set interval of the tripping delay (DELAY) begins (red LED MAX flashes). After the interval has expired (red LED MAX illuminated), the output relays switch into off-position (yellow LED not illuminated). The output relays again switch into on-position (yellow LED illuminated) when the measured voltage falls below the value adjusted at the MAX-regulator (red LED MAX not illuminated). When the measured voltage falls below the value adjusted at the MIN-regulator, the set interval of the tripping delay (DELAY) begins again (red LED MIN flashes). After the interval has expired (red LED MIN illuminated), the output relays switch into off-position (yellow LED not illuminated).

### Phase sequence monitoring (SEQ)

Phase sequence monitoring is selectable for all functions.

If a change in phase sequence is detected (red LED SEQ illuminated), the output relays switch into off-position immediately (yellow LED not illuminated).

### Phase failure monitoring (SEQ)

If one of the phase voltages fails, the set interval of the tripping delay (DELAY) begins (red LED SEQ flashes). After the interval has expired (red LED SEQ illuminated), the output relays switch into off-position (yellow LED not illuminated).

Reverse voltages of a consumer (e.g. a motor which continues to run on two phases only) do not effect the disconnection but can be monitored by using a proper value for the asymmetry.

### Asymmetry monitoring

If the asymmetry of the phase-to-phase voltages exceeds the value set at the ASYM-regulator, the set interval of the tripping delay (DELAY) begins (red LED ASYM flashes). After the interval has expired (red LED ASYM illuminated), the output relays switch into off-position (yellow LED not illuminated).

## 3-phase voltage monitoring relay (Multifunction)

EMR DU21C1, EMR DU21D1, EMR DU21B1

If the neutral wire is connected to the device, the asymmetry of the phase voltages referred to the neutral wire (Y-voltage) is monitored also. In that case both values of the asymmetry are evaluated and if one of the values exceeds the value set at the ASYM-regulator, the set interval of the tripping delay (DELAY) begins (red LED ASYM flashes). After the interval has expired (red LED ASYM illuminated), the output relays switch into off-position (yellow LED not illuminated).

### Loss of neutral wire by means of evaluation of asymmetry

A break of the neutral wire between power line and machinery is detected as soon as asymmetry between phase-to-phase voltage and neutral wire occurs. If the asymmetry exceeds the value set at the ASYM-regulator, the set interval of the tripping delay (DELAY) begins (red LED ASYM flashes). After the interval has expired (red LED ASYM illuminated), the output relays switch into off-position (yellow LED not illuminated). A break of the neutral wire between our device and the machinery can not be detected.

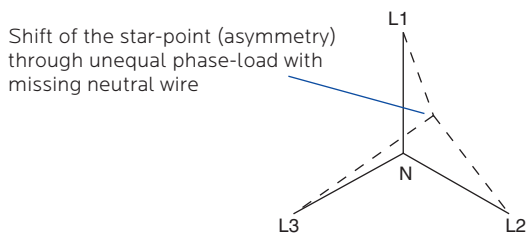

## Connection

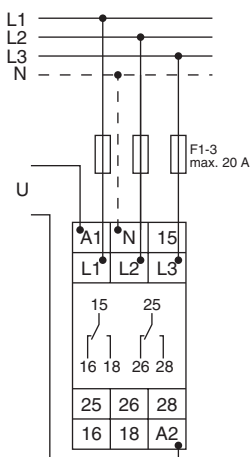

Supply voltage 24 ... 240 Vac/dc

## Dimensions

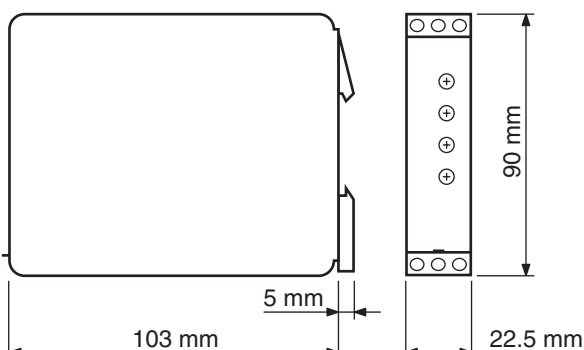

## Technical safety advice

This manual contains the information necessary for the correct utilisation of the products described therein. It is intended for technically qualified persons who are involved as either

- planning engineers familiar with the safety concepts of automation technology;
- or, operating personnel, who have been instructed in handling automation equipment and have a knowledge of the contents of this manual concerning operation;
- or, installation and servicing personnel possessing the necessary training to repair such an automation system or who have the authority to put such circuits and equipment/systems into operation, to earth or label them according to the relevant safety standards.

The products are constructed, manufactured and tested in compliance with the relevant VDE standards, VDE specifications and IEC recommendations.

### Danger warning

These warnings serve both as a guide for those persons involved in a project and as safety advice to prevent damage to the products themselves or to associated equipment.

Due to advancements in technology, the wiring diagram on the actual device may be different than shown in this catalogue. In all instances where the actual device diagram is different, the wiring diagram on the device must be used when electrical connections are made.

### Correct utilisation, configuration and assembly

The equipment is to be used only for the applications stated in the catalogue and technical literature, and only in conjunction with auxiliary equipment and devices that are recommended or approved by Selectron Systems Ltd.

Further, it should be noted that:

- the automation equipment must be disconnected from any power supply before it is assembled, disassembled or the configuration modified.
- Solid state electronic switches must not be tested with incandescent lamps or connected to a load that exceeds its rating.
- trouble-free and safe operation of the

products requires correct transportation as well as appropriate storage, assembly and wiring.

- the systems may only be installed by trained personnel. In doing so, the relevant requirements contained in VDE 0100, VDE 0113, IEC 364, etc. must be complied with.

### Prevention of material damage or personal injury

Additional external safety devices or facilities must be provided wherever significant material damage or even personal injury could result from a fault occurring in an automation system. A defined operating status must be ensured or forced by such devices or facilities (e.g. by independent limit switches, mechanical interlocks, etc.).

### Advice concerning planning and installation of the products

- The safety and accident prevention measures applicable to a specific application are to be observed.
- In the case of mains-operated equipment, a check is to be made before putting it into operation to ensure that the preset mains voltage range is suitable for the local supply.
- In the case of a 24 V supply, care must be taken to ensure sufficient electrical insulation of the secondary side. Use only mains power supply units that conform to IEC 364-4-41 or HD 384.04.41 (VDE 0100 Part 410).
- Automation systems and their operating elements are to be installed in such a way that they are sufficiently protected against accidental operation.

### Warranty

Selectron Systems Ltd. warrants its products to be free from defects in material and workmanship for a period of one year from the date of shipment. All claims under this warranty must be made within thirty (30) days of the discovery of the defect, and all defective products must be returned at the buyer's expense. Buyer's sole and exclusive right will be limited to, at the option of Selectron Systems Ltd., the repair or replacement by Selectron Systems Ltd., of any defective products for which a claim is made.

In all other matters please refer to the "General terms of business" concerning Selectron Systems Ltd.

### Note

The information given in this documentation corresponds to the state of development at the time of going to press and is therefore not binding. Selectron Systems Ltd. reserves the right to make alterations in the interests of technical advancement or product improvement at any time without giving reasons for doing so.

## Prescriptions and standards

<b>Mechanical data</b>	
Housings in self-extinguishing plastic material. Protection mode IP 40	
Mounting: snapping mode:	Fixing on profile rail according DIN 46277/3 (EN 50 022)
Connection	via contact protected terminals up to 4 mm <sup>2</sup> , protecting mode IP 20
<b>Environmental conditions</b>	
Admissible environmental temperatures from -25 °C ... +55 °C (corresponds IEC 68-1)	
Storage and transport temperature from -25 °C ... +70 °C	
Application class	IEC 721-3-3 (EN 60721-3-3)
<b>Output relay</b>	
Electrical lifetime:	230 Vac, min. 2x10 <sup>5</sup> switching cycles at 1000 VA ohmic load.
Mechanical lifetime:	min. 20 x 10 <sup>6</sup> switching cycles
Contact material	AgNi
Frequency range	48 ... 400 Hz / 24 ... 240 Vac, 16 ... 48 Hz / 24 ... 48 Vac
Duration of operation	100%
<b>Protection</b>	
Protection of the unit	5 A fast
<b>Terminals</b>	
Contact protection according VDE 0106 and VBG 4	
Terminal type:	sleeve with indirect screw pressure
Wire to connect:	rigid or flexible
Connecting limit:	4 mm <sup>2</sup>
Terminal variants:	1 wire 0,5 mm <sup>2</sup> ... 2,5 mm <sup>2</sup> with/without wire end covers
	1 wire 4 mm <sup>2</sup> without wire end covers
	2 wires 0,5 mm <sup>2</sup> ... 1,5 mm <sup>2</sup> with/without wire end covers
	2 wires 2,5 mm <sup>2</sup> flexible without wire end covers
max. screw in torque:	1,0 Nm
Terminal screw for screw driver with PZ-1	
<b>Insulation</b>	
Isolation nominal voltage:	250 Vac (corresponds to IEC 60664-1)
Rating surge voltage:	4 kV, over-voltage category III, corresponds to IEC 60664-1
<b>Electromagnetic compatibility</b>	
Electrostatic discharge: Level 3, 6 kV contact, 8 kV air (corresponds to IEC 1000-4-2)	
High frequency electromagnetic fields: Level 3, 10 V/m (corresponds to IEC 1000-4-3)	
Fast transients: Level 4, 4 kV / 2,5 kHz, 5/50 ns (corresponds to IEC 1000-4-4)	
Lightning discharge: Level 3, 2 kV com., 1 kV dif., (corresponds to IEC 1000-4-5)	
Cable running disturbances inducted by HF fields: Level 3, 10 V RMS (corresponds to IEC 1000-4-6)	
Spurious radiation net and aerial network: Class B (corresponds to CISPR 22)	
<b>Prescriptions</b>	
Air and leakage paces:	VDE 0110iGr. C/250
Test voltage:	VDE 0435 2000Vac
Low voltage directions according to IEC 664-1	
EMC emissions:	EN 50 081-1 and EN 55 022 class B
EMC interference stability:	Voltage impact strength according to IEC 1000-4-5
Burst:	EN 50 082-2, EN 61 812-1 (level 3)
ESD:	IEC 1000-4-2
HF over metallic circuits:	EN 50 082-2, ENPr 50141
Electro magnetic HF field according to EN 50 082-2, ENPr 50140 and ENPr 50204	
Production standard:	according to ISO 9001