

Adjustable Flat Tension Levers • with screw, stainless steel

24441.1690



Product Description

Adjustable flat tension levers are used when the swivel range is limited or a specific lever position is required.

Adjustable flat tension levers are characterised by their low construction height and are particularly suitable for use in restricted spaces or when the lever should not overhang..

Material

Lever

- Zinc die-cast, plastic coated, silver, similar to RAL 9006, matt structure

Inner parts

- Stainless steel 1.4305

Screw

- Stainless steel 1.4305

Covering

- Plastic, light grey

Operation

By lifting the lever the serrations are disengaged. The lever can be positioned by the serrations. On releasing the lever, the serrations are automatically re-engaged.

Drawing

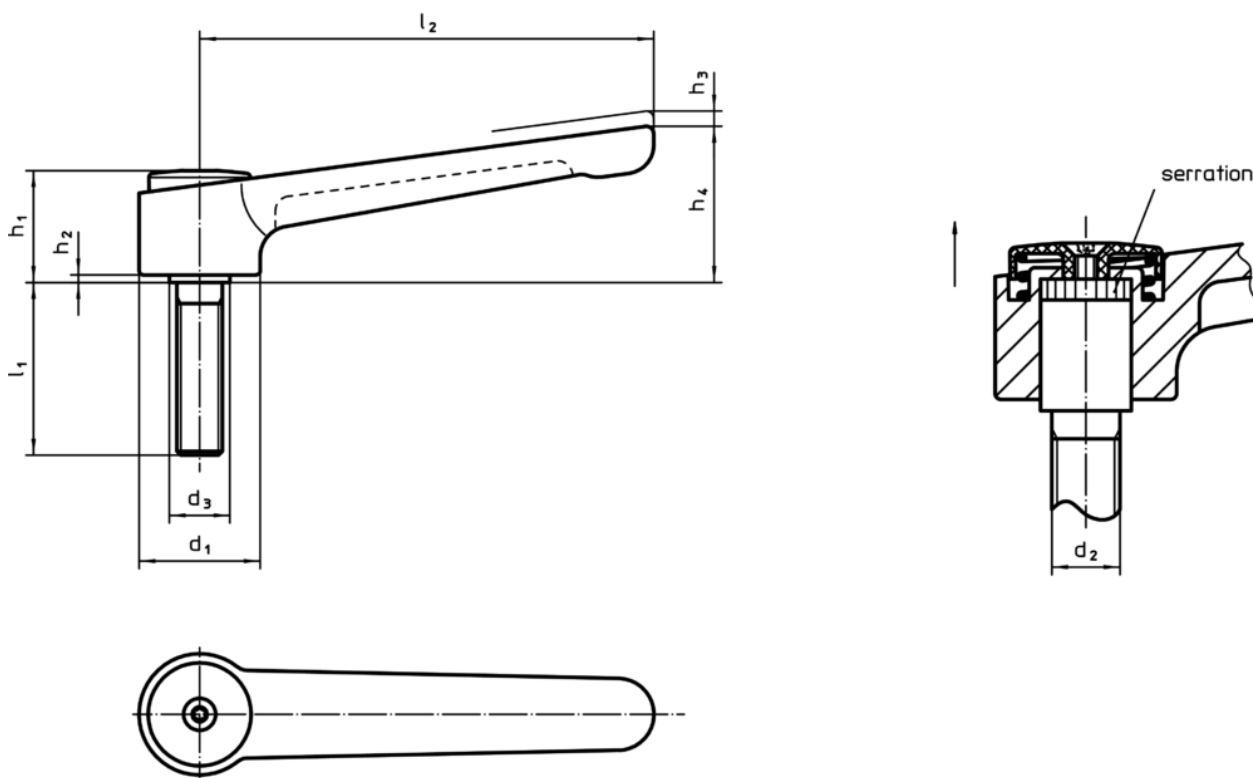

Order information

Dimensions									Temperature		Weight	Art. No.	
d ₁	d ₂	l ₁	d ₃	h ₁	h ₂	h ₃	h ₄	l ₂	min.	max.	[g]		
[mm]									[°C]				
silver													
32	M12	25	16	29.5	2	2.5	41.5	120	-30	80	210	24441.1690	

Compliance

RoHS compliant

Compliant according to Directive 2011/65/EU and Directive 2015/863

Does not contain SVHC substances

No SVHC substances with more than 0.1% w/w contained - SVHC list [REACH] as of 10.06.2022

Does not contain Proposition 65 substances

No Proposition 65 substances included
<https://www.P65Warnings.ca.gov/>

Free from Conflict Minerals

This product does not contain any substances designated as "conflict minerals" such as tantalum, tin, gold or tungsten from the Democratic Republic of Congo or adjacent countries.