

U-Handles · with support washer

24310.0660



Product Description

U-handles are used, for example, on machine doors, furniture doors, cabinet doors, drawers and drawer units.

These rounded U-handles are characterised by their ergonomic and stable construction and their simple and timeless design.

Material

Handle

- Stainless steel 1.4305, dull blasted

Support washer

- stainless steel

Assembly

The supporting washer provides a good bearing surface. Suitable washers are joined in loose form.

Drawing

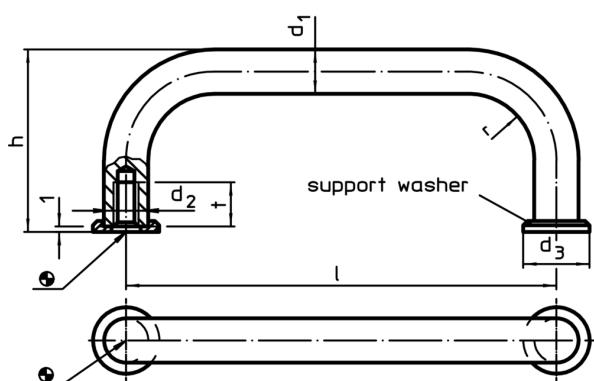

Order information

d ₁	l ±0.5	d ₂	Dimensions				t min.	[g]	Art. No.
			d ₃	h	r	[mm]			
stainless steel									
10	200	M5	15	43	12	12	161	24310.0660	

Compliance

RoHS compliant

Compliant according to Directive 2011/65/EU and Directive 2015/863

Does not contain SVHC substances

No SVHC substances with more than 0.1% w/w contained - SVHC list [REACH] as of 10.06.2022

Does not contain Proposition 65 substances

No Proposition 65 substances included

<https://www.P65Warnings.ca.gov/>

Free from Conflict Minerals

This product does not contain any substances designated as "conflict minerals" such as tantalum, tin, gold or tungsten from the Democratic Republic of Congo or adjacent countries.