

MJE15034 (NPN), MJE15035 (PNP)

Complementary Silicon Plastic Power Transistors

TO-220, NPN & PNP Devices

Complementary silicon plastic power transistors are designed for use as high-frequency drivers in audio amplifiers.

Features

- High Current Gain – Bandwidth Product
- TO-220 Compact Package
- Epoxy meets UL 94 V-0 @ 0.125 in
- These Devices are Pb-Free and are RoHS Compliant*

MAXIMUM RATINGS

Rating	Symbol	Value	Unit
Collector-Emitter Voltage	V_{CEO}	350	Vdc
Collector-Base Voltage	V_{CB}	350	Vdc
Emitter-Base Voltage	V_{EB}	5.0	Vdc
Collector Current – Continuous	I_C	4.0	Adc
Collector Current – Peak	I_{CM}	8.0	Adc
Base Current	I_B	1.0	Adc
Total Power Dissipation @ $T_C = 25^\circ\text{C}$ Derate above 25°C	P_D	50 0.40	W W/ $^\circ\text{C}$
Total Power Dissipation @ $T_A = 25^\circ\text{C}$ Derate above 25°C	P_D	2.0 0.016	W W/ $^\circ\text{C}$
Operating and Storage Junction Temperature Range	T_J, T_{stg}	-65 to +150	$^\circ\text{C}$
ESD – Human Body Model	HBM	3B	V
ESD – Machine Model	MM	C	V

Stresses exceeding those listed in the Maximum Ratings table may damage the device. If any of these limits are exceeded, device functionality should not be assumed, damage may occur and reliability may be affected.

THERMAL CHARACTERISTICS

Characteristic	Symbol	Max	Unit
Thermal Resistance, Junction-to-Case	$R_{\theta JC}$	2.5	$^\circ\text{C/W}$
Thermal Resistance, Junction-to-Ambient	$R_{\theta JA}$	62.5	$^\circ\text{C/W}$

*For additional information on our Pb-Free strategy and soldering details, please download the ON Semiconductor Soldering and Mounting Techniques Reference Manual, SOLDERRM/D.

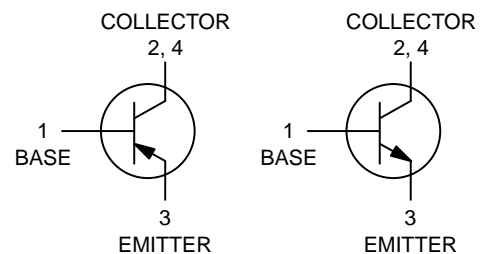


ON Semiconductor®

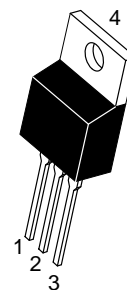
www.onsemi.com

4.0 AMPERES POWER TRANSISTORS COMPLEMENTARY SILICON 350 VOLTS, 50 WATTS

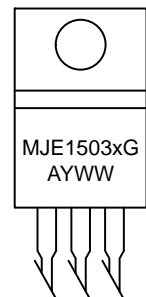
COMPLEMENTARY



MARKING DIAGRAM



TO-220
CASE 221A
STYLE 1



MJE1503x = Device Code
 x = 4 or 5
A = Location Code
Y = Year
WW = Work Week
G = Pb-Free Package

ORDERING INFORMATION

Device	Package	Shipping
MJE15034G	TO-220 (Pb-Free)	50 Units / Rail
MJE15035G	TO-220 (Pb-Free)	50 Units / Rail

MJE15034 (NPN), MJE15035 (PNP)

ELECTRICAL CHARACTERISTICS ($T_C = 25^\circ\text{C}$ unless otherwise noted)

Characteristic	Symbol	Min	Max	Unit
----------------	--------	-----	-----	------

OFF CHARACTERISTICS

Collector-Emitter Sustaining Voltage (Note 1)	($I_C = 10\text{ mAdc}, I_B = 0$)	$V_{CEO(sus)}$	350	-	Vdc
Collector Cutoff Current	($V_{CB} = 350\text{ Vdc}, I_E = 0$)	I_{CBO}	-	10	μAdc
Emitter Cutoff Current	($V_{BE} = 5.0\text{ Vdc}, I_C = 0$)	I_{EBO}	-	10	μAdc

ON CHARACTERISTICS (Note 1)

DC Current Gain	($I_C = 0.1\text{ Adc}, V_{CE} = 5.0\text{ Vdc}$) ($I_C = 0.5\text{ Adc}, V_{CE} = 5.0\text{ Vdc}$) ($I_C = 1.0\text{ Adc}, V_{CE} = 5.0\text{ Vdc}$) ($I_C = 2.0\text{ Adc}, V_{CE} = 5.0\text{ Vdc}$)	h_{FE}	100 100 50 10	- - - -	-
Collector-Emitter Saturation Voltage	($I_C = 1.0\text{ Adc}, I_B = 0.1\text{ Adc}$)	$V_{CE(sat)}$	-	0.5	Vdc
Base-Emitter On Voltage	($I_C = 1.0\text{ Adc}, V_{CE} = 5.0\text{ Vdc}$)	$V_{BE(on)}$	-	1.0	Vdc

DYNAMIC CHARACTERISTICS

Current Gain - Bandwidth Product (Note 2) ($I_C = 500\text{ mAdc}, V_{CE} = 10\text{ Vdc}, f_{test} = 1.0\text{ MHz}$)	f_T	30	-	MHz
---	-------	----	---	-----

Product parametric performance is indicated in the Electrical Characteristics for the listed test conditions, unless otherwise noted. Product performance may not be indicated by the Electrical Characteristics if operated under different conditions.

1. Pulse Test: Pulse Width $\leq 300\ \mu\text{s}$, Duty Cycle $\leq 2.0\%$.
2. $f_T = |h_{fe}| \cdot f_{test}$.

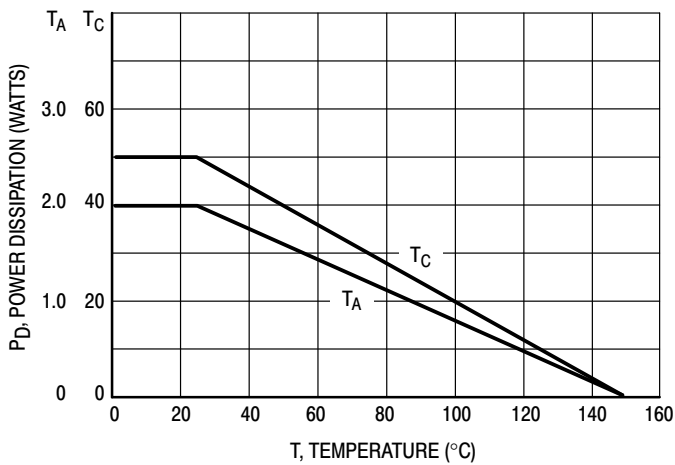


Figure 1. Power Derating

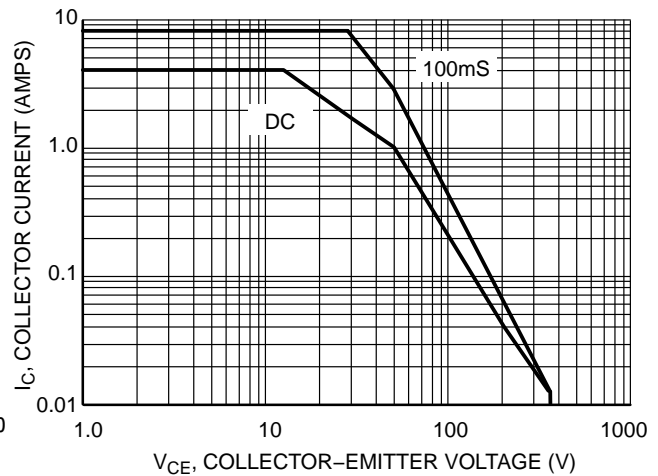


Figure 2. Active Region Safe Operating Area

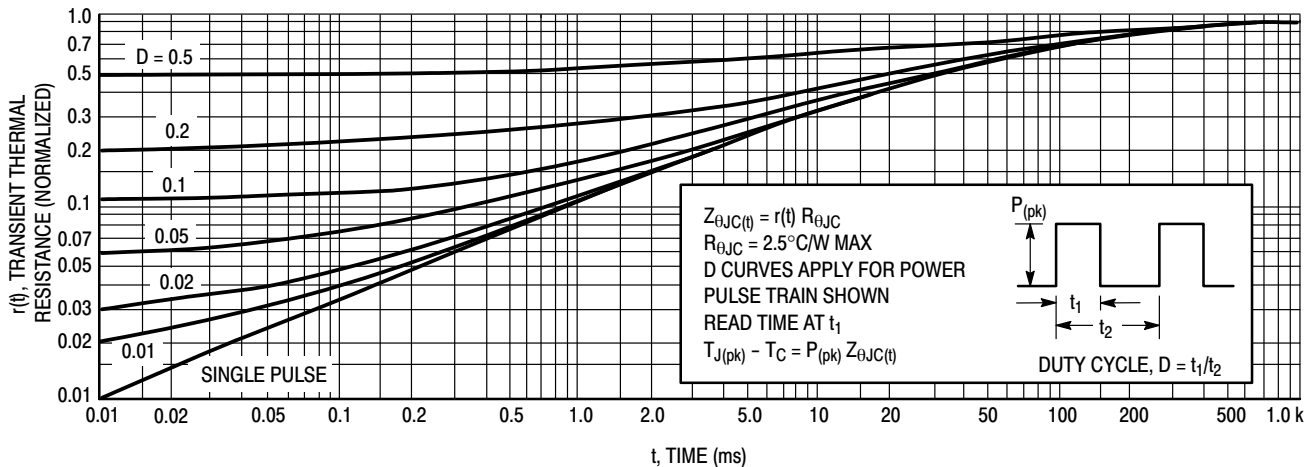
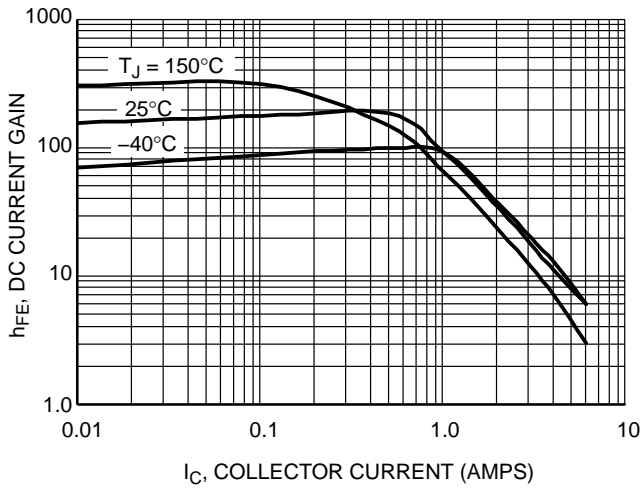
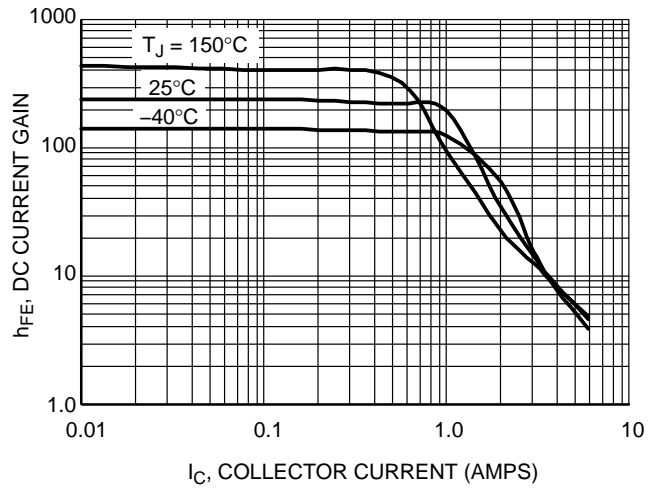


Figure 3. Thermal Response

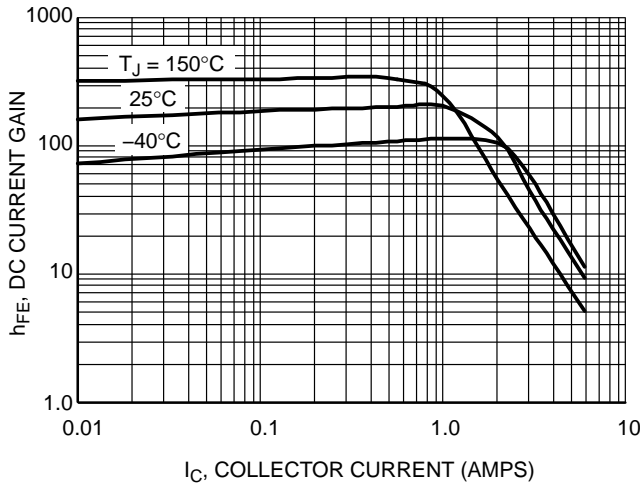
MJE15034 (NPN), MJE15035 (PNP)



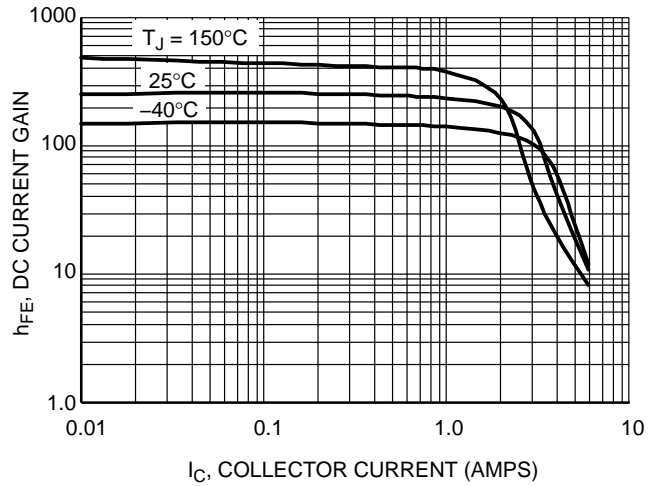
**Figure 4. DC Current Gain, $V_{CE} = 5.0$ V
NPN MJE15034**



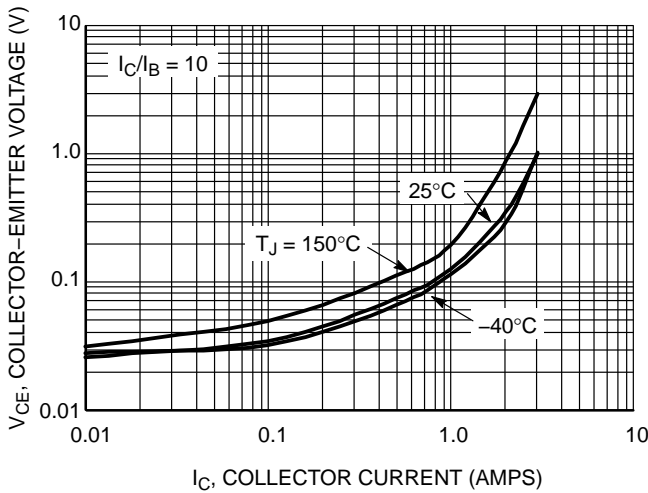
**Figure 5. DC Current Gain, $V_{CE} = 5.0$ V
PNP MJE15035**



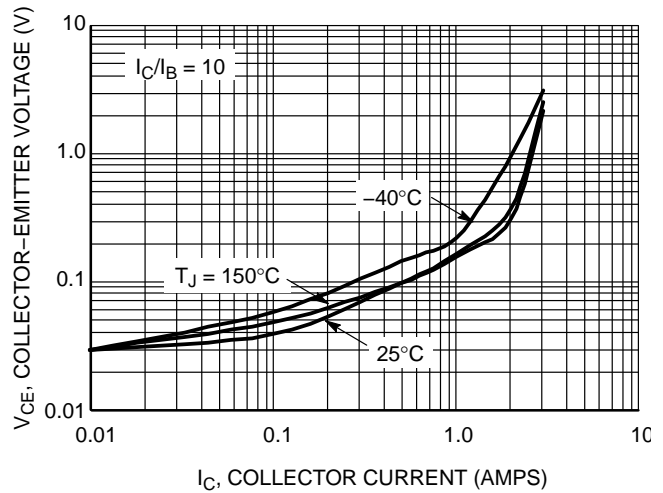
**Figure 6. DC Current Gain, $V_{CE} = 20$ V
NPN MJE15034**



**Figure 7. DC Current Gain, $V_{CE} = 20$ V
PNP MJE15035**

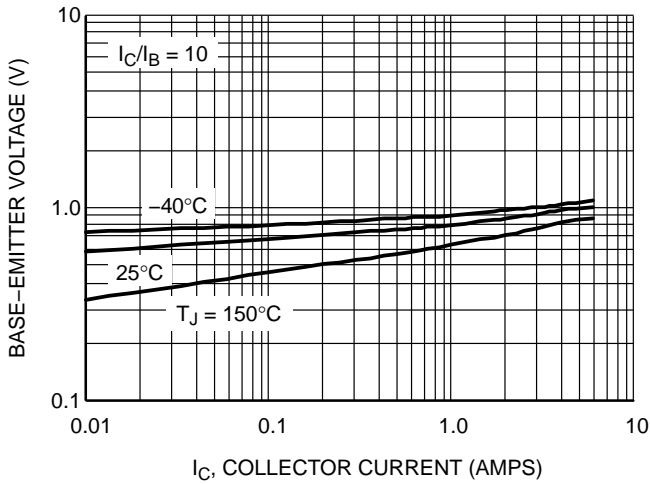


**Figure 8. $V_{CE(sat)}$
NPN MJE15034**

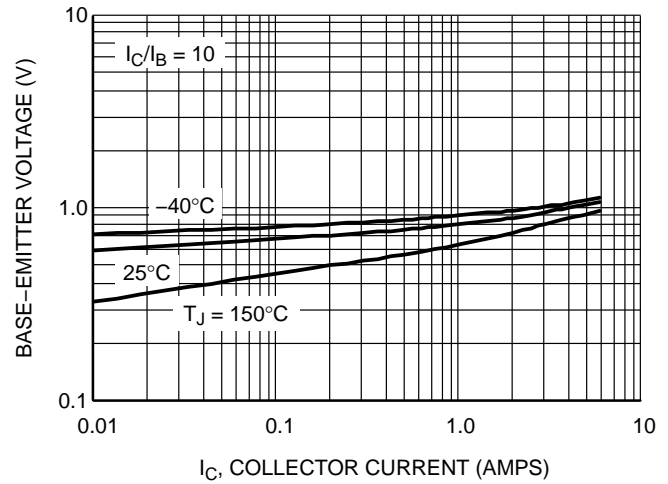


**Figure 9. $V_{CE(sat)}$
PNP MJE15035**

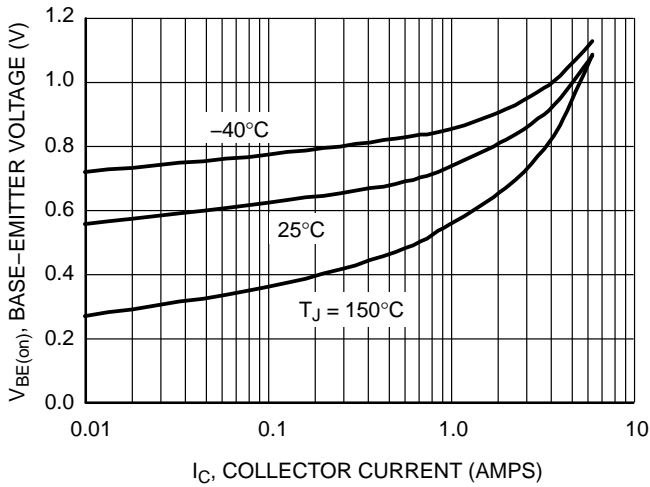
MJE15034 (NPN), MJE15035 (PNP)



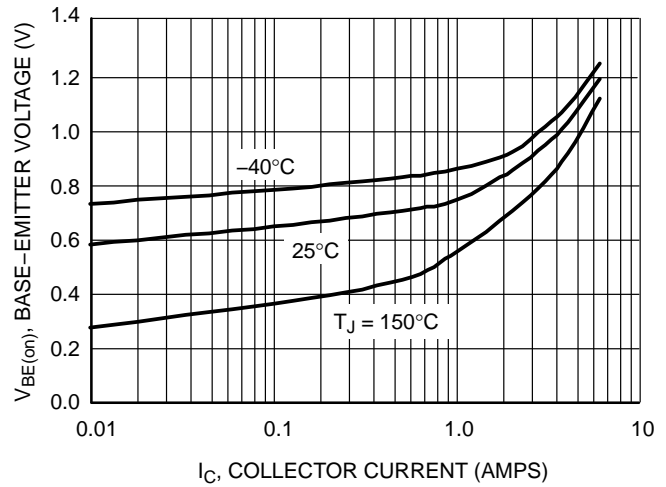
**Figure 10. $V_{BE(sat)}$
NPN MJE15034**



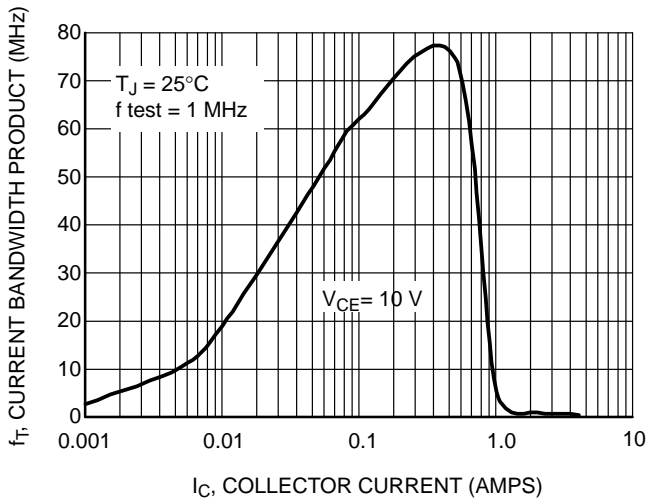
**Figure 11. $V_{BE(sat)}$
PNP MJE15035**



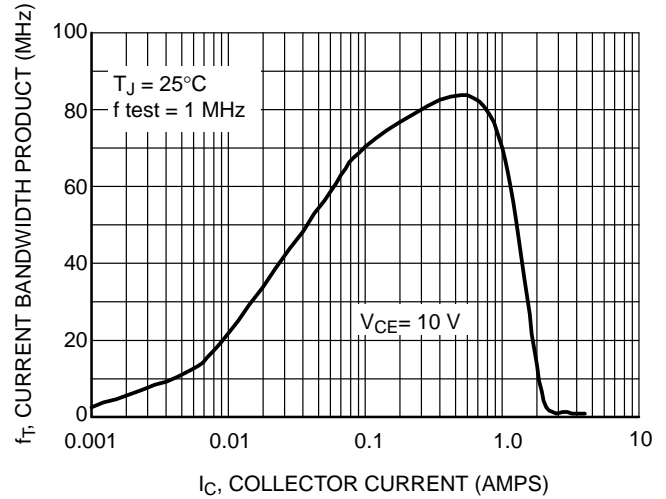
**Figure 12. $V_{BE(on)}$
NPN MJE15034**



**Figure 13. $V_{BE(on)}$
PNP MJE15035**



**Figure 14. Typical Current Gain Bandwidth Product
NPN MJE15034**



**Figure 15. Typical Current Gain Bandwidth Product
PNP MJE15035**

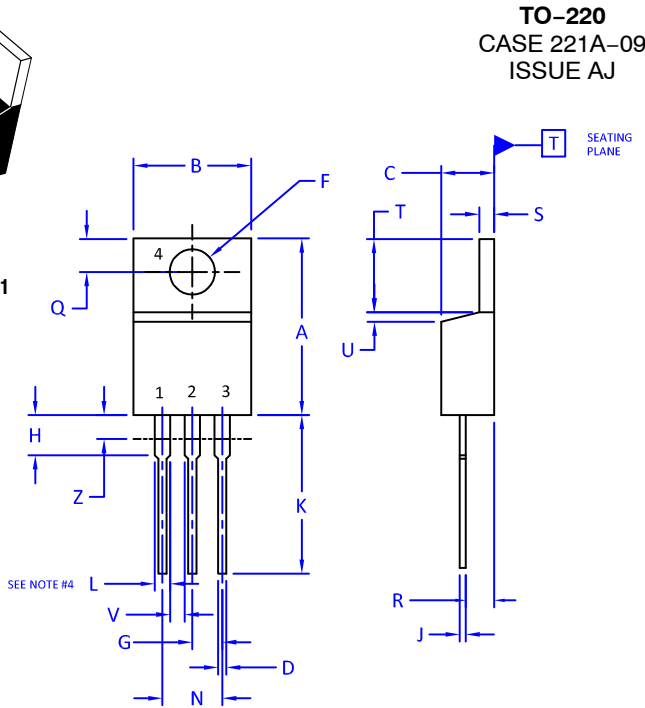
MECHANICAL CASE OUTLINE

PACKAGE DIMENSIONS

ON Semiconductor®



SCALE 1:1



TO-220
CASE 221A-09
ISSUE AJ

DATE 05 NOV 2019

NOTES:

1. DIMENSIONING AND TOLERANCING PER ANSI Y14.5M, 2009.
2. CONTROLLING DIMENSION: INCHES
3. DIMENSION Z DEFINES A ZONE WHERE ALL BODY AND LEAD IRREGULARITIES ARE ALLOWED.
4. MAX WIDTH FOR F102 DEVICE = 1.35MM

DIM	INCHES		MILLIMETERS	
	MIN.	MAX.	MIN.	MAX.
A	0.570	0.620	14.48	15.75
B	0.380	0.415	9.66	10.53
C	0.160	0.190	4.07	4.83
D	0.025	0.038	0.64	0.96
F	0.142	0.161	3.60	4.09
G	0.095	0.105	2.42	2.66
H	0.110	0.161	2.80	4.10
J	0.014	0.024	0.36	0.61
K	0.500	0.562	12.70	14.27
L	0.045	0.060	1.15	1.52
N	0.190	0.210	4.83	5.33
Q	0.100	0.120	2.54	3.04
R	0.080	0.110	2.04	2.79
S	0.045	0.055	1.15	1.41
T	0.235	0.255	5.97	6.47
U	0.000	0.050	0.00	1.27
V	0.045	---	1.15	---
Z	---	0.080	---	2.04

STYLE 1:

- PIN 1. BASE
- 2. COLLECTOR
- 3. EMITTER
- 4. COLLECTOR

STYLE 2:

- PIN 1. BASE
- 2. EMITTER
- 3. COLLECTOR
- 4. EMITTER

STYLE 3:

- PIN 1. CATHODE
- 2. ANODE
- 3. GATE
- 4. ANODE

STYLE 4:

- PIN 1. MAIN TERMINAL 1
- 2. MAIN TERMINAL 2
- 3. GATE
- 4. MAIN TERMINAL 2

STYLE 5:

- PIN 1. GATE
- 2. DRAIN
- 3. SOURCE
- 4. DRAIN

STYLE 6:

- PIN 1. ANODE
- 2. CATHODE
- 3. ANODE
- 4. CATHODE

STYLE 7:

- PIN 1. CATHODE
- 2. ANODE
- 3. CATHODE
- 4. ANODE

STYLE 8:

- PIN 1. CATHODE
- 2. ANODE
- 3. EXTERNAL TRIP/DELAY
- 4. ANODE

STYLE 9:

- PIN 1. GATE
- 2. COLLECTOR
- 3. EMITTER
- 4. COLLECTOR

STYLE 10:

- PIN 1. GATE
- 2. SOURCE
- 3. DRAIN
- 4. SOURCE

STYLE 11:

- PIN 1. DRAIN
- 2. SOURCE
- 3. GATE
- 4. SOURCE

STYLE 12:

- PIN 1. MAIN TERMINAL 1
- 2. MAIN TERMINAL 2
- 3. GATE
- 4. NOT CONNECTED

DOCUMENT NUMBER:	98ASB42148B	Electronic versions are uncontrolled except when accessed directly from the Document Repository. Printed versions are uncontrolled except when stamped "CONTROLLED COPY" in red.
DESCRIPTION:	TO-220	PAGE 1 OF 1

ON Semiconductor and are trademarks of Semiconductor Components Industries, LLC dba ON Semiconductor or its subsidiaries in the United States and/or other countries. ON Semiconductor reserves the right to make changes without further notice to any products herein. ON Semiconductor makes no warranty, representation or guarantee regarding the suitability of its products for any particular purpose, nor does ON Semiconductor assume any liability arising out of the application or use of any product or circuit, and specifically disclaims any and all liability, including without limitation special, consequential or incidental damages. ON Semiconductor does not convey any license under its patent rights nor the rights of others.

onsemi, **Onsemi**, and other names, marks, and brands are registered and/or common law trademarks of Semiconductor Components Industries, LLC dba "**onsemi**" or its affiliates and/or subsidiaries in the United States and/or other countries. **onsemi** owns the rights to a number of patents, trademarks, copyrights, trade secrets, and other intellectual property. A listing of **onsemi**'s product/patent coverage may be accessed at www.onsemi.com/site/pdf/Patent-Marking.pdf. **onsemi** reserves the right to make changes at any time to any products or information herein, without notice. The information herein is provided "as-is" and **onsemi** makes no warranty, representation or guarantee regarding the accuracy of the information, product features, availability, functionality, or suitability of its products for any particular purpose, nor does **onsemi** assume any liability arising out of the application or use of any product or circuit, and specifically disclaims any and all liability, including without limitation special, consequential or incidental damages. Buyer is responsible for its products and applications using **onsemi** products, including compliance with all laws, regulations and safety requirements or standards, regardless of any support or applications information provided by **onsemi**. "Typical" parameters which may be provided in **onsemi** data sheets and/or specifications can and do vary in different applications and actual performance may vary over time. All operating parameters, including "Typicals" must be validated for each customer application by customer's technical experts. **onsemi** does not convey any license under any of its intellectual property rights nor the rights of others. **onsemi** products are not designed, intended, or authorized for use as a critical component in life support systems or any FDA Class 3 medical devices or medical devices with a same or similar classification in a foreign jurisdiction or any devices intended for implantation in the human body. Should Buyer purchase or use **onsemi** products for any such unintended or unauthorized application, Buyer shall indemnify and hold **onsemi** and its officers, employees, subsidiaries, affiliates, and distributors harmless against all claims, costs, damages, and expenses, and reasonable attorney fees arising out of, directly or indirectly, any claim of personal injury or death associated with such unintended or unauthorized use, even if such claim alleges that **onsemi** was negligent regarding the design or manufacture of the part. **onsemi** is an Equal Opportunity/Affirmative Action Employer. This literature is subject to all applicable copyright laws and is not for resale in any manner.

PUBLICATION ORDERING INFORMATION

LITERATURE FULFILLMENT:

Email Requests to: orderlit@onsemi.com

onsemi Website: www.onsemi.com

TECHNICAL SUPPORT

North American Technical Support:

Voice Mail: 1 800-282-9855 Toll Free USA/Canada

Phone: 011 421 33 790 2910

Europe, Middle East and Africa Technical Support:

Phone: 00421 33 790 2910

For additional information, please contact your local Sales Representative