

3-PHASEN-EINSPEISEKLEMME FUER SCHUETZ
3RT201., BGR S00

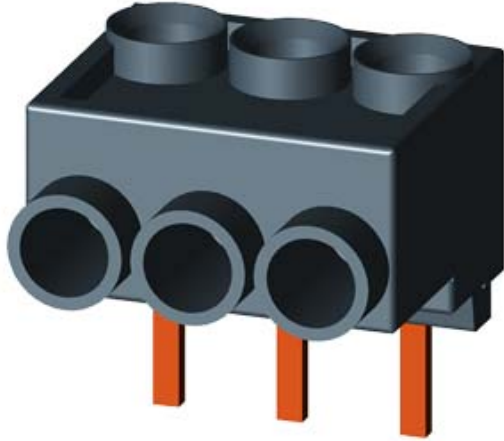

Allgemeine technische Daten:

Produkt-Markename		SIRIUS
Produkt-Bezeichnung		3-Phasen-Einspeiseklemme
Baugröße des Schützes		S00
Schutzart IP frontseitig		IP20
Umgebungstemperatur		
• während Lagerung	°C	-50 ... +80
• während Betrieb	°C	-40 ... +60
Isolationsspannung bei Verschmutzungsgrad 3 Bemessungswert	V	690

Einbau/ Befestigung/ Abmessungen:





Breite	mm	25,9
Höhe	mm	30,4
Tiefe	mm	28,4

Anschlüsse/ Klemmen:

Ausführung des elektrischen Anschlusses		
• für Hauptstromkreis		Schraubanschluss mit Rahmenklemme

Approbationen/ Zertifikate:

Eignungsnachweis		CE / UL / CSA / CCC
------------------	--	---------------------

allgemeine Produktzulassung			Konformitätserklärung	Prüfbescheinigungen	Schiffbau
 CSA	 UL		 EG-Konf.	spezielle Prüfbescheinigungen <u>n</u>	 ABS

Schiffbau					
 BUREAU VERITAS	 DNV	 GL	 LRS	 PRS	 RINA

Schiffbau	sonstiges		
 RMRS	Konformitätserklärung <u>ng</u>	Umweltbestätigung	sonstig

Weitere Informationen

Information- and Downloadcenter (Kataloge, Broschüren,...)

<http://www.siemens.de/industrial-controls/catalogs>

Industry Mall (Online-Bestellsystem)

<http://www.siemens.com/industrymall>

CAX-Online-Generator

<http://support.automation.siemens.com/WW/CAXorder/default.aspx?lang=de&mlfb=3RA29133K>

Service&Support (Handbücher, Betriebsanleitungen, Zertifikate, Kennlinien, FAQs,...)

<http://support.automation.siemens.com/WW/view/de/3RA29133K/all>

Bilddatenbank (Produktfotos, 2D-Maßzeichnungen, 3D-Modelle, Geräteschaltpläne, EPLAN Makros, ...)

<http://www.automation.siemens.com/bilddb/index.aspx?attID9=3RA29133K&lang=de>

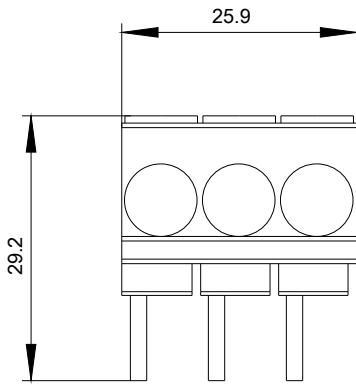

letzte Änderung:

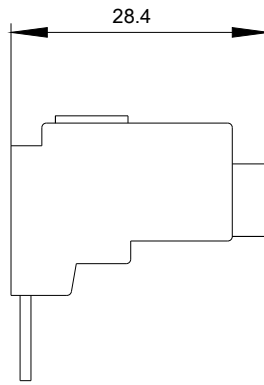

09.03.2015