

Cylindrical Handles • rotating
24530.0010

Product Description

Material



Axle part

- Steel, zinc-plated by galvanization

Cylindrical handle

- Thermosetting plastic PF 31, black

Drawing

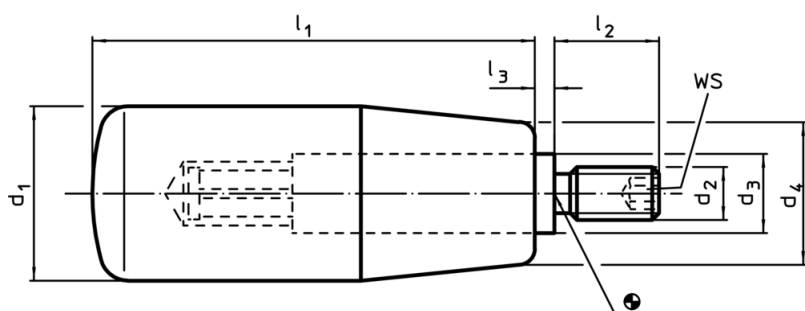

Order information

Dimensions							WS	🌡️ max. [°C]	📦 [g]	Art. No.
d ₁	d ₂	d ₃	d ₄ [mm]	l ₁	l ₂	l ₃	[mm]			
Thermoset, steel										
18	M6	10	15	40	12	2.5	3	110	29	24530.0010

Application example

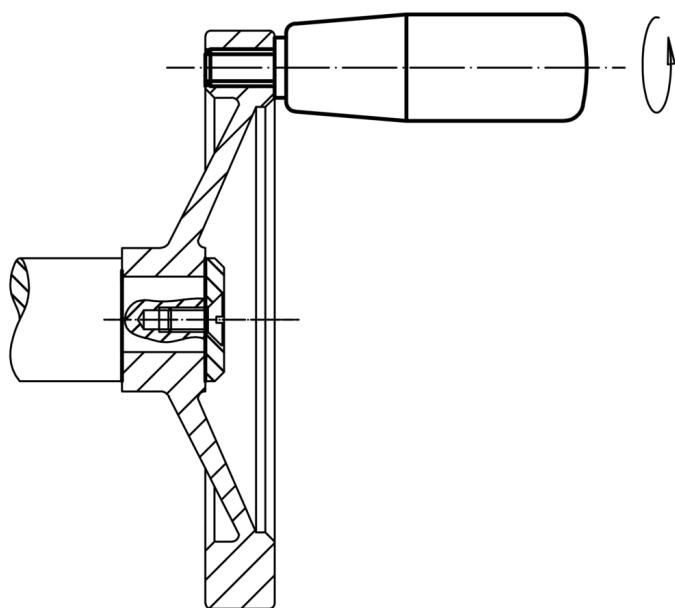

Compliance

RoHS compliant

Contains lead - compliant according to exceptions 6a / 6b / 6c

Contains SVHC substances >0,1% w/w

Contains lead - SVHC list [REACH] as of 10.06.2022

Contains Proposition 65 substances



Lead can cause cancer and reproductive harm from exposure
<https://www.P65Warnings.ca.gov/>

Free from Conflict Minerals

This product does not contain any substances designated as "conflict minerals" such as tantalum, tin, gold or tungsten from the Democratic Republic of Congo or adjacent countries.