

Rotary Cam Switch CS20A

Rotary Cam Switch with central fixing 22.5mm for panel mounting

- Range of rotary cam switches with a choice of 4 operators
- Key operators permit key removal in all latched positions
- Finger proof screw terminals to IP20 protection
- UL/CSA
- Designed to IEC 60947-3
- Single hole, front panel mounting
- Switch body supplied with legend plate for use with square escutcheon frame actuator

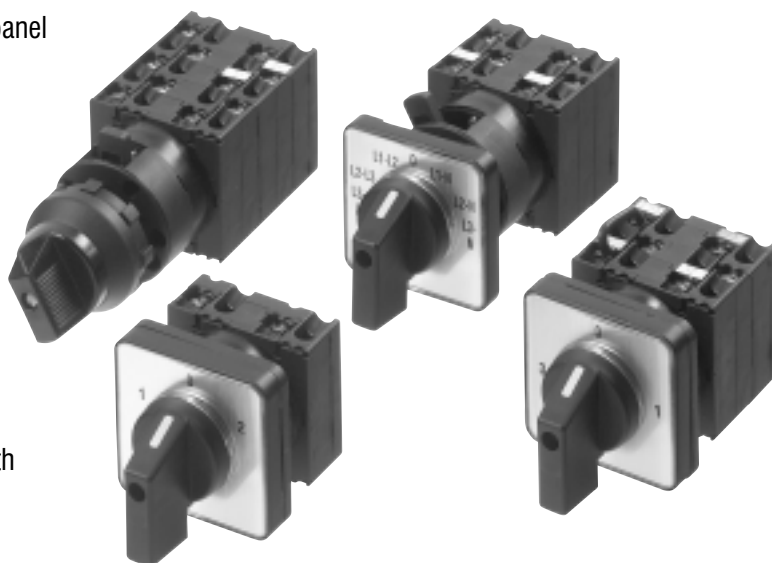

Options and ordering matrix

Handle operators

RB2 Round bezel



SP2 Square escutcheon



Key operators

RBK2 Round bezel



SPK2 Square escutcheon



Specification

Rated thermal current I _{th}	A	20
Rated operational voltage U _e IEC/VDE/BS	V	690
Utilisation category AC21A, AC21B		
Rated operational current I _e	A	20
Utilisation category AC23B @ 400V	A	16
Utilisation category AC15	220/240V 380/440V	6A 4A
Cable cross section	mm ²	0.75-2.5
Contact material		Silver alloy
Mounting hole diameter		22.5mm
Maximum backup fuse (gl)		20A
Protection class from rear		IP20

Accessories

Spare key	B4-R455
Tightening wrench	J7049

Rotary Cam Switch CS20A continued



Options and ordering matrix continued

Off-On switch

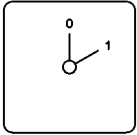

Description	Cells	Part Ref
1 Pole	1	CS20A-A1
2 Pole	1	CS20A-A2
3 Pole	2	CS20A-A3
4 Pole	2	CS20A-A4
6 Pole	3	CS20A-A6
8 Pole	3	CS20A-A8

Connection diameter

For 1-4 poles

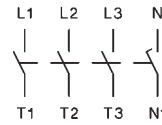

For 6-8 poles

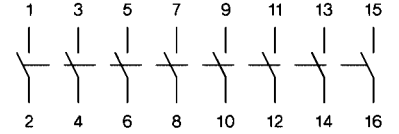

Change over switches, with off

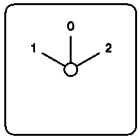

Description	Cells	Part Ref
1 Pole	1	CS20A-U1
2 Pole	2	CS20A-U2
3 Pole	3	CS20A-U3
4 Pole	4	CS20A-U4
6 Pole	6	CS20A-U6
8 Pole	8	CS20A-U8

Connection diameter

For 1-4 poles

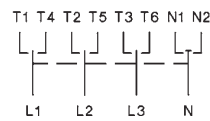

For 6-8 poles

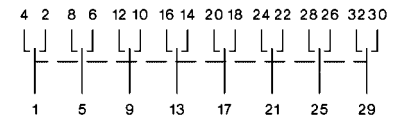

Change over switches, without off

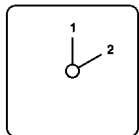

Description	Cells	Part Ref
1 Pole	1	CS20A-W1
2 Pole	2	CS20A-W2
3 Pole	3	CS20A-W3
4 Pole	4	CS20A-W4
6 Pole	6	CS20A-W6
8 Pole	8	CS20A-W8

Connection diameter

For 1-4 poles

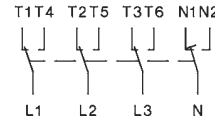

For 6-8 poles

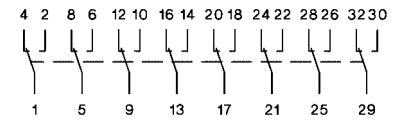

3 position step switches, without off

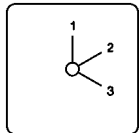

Description	Cells	Part Ref
1 Pole	2	CS20A-ST31
2 Pole	3	CS20A-ST32
3 Pole	5	CS20A-ST33

Connection diameter

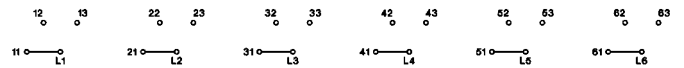

4 position step switches, without off

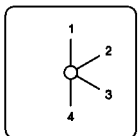

Description	Cells	Part Ref
1 Pole	2	CS20A-ST41
2 Pole	4	CS20A-ST42
3 Pole	6	CS20A-ST43

Connection diameter

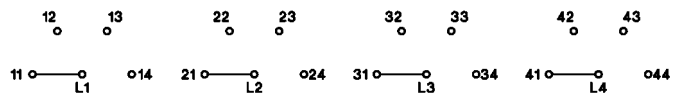

5 position step switches, without off

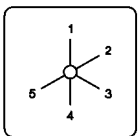

Description	Cells	Part Ref
1 Pole	3	CS20A-ST51
2 Pole	5	CS20A-ST52
3 Pole	8	CS20A-ST53

Connection diameter

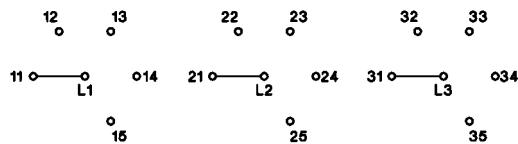

6 position step switches, without off

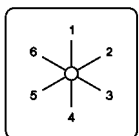

Description	Cells	Part Ref
1 Pole	3	CS20A-ST61
2 Pole	6	CS20A-ST62
3 Pole	9	CS20A-ST63

Connection diameter

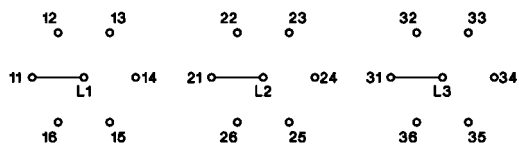

Options and ordering matrix continued

Change over switch with spring return to off

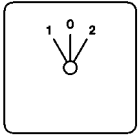

Description	Cells	Part Ref
1 Pole	1	CS20A-UR1
2 Pole	2	CS20A-UR2
3 Pole	3	CS20A-UR3

Connection diameter

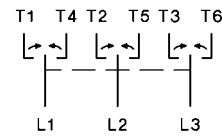

3 phase motor reversing switch

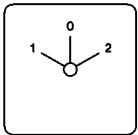

Description	Cells	Part Ref
5.5kW @ 380/440	3	CS20A-WU3

Connection diameter

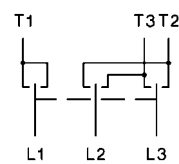

3 current transformers

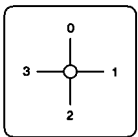

Description	Cells	Part Ref
1 Pole	3	CS20A-M31

Connection diameter

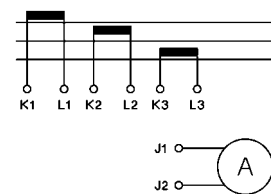
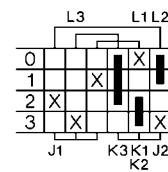

Dimensions

Central fixing 22.5mm
CS20A

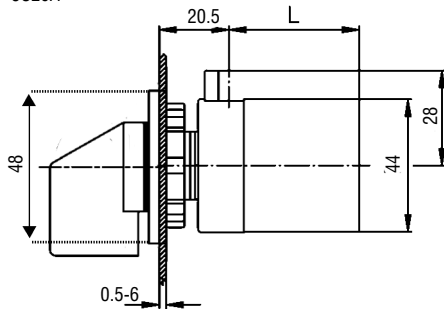

For further dimensions see table below

Dimension L with .. cells

Type	1	2	3	4	5	6	7	8
CS20A	36,5	46	55,5	65	74,5	84	93,5	103

Mounting hole

