

high-feed milling cutter M370™

for indexable milling inserts WOEJ 0804.., WOEJ 1207..

WIDIA 

Application:

the M370 is designed for high feed rates and high productivity, combining the latest indexable inserts technology with outstanding performance and reliability. the version with double-sided indexable inserts with 6 cutting edges each provides safety, an optimum cutting volume and lower costs per cutting edge.

Execution:

- extremely high cutting volume
- six cutting edges per indexable insert through double-sided design
- milling cutter body with high stability
- ideal for rough machining with high feed rates
- with internal cooling

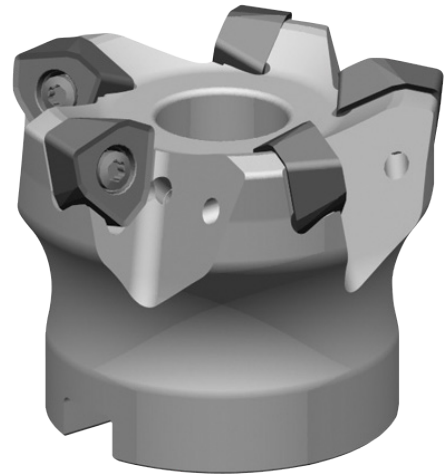

Art. no.	16042 104
Brand	WIDIA
Manufacturer Part Number	53389 15
Max. cutting edge diameter	63 mm
Min. cutting edge diameter	46.09 mm
Length	50 mm
Bore diameter	22 mm
max. ap	2 mm
Number of cutting edges	4 PCS
Gross Weight	0.570 kg
Product Group	1XJ

EAN

4050839378494