

Handwheels • DIN 950 light metal

24590.0200

Product Description

Hub machined; rim turned and mirror-finished on all sides, non-machined surfaces cleanly blasted.

Material

Handwheel

- Light metal Al

Machine handle DIN 98 EH 24460. rotating

- Steel, turned, zinc-plated by galvanization, passivated

Assembly

Shaft-end washers EH 22270. for axial fastening.

More information

Further products

- Shaft-End Washers
- Rotating Machine Handles, DIN 98



Drawing

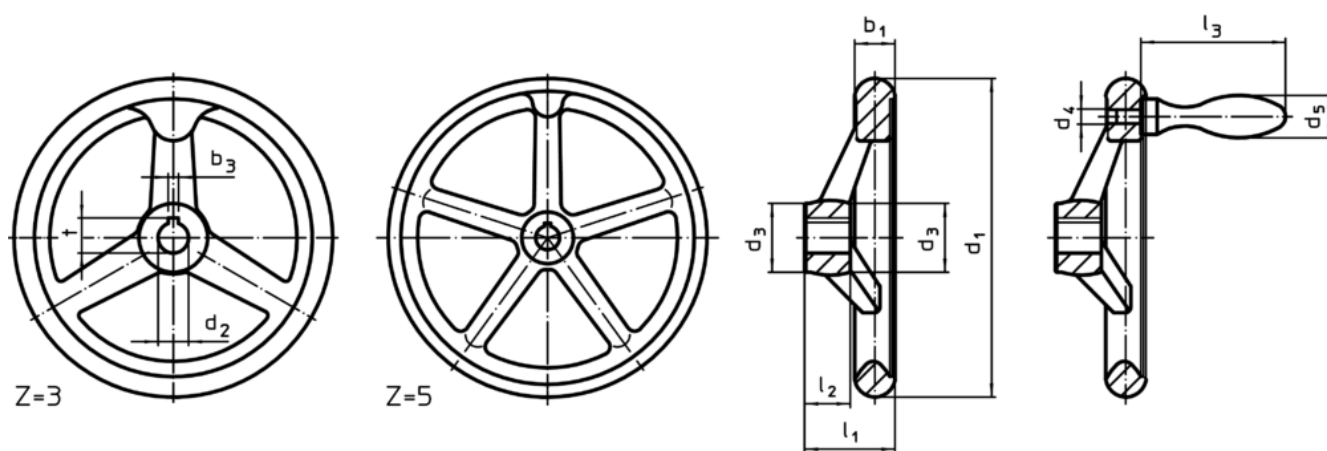

picture 1

picture 2

The orientation of the hub keyway may be different than shown in the drawing.

Order information

Dimensions								Number of spokes z	Corresponding machine handle DIN 39 / DIN 98	 [g]	Art. No.
d ₁	d ₂ H7	d ₃	d ₄	d ₅	l ₁ ~	l ₂	l ₃				
without keyway, with rotating handle EH 24460., assembled form B-F/G (formerly D 4) – picture 2											
80	10	24	M6	16	29	16	49	3	16	150	24590.0200

Application example



Compliance

RoHS compliant

Contains lead - compliant according to exceptions 6a / 6b / 6c

Contains SVHC substances >0,1% w/w

Contains lead - SVHC list [REACH] as of 10.06.2022

Contains Proposition 65 substances



Lead can cause cancer and reproductive harm from exposure
<https://www.P65Warnings.ca.gov/>

Free from Conflict Minerals

This product does not contain any substances designated as "conflict minerals" such as tantalum, tin, gold or tungsten from the Democratic Republic of Congo or adjacent countries.