

## Face milling cutters, 45°

For SEET 12T3... indexable milling inserts

**ORION**<sup>®</sup>

### Application:

For universal use in all materials, predestined for cast processing.

### Execution:

- Nickel-plated supports
- Long-term tested support design
- Normal and fine pitch
- Clamping screw tightening torque (indexable insert) M3.5 = 3.9 Nm

### Advantage:

- Highly positive indexable milling inserts for low-vibration, steady cutting
- Outstanding value for money

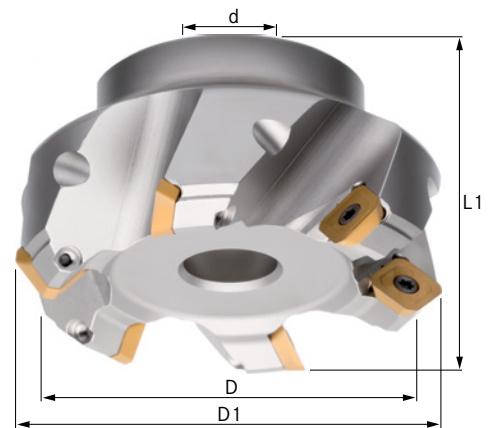

<b>Art. no.</b>	<b>16003 206</b>
<b>Brand</b>	ORION
<b>Manufacturer Part Number</b>	16003206
<b>Min. cutting edge diameter</b>	63 mm
<b>Max. cutting edge diameter</b>	74 mm
<b>Length</b>	40 mm
<b>Bore diameter</b>	22 mm
<b>max. ap</b>	6 mm
<b>Number of cutting edges</b>	5 PCS
<b>Gross Weight</b>	0.809 kg
<b>Product Group</b>	148

### EAN

4039247573189