

Infrared thermometers

Infrared video thermometers

Infrared cameras

Portable thermometers

PRODUCT OVERVIEW

Non-contact temperature measurement

Made in Germany

innovative infrared technology

The adequate measurement device

Spot measurement or thermal image?



A **point measuring infrared thermometer** should be used if you know where the critical point or the area to be measured is positioned within your application. The size of the measuring object is important to define which lens is necessary. It is therefore possible to monitor the accurate temperature and optimize processes – if necessary – before quality problems arise.

Pyrometer configurator:

www.optris.global/pyrometer-configurator

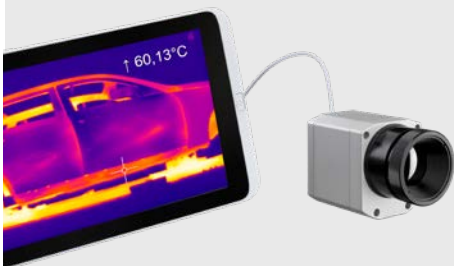

Infrared cameras should be used in cases where more than one critical area exists or the area cannot be clearly defined. Critical areas can be localized by the camera through the demonstration of thermal images. The areas can then be permanently monitored by one or multiple fixed infrared thermometers.

First of all, it is important to define the measurement task and to decide on one of these two measures:

Which object surface?

The condition of the object surface defines the measurement device and wavelength to be used for the application. The **emissivity ϵ** occupies a central position. The choice of the right device is of great importance especially for metals, where the emissivity depends on the temperature and wave length.

We are able to offer appropriate measurement devices for most applications throughout a wide product range.

The following explanation helps to find the right **wavelength** for your application:

- 8 – 14 μm for non-metal surfaces (Type of device: LT)
- 0.5; 1.0; 1.6; 2.3 μm mainly for liquid metals and metal surfaces (Type of device: 05M; 1M; 2M; 3M)
- 3.43 μm for thin plastic films like PE, PP and PS (Type of device: P3)
- 3.9; 4.24; 4.64; 7.9 μm for special applications (Type of device: MT; F2; F6)
- 5.0 μm for glass surfaces (Type of device: G5)
- 7.9 μm for plastic foils and glass surfaces (Type of device: P7/G7)

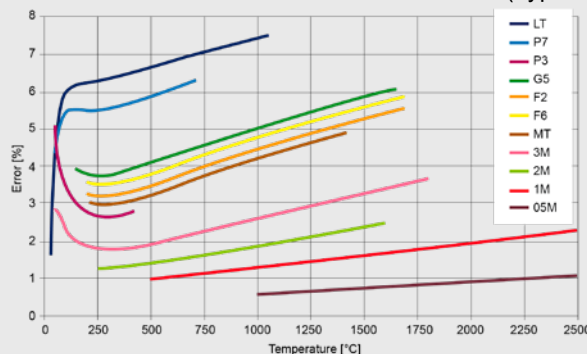

Short wavelengths reduce measurement errors on surfaces with low, unknown or changing emissivity. This occurs mostly with metals. The diagram above shows the measurement errors across different wavelengths if the emissivity is wrongly adjusted by only 10 percent.

Which temperature range?

The temperature is another factor to decide on. The range should cover all relevant temperatures of the

application. The measurement range of the devices is between **-50 °C and 3000 °C**.

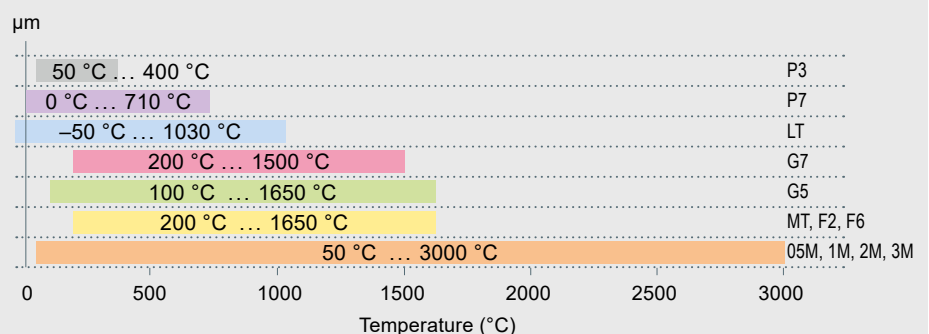

Display of temperature over wavelength for the devices of the compact and the high performance series

Which process velocity?

To achieve accurate temperature measurement it is important to know how fast measuring objects are moving in front of the sensor or how fast they change temperature.

Our fastest infrared thermometer captures changes within **1 ms**.

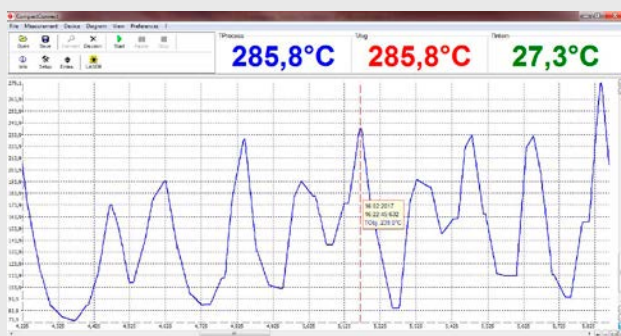

Display of fast temperature changes over a period of time.

Integration of sensors?

Our temperature sensors can be installed as part of the process with **mounting brackets** or **flanges**.

Depending on the device, we offer different analog and digital interfaces for **data evaluation** such as triggering, alerting or saving of data.

Analog Interfaces:

0 – 20 mA, 4 – 20 mA, 0 – 5 V, 0 – 10 V,
Thermocouple (type J, type K)

Digital Interfaces:

USB, RS232, RS485, Relay, Profibus DP, CAN Bus, Ethernet

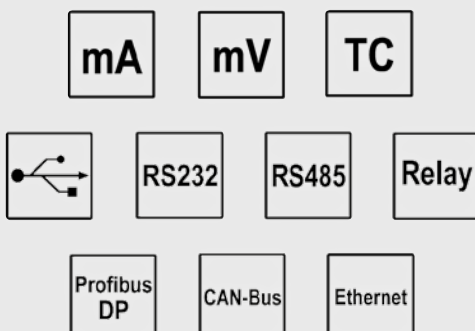

Object size and measurement distance

IR thermometers use the radiation signal emitted by the entire measurement spot. The size of the measurement spot (S) largely depends on the device, the optics selected and the distance between the sensor and measurement object plane (D):

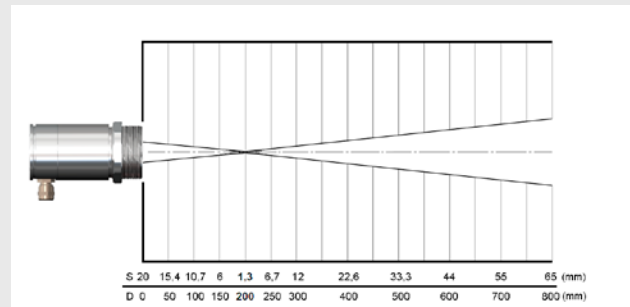

Measurement spot diameter (S) depending on the measurement distance (D) with an IR thermometer

For a precise temperature measurement, the measurement spot needs to be smaller than, or the same size as the object to be measured.

If the measurement spot is larger than the object, a temperature is calculated from the averaged heat radiation signal from the object and its environment. In a colder environment, it means that correspondingly, the temperature measurement value determined is too low.

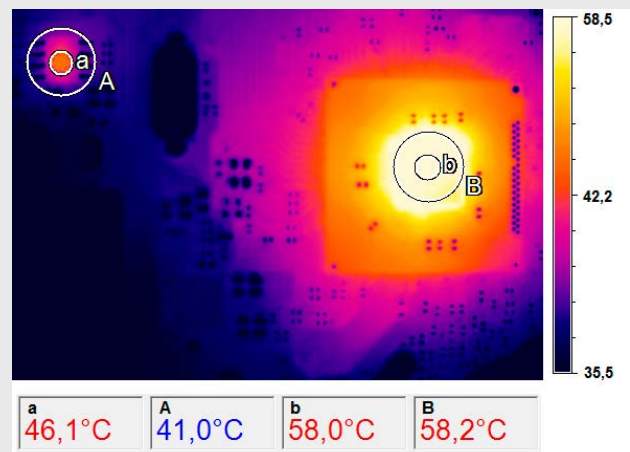

IR image of an electronics circuit board – adaptation of the measurement spot to the object size

When transferred to the two-dimensional measurement with IR cameras, the pixel size there needs to suit the object size for the selected measurement distance. Here, the object should fill at least 3x3 pixels.

In the example above, the correct temperature of a chip of 46 °C is determined with the suitable measurement spot size (a). A measurement spot (A) which is three times larger already leads to a measurement error of 5 °C or 10%. If you select a larger component on the same circuit board (on the right in the picture), then in this case, both measurement spots (b and B) provide the correct temperature measurement value of 58 °C.

Compact series

Small, compact infrared thermometers, ideal for use in cramped and hot surroundings



Base Model	CS	CSmicro	CSmicro	CSmicro	CSmicro
Type	LT	LT02 / LT15 (H) / LT 22 H	LT15 HS	2M	3M
Classification / special features	Single-piece sensor with smart LED display (self diagnostics, aiming support, alarm, temperature code)	Single-piece sensor with electronics in cable; smart LED display	Single-piece two-wire sensor with electronics in cable; high thermal sensitivity; smart LED display	Single-piece sensor for temp. measurements on metal; electronics in cable; smart LED display	Single-piece sensor for temp. measurements on metal; electronics in cable; smart LED display
Detector	Thermopile	Thermopile	Thermopile	InGaAs	Ext. InGaAs
Sensing head exchangeable	-	-	-	-	-
Head cable shortening	■	■ (behind electronics)	■ (behind electronics)	■ (behind electronics)	■ (behind electronics)
Thread (sensing head)	M12x1	M12x1	M18x1	M12x1	M12x1
Spectral range	8–14 μm	8–14 μm	8–14 μm	1.6 μm	2.3 μm
Temperature ranges	-40 °C ... 1030 °C	-50 °C ... 1030 °C	-20 °C ... 150 °C	2ML: 250 °C ... 800 °C 2MH: 385 °C ... 1600 °C	3ML: 50 °C ... 350 °C 3MH: 100 °C ... 600 °C
Temperature resolution	0.1 K	0.1 K	0.025 K [>20 °C]	0.1 K	0.1 K
Optical resolution	15:1	LT02: 2:1 / LT15 (H): 15:1 / LT22 H: 22:1	15:1	2ML: 40:1 2MH: 75:1	3ML: 22:1 3MH: 33:1
Option: CF lens	■	■	■	■	■
Smallest spot (CF optics/add. CF lens)	0.8 mm @ 10 mm	LT02: 2.5 mm @ 23 mm LT15 (H): 0.8 mm @ 10 mm LT 22 H: 0.6 mm @ 10 mm	0.8 mm @ 10 mm	2ML: 2.7 mm @ 110 mm 2MH: 1.5 mm @ 110 mm	3ML: 1.5 mm @ 30 mm 3MH: 1 mm @ 30 mm
Smallest spot (SF optics)	7 mm	7 mm	7 mm	7 mm	7 mm
Sighting	LED aiming	LED aiming	LED aiming	LED aiming	LED aiming
Response time (90 %)	25 ms	14 ms	150 ms	8 ms (mA version: 20 ms)	8 ms (mA version: 20 ms)
Accuracy	± 1.5 °C or ± 1.5 %	± 1 °C or ± 1 %	± 1 °C or ± 1 %	$\pm (0.3\% T_{Meas} + 2$ °C)	$\pm (0.3\% T_{Meas} + 2$ °C)
Outputs analog: 0–20 mA / 4–20 mA / 0–5 V / 0–10 V / t/c (K/J)	- / - / ■ / ■ / ■	- / - / ■ / ■ / - or - / ■ / - / - / -	- / - / ■ / ■ / - or - / ■ / - / - / -	- / - / ■ / ■ / - or - / ■ / - / - / -	- / - / ■ / ■ / - or - / ■ / - / - / -
Second analog output	-	-	-	-	-
Interfaces: USB / RS232 / RS485 / Profibus / Ethernet	■ / - / - / - / -	■ / - / - / - / -	■ / - / - / - / -	■ / - / - / - / -	■ / - / - / - / -
Signal processing: Peak / Valley / AVG / Advanced hold	■ / ■ / ■ / ■	■ / ■ / ■ / ■	■ / ■ / ■ / ■	■ / ■ / ■ / ■	■ / ■ / ■ / ■
T _{Amb} Head min.	-20 °C	-20 °C	-20 °C	-20 °C	-20 °C
T _{Amb} Head max.	80 °C	LT02 / LT15: 120 °C LT15 H / LT22 H: 180 °C	75 °C	125 °C	85 °C
T _{Amb} Electronics max.	80 °C	80 °C / 75 °C (mA version)	80 °C / 75 °C (mA version)	80 °C / 75 °C (mA version)	80 °C / 75 °C (mA version)
Functional inputs/ number	■ / 1	■ / 1	■ / 1	■ / 1	■ / 1
External emissivity adjustment	■ (via V _{cc} adjust)	■ (mV version)	■ (mV version)	■ (mV version)	■ (mV version)
External background temperature control	■	■ (mV version)	■ (mV version)	■ (mV version)	■ (mV version)
Trigger input for reset of hold functions	■	■	■	■	■
Digital I/O pins/ number	-	-	-	-	-
Simultaneous analog and digital output	-	■ (mA version only)	■ (mA version only)	■ (mA version only)	■ (mA version only)
Alarm output as an alternative to analog output	■	■	■	■	■
Additional alarm output/ switching output	■	■	■	■	■
Voltage supply	5–30 V DC	5–30 V DC	5–30 V DC	5–30 V DC	5–30 V DC
Standard cable length	1 m	0.5 m + 0.5 m	0.5 m + 0.5 m	0.5 m + 0.5 m	0.5 m + 0.5 m
Cable length options	3 / 8 / 15 m	Options up to 9 m	Options up to 9 m	Options up to 9 m	Options up to 9 m

Spot size calculator:
www.optris.global/spot-size-fov-calculators



CT	CTfast	CThot	CT	CT	CT	CT
LT02 / LT15 / LT22	LT15F / LT25F	LT02H / LT10H	1M / 2M	3M	G5	P3 / P7
Two-piece sensor with separate electronic box incl. programming keys and display	Two-piece sensor with fast response time and separate electronic box incl. programming keys and display	Two-piece sensor for hot surroundings with separate electronic box incl. programming keys and display	Two-piece sensor for high temp. meas. of metal with separate electronic box incl. progr. keys and display	Two-piece sensor for low temp. meas. of metal with separate electronic box incl. progr. keys and display	Two-piece sensor for temp. meas. of glass with separate electronic box incl. progr. keys and display	Two-piece sensor for temp. meas. on thin plastic film and glass (P7) with separate electronic box incl. progr. keys and display
Thermopile	Thermopile	Thermopile	1M: Si / 2M: InGaAs	Extended InGaAs	Thermopile	Thermopile (P7)
■	-	■	■	■	■	-
■ [-0.1 K/m]	■ [max. 3 m]	■ [-0.1 K/m]	■ [max. 3 m]	■	■ [-0.1 K/m]	-
M12x1	M12x1	M18x1	M12x1	M12x1	M12x1	M18x1
8-14 µm	8-14 µm	8-14 µm	1M: 1.0 µm / 2M: 1.6 µm	2.3 µm	5.0 µm	P3: 3.43 µm / P7: 7.9 µm
LT02: -50 °C ... 600 °C LT15: -50 °C ... 600 °C LT22: -50 °C ... 975 °C	-50 °C ... 975 °C	-40 °C ... 975 °C	1ML: 485 °C ... 1050 °C 1MH: 650 °C ... 1800 °C 1MH1: 800 °C ... 2200 °C 2ML: 250 °C ... 800 °C 2MH: 385 °C ... 1600 °C 2MH1: 490 °C ... 2000 °C	L: 50 °C ... 400 °C H: 100 °C ... 600 °C H1: 150 °C ... 1000 °C H2: 200 °C ... 1500 °C H3: 250 °C ... 1800 °C	L: 100 °C ... 1200 °C H: 250 °C ... 1650 °C	P3: 50 °C ... 400 °C P7: 0 °C ... 710 °C
0.1 K	LT15F: 0.2 K LT25F: 0.4 K	0.25 K	0.1 K	0.1 K	L: 0.1 K H: 0.2 K	P3: 0.1 K / P7: 0.5 K
LT02: 2:1 / LT15: 15:1 / LT22: 22:1	LT15F: 15:1 LT25F: 25:1	LT02H: 2:1 LT10H: 10:1	L: 40:1 H: 75:1	L: 22:1 / H: 33:1 / H1-H3: 75:1	L: 10:1 H: 20:1	P3: 15:1 P7: 10:1
■	■	■	■	■	-	-
LT02: 2.5 mm @ 23 mm LT15: 0.8 mm @ 10 mm LT22: 0.6 mm @ 10 mm	0.5 mm @ 10 mm	LT02H: 2.5 mm @ 23 mm LT10H: 1.2 mm @ 10 mm	1.5 mm @ 110 mm	3.4 mm @ 110 mm	-	P7: 1.2 mm @ 10 mm
7 mm	7 mm	7 mm	7 mm	7 mm	7 mm	7 mm
-	-	-	-	-	-	-
150 ms	LT15F: 9 ms / LT25F: 6 ms	100 ms	1 ms	1 ms	L: 120 ms / H: 80 ms	P3: 100 ms / P7: 150 ms
±1 °C or ±1 %	±2 °C or ±1 %	±1.5 °C or ±1 %	±(0.3% T _{meas} + 2 °C)	±(0.3% T _{meas} + 2 °C)	±2 °C or ±1 %	P3: ±3 °C or 1 % P7: ±1.5 °C or 1 %
■ / ■ / ■ / ■ / ■	■ / ■ / ■ / ■ / ■	■ / ■ / ■ / ■ / ■	■ / ■ / ■ / ■ / ■	■ / ■ / ■ / ■ / ■	■ / ■ / ■ / ■ / ■	■ / ■ / ■ / ■ / ■
■	■	■	-	-	■	■
■ / ■ / ■ / ■ / ■	■ / ■ / ■ / ■ / ■	■ / ■ / ■ / ■ / ■	■ / ■ / ■ / ■ / ■	■ / ■ / ■ / ■ / ■	■ / ■ / ■ / ■ / ■	■ / ■ / ■ / ■ / ■
■ / ■ / ■ / ■	■ / ■ / ■ / ■	■ / ■ / ■ / ■	■ / ■ / ■ / ■	■ / ■ / ■ / ■	■ / ■ / ■ / ■	■ / ■ / ■ / ■
-20 °C	-20 °C	-20 °C	-20 °C	-20 °C	-20 °C	P3: 0 °C / P7: -20 °C
LT02: 130 °C LT15/LT22: 180 °C	120 °C	250 °C	1M: 100 °C 2M: 125 °C	85 °C	85 °C	P3: 75 °C / P7: 85 °C
85 °C	85 °C	85 °C	85 °C	85 °C	85 °C	P3: 75 °C / P7: 85 °C
■ / 3	■ / 3	■ / 3	■ / 3	■ / 3	■ / 3	■ / 3
■	■	■	■	■	■	■
■	■	■	■	■	■	■
■	■	■	■	■	■	■
-	-	-	-	-	-	-
■	■	■	■	■	■	■
■	■	■	■	■	■	■
■	■	■	■	■	■	■
8-36 V DC	8-36 V DC	8-36 V DC	8-36 V DC	8-36 V DC	8-36 V DC	8-36 V DC
1 m	1 m	3 m	3 m	3 m	3 m	3 m
3 / 8 / 15 m	3 / 8 / 15 m	8 / 15 m	8 / 15 m	-	8 / 15 m	P3: 8 m / P7: 8 m, 15 m

Accessories Compact series

Mechanical accessories

			
<p>ACCTFB / ACCTFBMH / ACCTFB2 Mounting bracket, adjustable in one axis (M12x1 sensing head, massive housing, mounting of CT sensing head + Laser-Sightingtool)</p>	<p>ACCTMB Mounting bolt with thread M12x1</p>	<p>ACCTMG Mounting fork, adjustable in 2 axes, with thread M12x1</p>	<p>ACCTKF40B270 / ACCTKF40GE KF40 flange for CT1M, 2M, 3M with B270 window (up to 10⁻⁷ mbar) / KF40 flange for CTLT with Ge window (up to 10⁻⁷ mbar)</p>
			
<p>ACCTTAS Tilt assembly for heads with optical resolution ≥10:1</p>	<p>ACCTRAIL Rail mount adapter for CT electronics</p>	<p>ACCTCOV Closed cover for CT electronic box</p>	<p>ACCTTAM25 Thread adapter M12x1 to M25x1.5 incl. 2 mounting nuts</p>

Optical accessories

		
<p>ACCTCF / ACCTPW CF-lens or protective window (for LT) for M12x1 sensing head ACCTCFHT / ACCTPWHT for 1M, 2M, 3M</p>	<p>ACCTCFE / ACCTPWE CF-lens or protective window (for LT) with external thread for air purge or massive housing ACCTCFHTE / ACCTPWHT for 1M, 2M, 3M</p>	<p>D08ACCTLST / ACCTOEMLST Laser-Sightingtool (for CT) / OEM Laser-Sightingtool, 635 nm, rotation symmetrical, for connection to CT electronics, power supply via CT electronic box or battery</p>
		
<p>ACCTRAM Right angle mirror for measurements 90° to the sensor axis for sensing heads with optical resolution ≥10:1</p>	<p>ACCTPA + ACCTST20 20 (20 mm length) / ACCTST40 (40 mm length) / ACCTST88 (88 mm length) Pipe adapter with M12x1 internal thread + Sighting tube with M12x1 external thread</p>	

Air purges and protective housings



<p>ACCSAP Air purge collar (for heads with optical resolution $\geq 10:1$)</p>	<p>ACCTAPMH Air purge collar for Massive housing (D06) / CSmicro HS/ CTho/ CT P3/ CT P7</p>	<p>Massive housing of:</p> <ul style="list-style-type: none"> • compact, brass (D06ACCTMHB) • anodized aluminium (D06ACCTMHA) • stainless steel (D06ACCTMHS) <ul style="list-style-type: none"> • stainless steel version with CF optics (D06ACCTMHSCF) • stainless steel version for HT CF optics (D06ACCTMHSCFHT)
--	--	--



<p>ACCTAPLCF Air purge collar, laminar, with integrated CF-lens (for LT)</p>	<p>ACCTAPLCFHT Air purge collar, laminar, with integrated CF-lens (for 1M/ 2M/ 3M)</p>	<p>ACCTAPL Air purge collar, laminar</p>	<p>ACCTAP / ACCTAP2 Air purge for CT heads (not for heads with 32 mm length)</p>
---	---	---	---

Combinations



<p>ACCTAPL Air purge collar, laminar</p>	<p>ACCTMG Mounting fork</p>	<p>Device adjustable in two axes</p>	<p>ACCTFB2 Mounting bracket for sensing head + Sighting tool</p>	<p>D08ACCTLST / ACCTOEMST OEM Laser-Sightingtool</p>	<p>Sensing head with Laser-Sighting tool</p>
---	--	--------------------------------------	---	---	--



<p>ACCTFB Mounting bracket for M12x1 sensing head</p>	<p>ACCTMB Mounting bolt</p>	<p>ACCTAB Device adjustable in two axes</p>	<p>D06ACCTAPMH Massive housing, stainless steel</p>	<p>ACCTAPMH Airpurge, stainless steel</p>	<p>Massive housing with air purge</p>
--	--	--	--	--	---------------------------------------

High performance series

Infrared thermometers with highest optical resolution and double laser



Base Model	CSlaser	CSlaser	CSlaser	CTlaser	CTlaser
Type	LT / hs LT	2M	G5HF	LT / LTF	05M
Classification / special features	Single-piece two-wire sensor with electronics in sensing head	Single-piece two-wire sensor with electronics in sensing head for measurement of metal	Single-piece two-wire infrared thermometer for temperature measurement of glass	Two-piece sensor with separate electronic box with fast response time, incl. programming keys and display	Two-piece sensor with separate electronic box for high temp. measurement of liquid metal, incl. programming keys and display
Detector	Thermopile	InGaAs	Thermopile	Thermopile	Si
Sensing head exchangeable	–	–	–	■	■
Head cable shortening	■	■	■	■ [max. 6 m]	■ [max. 6 m]
Thread (sensing head)	M48x1.5	M48x1.5	M48x1.5	M48x1.5	M48x1.5
Spectral range	8–14 µm	1.6 µm	5.0 µm	8–14 µm	0.525 µm
Temperature ranges	LT: –30 °C ... 1000 °C hs LT: –20 °C ... 150 °C	L: 250 °C ... 800 °C H: 385 °C ... 1600 °C	200 °C ... 1650 °C	–50 °C ... 975 °C	1000 °C ... 2000 °C
Temperature resolution	LT: 0.1 K / hs LT: 0.025 K	0.1 K	0.1 K	LT: 0.1 K / LTF: 0.5 K	0.2 K
Optical resolution	50:1	2MH: 300:1 2ML: 150:01	45:1	LT: 75:1 LTF: 50:1	150:1
Option: CF lens	–	–	–	–	–
Smallest spot (CF optics/ add. CF lens)	1.4 mm @ 70 mm	0.5 mm @ 150 mm	1.6 mm @ 70 mm	LT: 0.9 mm @ 70 mm LTF: 1.4 mm @ 70 mm	–
Smallest spot (SF optics)	24 mm @ 1200 mm	3.7 mm @ 1100 mm	27 mm @ 1200 mm	LT: 16 mm @ 1200 mm LTF: 24 mm @ 1200 mm	7.3 mm @ 1100 mm
Sighting	Double laser	Double laser	Double laser	Double laser	Double laser
Response time (90 %)	150 ms	10 ms	30 ms	LT: 120 ms / LTF: 9 ms	1 ms
Accuracy	±1 °C or ±1 %	±(0.3 % T _{meas} +2 °C)	±1% or ±1°C	LT: ±1 °C or ±1 % LTF: ±1.5 °C or ±1.5 %	±(0.3 % T _{meas} +2 °C)
Outputs analog: 0–20 mA / 4–20 mA / 0–5 V / 0–10 V / t/c (K/J)	– / ■ / – / – / –	– / ■ / – / – / –	– / ■ / – / – / –	■ / ■ / ■ / ■ / ■	■ / ■ / ■ / ■ / ■
Second analog output	–	–	–	■	–
Interfaces: USB / RS232 / RS485 / Profibus / Ethernet	■ / – / – / – / –	■ / – / – / – / –	■ / – / – / – / –	■ / ■ / ■ / ■ / ■	■ / ■ / ■ / ■ / ■
Signal processing: Peak / Valley / AVG / Advanced hold	■ / ■ / ■ / ■	■ / ■ / ■ / ■	■ / ■ / ■ / ■	■ / ■ / ■ / ■	■ / ■ / ■ / ■
T _{Amb} Head min.	–20 °C	–20 °C	–20 °C	–20 °C	–20 °C
T _{Amb} Head max.	85 °C	85 °C	85 °C	85 °C	85 °C
T _{Amb} Electronics max.	85 °C	85 °C	85 °C	85 °C	85 °C
Functional inputs/ number	– / –	– / –	– / –	■ / 3	■ / 3
External emissivity adjustment	–	–	–	■	■
External background temperature control	–	–	–	■	■
Trigger input for reset of hold functions	–	–	–	■	■
Digital I/O pins/ number	–	–	–	–	–
Simultaneous analog and digital output	■	■	■	■	■
Alarm output as alternative to analog output	■	■	■	■	■
Additional alarm output/ switching output	■	■	■	■	■
Voltage supply	5–30 V DC	5–30 V DC	5–30 V DC	8–36 V DC	8–36 V DC
Standard cable length	3 m	3 m	3 m	3 m	3 m
Cable length options	8 / 15 m	8 / 15 m	3 m / 8 m / 15 m	8 / 15 m	8 / 15 m

Spot size calculator:

<https://www.optris.global/spot-size-fov-calculators>



CTlaser	CTlaser	CT XL	CTlaser	CTlaser	CTlaser	CTratio
1M / 2M	3M	3M	MT / F2 / F6	G5	P7	1M
Two-piece sensor with separate electronic box for high temp. measurement of metal, incl. programming keys and display	Two-piece sensor with separate electronic box for low temp. measurement of metal, incl. programming keys and display	Two-piece sensor with separate electronic box for laser applications, incl. programming keys and display (no laser)	Two-piece sensor with separate electronic box incl. progr. keys and display for measurement: MT: through flames F2: CO ₂ flame gas F6: CO flame gas	Two-piece sensor with separate electronic box for measurement of glass, incl. programming keys and display	Two-piece sensor with separate electronic box for measurement of plastic foils, incl. programming keys and display	Ratio pyrometer with separate electronic box for high temp. measurement of metal feat. glass fiber cable and laser, incl. programming keys and display
1M: Si / 2M: InGaAs	Extended InGaAs	Extended InGaAs	Thermopile	Thermopile	Thermopile	Si sandwich
■	■	–	■	■	■	–
■ [max. 6 m]	■ [max. 6 m]	■	■ [max. 6 m]	■ [max. 6 m]	■ [max. 6 m]	–
M48x1.5	M48x1.5	M30x1	M48x1.5	M48x1.5	M48x1.5	M18x1
1M: 1.0 µm 2M: 1.6 µm	2.3 µm	2.3 µm	MT: 3.9 µm / F2: 4.24 µm / F6: 4.64 µm	5.0 µm	7.9 µm	0.7 – 1.1 µm
1ML: 485 °C ... 1050 °C 1MH: 650 °C ... 1800 °C 1MH1: 800 °C ... 2200 °C 2ML: 250 °C ... 800 °C 2MH: 385 °C ... 1600 °C 2MH1: 490 °C ... 2000 °C	L: 50 °C ... 400 °C H: 100 °C ... 600 °C H1: 150 °C ... 1000 °C H2: 200 °C ... 1500 °C H3: 250 °C ... 1800 °C	H: 100 °C ... 600 °C H1: 150 °C ... 1000 °C H2: 200 °C ... 1500 °C H3: 250 °C ... 1800 °C	200 °C ... 1650 °C	L: 100 °C ... 1200 °C H: 250 °C ... 1650 °C HF: 200 °C ... 1650 °C	0 °C ... 710 °C	700 °C ... 1800 °C
0.1 K	0.1 K	0.1 K	0.1 K	0.1 K	0.5 K	0.1 K (> 900 °C)
L: 150:1 H: 300:1	L: 60:1 / H: 100:1 / H1-H3: 300:1	H: 100:1 H1-H3: 300:1	45:1	L/HF: 45:1 H: 70:1	45:1	40:1
–	–	–	–	–	–	–
0.5 mm @ 150 mm	0.5 mm @ 150 mm	0.5 mm @ 150 mm	1.6 mm @ 70 mm	1 mm @ 70 mm	1.6 mm @ 70 mm	7.7 mm @ 305 mm
3.7 mm @ 1100 mm	11 mm @ 1100 mm	11 mm @ 1100 mm	27 mm @ 1200 mm	17 mm @ 1200 mm	27 mm @ 1200 mm	31.3 mm @ 1143 mm
Double laser	Double laser	–	Double laser	Double laser	Double laser	Laser
1 ms	1 ms	1 ms	10 ms	L: 120 ms / H: 80 ms HF: 10 ms	150 ms	5 ms – 10 s
±(0,3% T _{meas} + 2 °C)	±(0,3% T _{meas} + 2 °C)	±(0,3% T _{meas} + 2 °C)	±1.5 °C or ±1 %	±1.5 °C or ±1 %	±1.5 °C or ±1 %	±(1% T _{meas} + 1 °C)
■ / ■ / ■ / ■ / ■	■ / ■ / ■ / ■ / ■	■ / ■ / ■ / ■ / ■	■ / ■ / ■ / ■ / ■	■ / ■ / ■ / ■ / ■	■ / ■ / ■ / ■ / ■	■ / ■ / ■ / ■ / –
–	–	–	■	■	■	–
■ / ■ / ■ / ■ / ■	■ / ■ / ■ / ■ / ■	■ / ■ / ■ / ■ / ■	■ / ■ / ■ / ■ / ■	■ / ■ / ■ / ■ / ■	■ / ■ / ■ / ■ / ■	– / – / – / – / –
■ / ■ / ■ / ■	■ / ■ / ■ / ■	■ / ■ / ■ / ■	■ / ■ / ■ / ■	■ / ■ / ■ / ■	■ / ■ / ■ / ■	■ / ■ / ■ / ■
–20 °C	–20 °C	–20 °C	–20 °C	–20 °C	–20 °C	–20 °C
85 °C	85 °C	85 °C	85 °C	85 °C	85 °C	250 °C
85 °C	85 °C	85 °C	85 °C	85 °C	85 °C	85 °C
■ / 3	■ / 3	■ / 3	■ / 3	■ / 3	■ / 3	– / –
■	■	■	■	■	■	–
■	■	■	■	■	■	–
■	■	■	■	■	■	■ (via I/O pins)
–	–	–	–	–	–	■ / 2
■	■	■	■	■	■	■
■	■	■	■	■	■	■
■	■	■	■	■	■	■ (via I/O pins)
8–36 V DC	8–36 V DC	8–36 V DC	8–36 V DC	8–36 V DC	8–36 V DC	8–36 V DC
3 m	3 m	3 m	3 m	3 m	3 m	3 m
8 / 15 m	8 / 15 m	–	8 / 15 m	8 / 15 m	8 / 15 m	6 / 10 / 15 / 22 m

Infrared video thermometers

Infrared video thermometers with vario focus and patented cross hair laser



Base model	CSvideo	CTvideo	CTvideo
Type	2M (L/H)	1M / 2M (L/H)	3M (L/H)
Classification / special features	Single-piece two wire sensor with electronics in sensing head, video camera and cross hair laser for measuring metal	Two-piece sensor with electronic box for high temperature measurement of metals, video camera and cross hair laser	Two-piece sensor with electronic box for low temperature measurement of metals, video camera and cross hair laser
Detector	InGaAs	1M: Si / 2M: InGaAs	Extended InGaAs
Sensing head exchangeable	–	[+CT 1M / 2M]	[+CT 3M]
Head cable shortening	■	[max. 6 m]	[max. 6 m]
Thread (sensing head)	M48x1.5	M48x1.5	M48x1.5
Spectral range	1.6 μm	1M: 1.0 μm / 2M: 1.6 μm	2.3 μm
Temperature ranges (scalable via software)	250 °C ... 800 °C (2ML) 385 °C ... 1600 °C (2MH)	485 °C ... 1050 °C (1ML) 650 °C ... 1800 °C (1MH) 800 °C ... 2200 °C (1MH1) 250 °C ... 800 °C (2ML) 385 °C ... 1600 °C (2MH) 490 °C ... 2000 °C (2MH1)	50 °C ... 400 °C (3ML) 100 °C ... 600 °C (3MH) 150 °C ... 1000 °C (3MH1) ¹⁾ 200 °C ... 1500 °C (3MH2) ¹⁾ 250 °C ... 1800 °C (3MH3) ¹⁾
Temperature resolution	0.1 K	0.1 K	0.1 K
Optical resolution	2MH: 300:1 / 2ML: 150:1	L: 150:1 / H: 300:1	L: 60:1 / H: 100:1 / H1 – H3: 300:1
Smallest spot (CF optics) CF vario optics: focusable from 90 mm to 250 mm	2ML: 0.6 mm @ 90 mm (CF) 2MH: 0.3 mm @ 90 mm (CF)	1ML/2ML: 0.6 mm @ 90 mm (CF) 1MH-H1/ 2MH-H1: 0.3 mm @ 90 mm (CF)	3ML: 1.5 mm @ 90 mm (CF) 3MH: 0.9 mm @ 90 mm (CF) 3MH1 – H3: 0.3 mm @ 90 mm (CF)
Smallest spot (SF optics) SF vario optics: focusable from 200 mm to infinity	2ML: 1.3 mm @ 200 mm (SF) 2MH: 0.7 mm @ 200 mm (SF)	1ML/2ML: 1.3 mm @ 200 mm (SF) 1MH-H1/ 2MH-H1: 0.7 mm @ 200 mm (SF)	3MH: 3.3 mm @ 200 mm (SF) 3MH: 2.0 mm @ 200 mm (SF) 3MH1 – H3: 0.7 mm @ 200 mm (SF)
Sighting	video camera and cross hair laser	video camera and cross hair laser	video camera and cross hair laser
Response time (90 %)	10 ms	1 ms	1 ms
Accuracy	$\pm(0.3\% T_{\text{meas}} + 2\text{ °C})$	$\pm(0.3\% T_{\text{meas}} + 2\text{ °C})$	$\pm(0.3\% T_{\text{meas}} + 2\text{ °C})$
Outputs analog: 0–20 mA / 4–20 mA / 0–5 V / 0–10 V / t/c (K/J)	– / ■ / – / – / –	■ / ■ / ■ / ■ / ■	■ / ■ / ■ / ■ / ■
Interfaces: USB / RS232 / RS485 / Profibus / Ethernet	■ / – / – / – / ■	■ / – / – / – / ■	■ / – / – / – / ■
Signal processing: Peak / Valley / AVG / Advanced hold	■ / ■ / ■ / ■	■ / ■ / ■ / ■	■ / ■ / ■ / ■
T _{Amb} Head min.	–20 °C	–20 °C	–20 °C
T _{Amb} Head max.	70 °C	70 °C	70 °C
T _{Amb} Electronics max.	70 °C	85 °C	85 °C
Functional inputs / number	– / –	■ / 3	■ / 3
External emissivity adjustment	–	■	■
External background temperature control	–	■	■
Trigger input for reset of hold functions	–	■	■
Simultaneous analog and digital output	■	■	■
Alarm output as an alternative to analog output	■	■	■
Additional alarm output	0–30 V / 500 mA (open-collector)	24 V / 50 mA (open-collector)	24 V / 50 mA (open-collector)
Voltage supply	5–28 V DC	8–36 V DC	8–36 V DC
Standard cable length	3 m	3 m	3 m
Cable length options	8 / 15 m	5 / 10 m	5 / 10 m

¹⁾ Specifications available for object temperatures \geq lower measurement range 50 °C

Software included

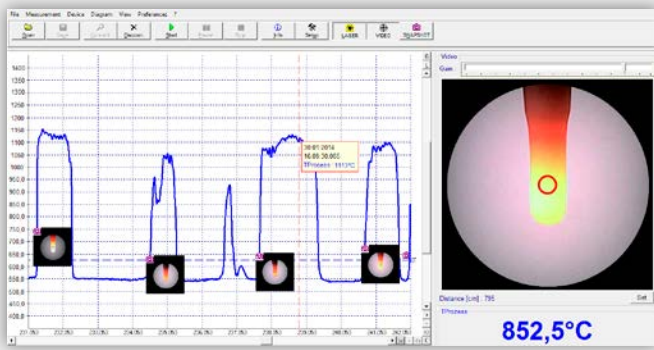

- Automatic snapshots (time or temperature dependent) to control and document the process
- Graphic display and recording of the measurement values
- Setup of sensor parameters and signal processing functions
- Remote control of the sensor

Connection options for CSvideo 2M

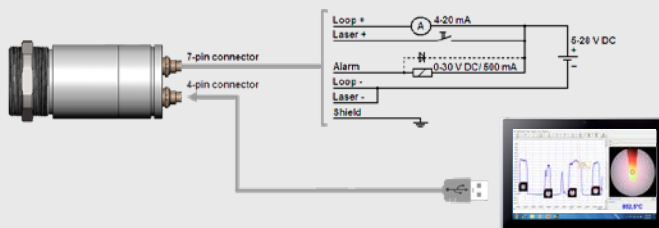

Analog operation mode: 4–20 mA and alarm interface. Setup & installation via USB cable (hot Plug & Play)



Digital operation mode: process control (video and temperature) via software

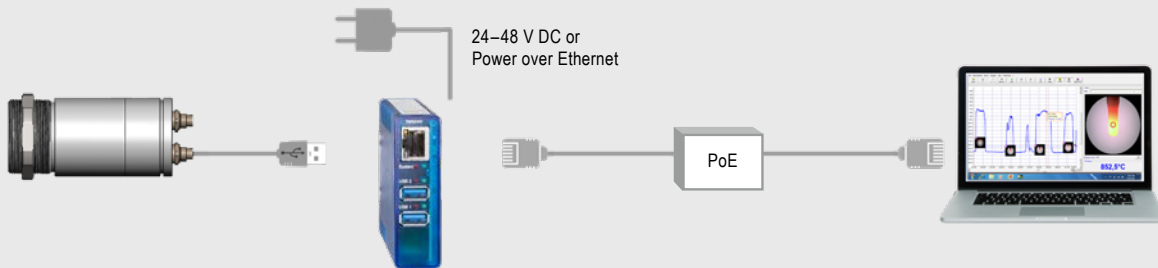

Connection options for CTvideo 1M / 2M / 3M

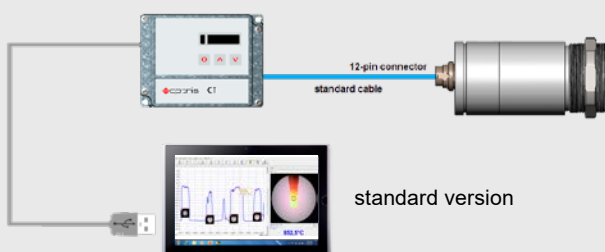

standard version

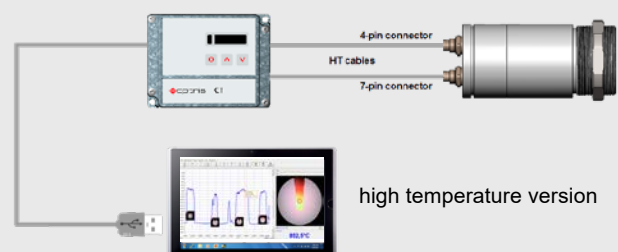

high temperature version

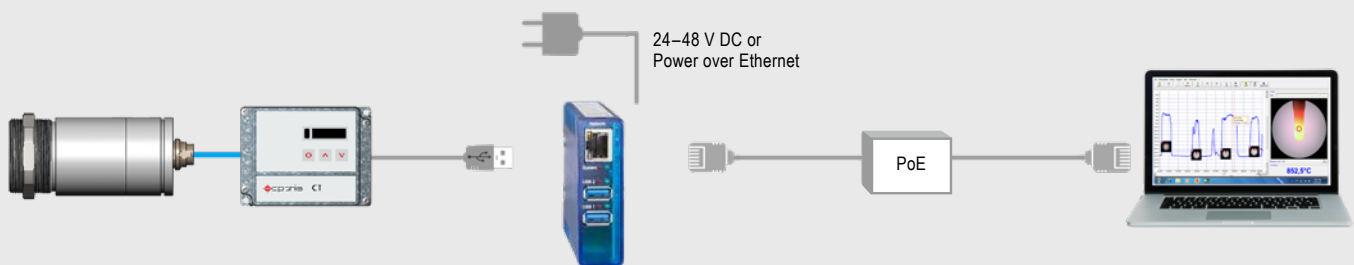

Accessories High performance series

Mechanical accessories

			
ACCTLFB Mounting bracket, adjustable in one axis	ACCTLAB Mounting bracket, adjustable in two axes	ACCJAB Mounting bracket for CoolingJacket, adjustable in two axes	ACCTXLAB Mounting bracket CT XL, adjustable in two axes
			
ACHAMA Mounting adapter: Mounting and pipe flange	ACCTCOV Closed cover for CT electronic box	ACCTRAIL Rail mount adapter for CT electronics	ACCTLT20UN Thread adapter M48x1,5 to 20 UN-2A thread incl. mounting nut

Air purges and cooling units

		
ACCTAPMH Air purge collar CTratio	ACCTLAP Air purge collar CxL/ CxV	ACCTLW Water cooled housing CxL/ CxV, stainless steel, for T_{amb} up to 175 °C
		
ACCTLCJ CoolingJacket (stainless steel) for CSlaser/ CTlaser/ CSvideo/ CTvideo	ACCTXLAP Air purge collar CT XL	

Optical accessories

		
<p>ACHAST300 + ACHAPA Sighting tube M48x1,5, 300 mm length + pipe adapter with M48x1,5 internal thread</p>	<p>ACCJAFUxx + ACCJAPWPI2xxLW / ACCJAFUxx + ACCJAPWCTLSW Focussing unit with protective window for CoolingJacket</p>	<p>ACCJAFUxx + ACCJAPGMS 2 or 3 Focussing unit with protective grid for CoolingJacket Advanced</p>

Combinations

					
<p>CT electronic box</p>	<p>ACCTRAIL Rail mount adapter</p>	<p>Electronic box on rail mount adapter</p>	<p>ACHAMA Mounting adapter</p>	<p>ACHAST300 / ACHAPA Sighting tube / pipe adapter</p>	<p>ACCTLRM Furnace wall mount for CSLaser/ CTlaser</p>
					
<p>CT electronic box</p>	<p>ACCTCOV Closed cover for CT electronic box</p>	<p>Closed CT electronic box</p>	<p>ACCTLAP Air purge</p>	<p>ACCTLW Water cooled housing</p>	<p>Cooling sensing head + purging of optics</p>
					
<p>ACCTLCJA CoolingJacket Advanced</p>	<p>ACCJAAPLS Air purge laminar for CoolingJacket Advanced</p>	<p>CoolingJacket Advanced with air purge laminar</p>			

Portable thermometers



Base Model	LS	P20	P20	MS	MSPlus	MSPro
Type	LT	LT	1M / 2M / 05M	LT	LT	LT
Detector	Thermopile	Thermopile	Si / InGaAs	Thermopile	Thermopile	Thermopile
Spectral range	8 – 14 μm	8 – 14 μm	1M: 1.0 μm 2M: 1.6 μm 05M: 525 nm	8 – 14 μm	8 – 14 μm	8 – 14 μm
Temperature ranges	-35 °C ... 900 °C	0 °C ... 1300 °C	1M: 650 °C ... 1800 °C 2M: 385 °C ... 1600 °C 05M: 1000 °C ... 2000 °C	-32 °C ... 420 °C	-32 °C ... 530 °C	-32 °C ... 760 °C
Temperature resolution	0,1 K	1 K	1 K	0.2 K	0.1 K	0.1 K
Optical resolution	75:1	120:1	1M / 2M: 300:1 05M: 150:1	20:1	20:1	40:1
Switchable optics	■	-	-	-	-	-
Smallest spot (CF optics)	1 mm @ 62 mm	-	-	-	-	-
Smallest spot (SF optics)	16 mm @ 1200 mm	100 mm @ 12 m	1M / 2M: 12 mm @ 3.6 m 05M: 24 mm @ 3.6 m	13 mm @ 140 mm	13 mm @ 140 mm	13 mm @ 260 mm
Sighting	Cross hair laser	Double laser	Double laser	Laser	Laser	Laser
Response time (90 %)	150 ms	300 ms	100 ms	300 ms	300 ms	300 ms
Accuracy (at T_{Amb} 23 \pm 5 °C)	\pm 0.75% (100 °C ... 900 °C) \pm 0.75 °C (20 °C ... 99.9 °C) \pm 1.5 °C (-20 °C ... 19.9 °C) \pm 2.5 °C (-35 °C ... -20.1 °C)	\pm 2 °C or \pm 1 %	\pm (0.3 % T_{meas} + 2 °C)	\pm 1 °C or \pm 1 %	\pm 1 °C or \pm 1 %	\pm 1 °C or \pm 1 %
PC interface	USB	USB	USB	USB	USB	USB
Software	■	■	■	■	■	■
Probe connection (t/c)	■	-	-	-	-	■
T_{Amb} Min. / Max.	0 °C / 50 °C	0 °C / 50 °C	0 °C / 50 °C	0 °C / 50 °C	0 °C / 50 °C	0 °C / 50 °C
Display MAX / MIN / HOLD	■	■	■	■	■	■
HIGH / LOW alarm	■	■	■	-	■	■
Data logger / capacity	■ / 100	■ / 2000	■ / 2000	-	-	■ / 20
Emissivity	0.100 ... 1.100	0.100 ... 1.100	0.100 ... 1.100	0.95 fixed	0.100 ... 1.100	0.100 ... 1.100

Best optics for portable thermometers

The optics of the portable thermometers are designed for mean distances. The **optris® LS LT** comes with a unique, **switchable lens** which means that smaller objects can be precisely measured in a close-up range.

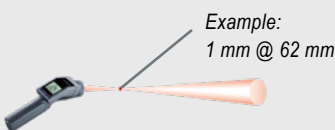

Close lens (CF, close focus): Measurement of smallest objects under test close to the sensor (only optris® LS LT)

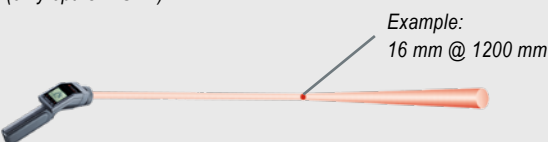

Standard lens (SF, standard focus): Measurement of smallest objects under test in mean distances



optris® Xi Infrared cameras – The Compact Line

innovative infrared technology

Optics calculator: www.optris.global/optics-calculator

Compact spot finder IR camera for applications in rough industrial environments



Basic model	Xi 80	Xi 400
Type	IR	IR
Detector	FPA, uncooled (34 µm Pitch)	FPA, uncooled (17 µm Pitch)
Optical resolution	80 x 80 pixels	382 x 288 pixels
Spectral range	7.5–13 µm	7.5–13 µm
Temperature ranges	–20 °C ... 100 °C 0 °C ... 250 °C (20) 150 °C ... 900 °C ¹⁾	–20 °C ... 100 °C 0 °C ... 250 °C (20) 150 °C ... 900 °C ¹⁾
Frame rate	50 Hz	80 Hz / 27 Hz
Optics (FOV)	30° (f = 5.1) 12° (f = 12.7) 55° (f = 3.1) 80° (f = 2.3)	29° x 22° (f = 12.7) 18° x 14° (f = 20) 53° x 38° (f = 7.7) 80° x 54° (f = 5.7)
Focus	Manual motor focus	Manual motor focus
Optische Auflösung (D:S)	190:1 (12° optics)	390:1 (18° optics)
Thermal sensitivity (NETD)	100 mK	80 mK
Accuracy	±2 °C or ±2 %, whichever is greater	±2 °C or ±2 %, whichever is greater
PC interfaces	USB 2.0 / Ethernet (100 Mbit/s) / PoE / RS 485 ²⁾	USB 2.0 / optional USB to GigE (PoE) interface
Direct in-/outputs / Standard process interface (PIF)	1x 0/4–20 mA output 1x input (analog or digital) Optically isolated	1x 0–10 V input 1x digital input (max. 24 V) 1x 0–10 V output
Industrial process interface (PIF)	3x 0/4 – 20 mA or 0–10 V outputs, 3x input (analog or digital), 3x relays (0 – 30 V) / 400 mA), 1x fail-safe relay; stackable up to 3 PIFs; optically isolated	2 x 0–10 V inputs, 1x digital input (max. 24 V) 3 x 0–10 V outputs, 3 x relays (0–30 V / 400 mA), 1x fail-safe relay
Cable length (USB)	USB: 1 m (standard), 3 m, 5 m, 10 m und 20 m Ethernet / RS485: 100 m	USB: 1 m (standard), 3 m, 5 m, 10 m und 20 m
Ambient temperature	0 °C ... 50 °C	0 °C ... 50 °C
Size / class	Ø 36 x 90 mm (M30x1 thread) / IP 67 (NEMA 4)	Ø 36 x 100 mm (M30x1 thread) / IP 67 (NEMA 4)
Weight	185 g	200 g
Shock/ Vibration ³⁾	IEC 60068-2	IEC 60068-2
Power supply	USB / PoE / 5-30 VDC	via USB
Scope of supply (standard)	<ul style="list-style-type: none"> • Xi camera • USB cable (1 m) • Cable for in-/outputs (1 m) with terminal block • Mounting bracket with tripod thread, mounting nut • Software package optris® PIX Connect • Quick start guide 	<ul style="list-style-type: none"> • Xi camera • USB cable (1 m) • Cable for in-/outputs (1 m) with terminal block • Mounting bracket with tripod thread, mounting nut • Software package optris® PIX Connect • Quick start guide

¹⁾ Accuracy effective starting at 150 °C

²⁾ Direct in- and outputs are not available while using the RS485 interface

³⁾ For further details see operator's manual

optris® PI infrared cameras - the Precision Line



Basic model	PI 160	PI 200 / PI 230	PI 400 / PI 450
Type	IR	BI-SPECTRAL	IR
Detector	FPA, uncooled (25 µm pitch)	FPA, uncooled (25 µm pitch)	FPA, uncooled (25 µm pitch)
Optical resolution	160 x 120 pixels	160 x 120 pixels	382 x 288 pixels
Spectral range	7.5–13 µm	7.5–13 µm	7.5–13 µm
Temperature ranges	-20 ... 100 °C, 0 ... 250 °C, (20) 150 ... 900 °C ¹⁾ , 200 ... 1500 °C (option) ²⁾	-20 ... 100 °C, 0 ... 250 °C, (20) 150 ... 900 °C ¹⁾ , 200 ... 1500 °C (option) ²⁾	-20 ... 100 °C, 0 ... 250 °C, (20) 150 ... 900 °C ¹⁾ , 200 ... 1500 °C (option) ²⁾
Frame rate	120 Hz	128 Hz ⁴⁾	80 Hz / switchable to 27 Hz
Optics (FOV)	23° x 17° / f = 10 mm or 6° x 5° / f = 35.5 mm or 41° x 31° / f = 5.7 mm or 72° x 52° / f = 3.3 mm	23° x 17° ³⁾ / f = 10 mm or 6° x 5° / f = 35.5 mm or 41° x 31° ³⁾ / f = 5.7 mm or 72° x 52° / f = 3.3 mm	29° x 22° / f = 18.7 mm or 13° x 10° / f = 41 mm or 53° x 40° / f = 10.5 mm or 80° x 56° / f = 7.7 mm
Thermal sensitivity (NETD)	0.08 K with 23° x 17° FOV / F = 0.8 0.3 K with 6° x 5° FOV / F = 1.6 0.1 K with 41° x 31° FOV and 72° x 52° FOV / F = 1	0.08 K with 23° x 17° FOV / F = 0.8 0.3 K with 6° x 5° FOV / F = 1.6 0.1 K with 41° x 31° FOV and 72° x 52° FOV / F = 1	PI 400: 0.08 K with 29°, 53°, 80° FOV PI 450: 0.04 K with 29°, 53°, 80° FOV optics mentioned above: F = 0.8 PI 400: 0.1 K with 13° FOV / F = 1.0 PI 450: 0.06 K with 13° FOV / F = 1.0
Option visual camera (BI-SPECTRAL camera only)	–	Optical resolution: 640 x 480 pixels Frame rate: 32 Hz ⁴⁾ Optics (FOV): PI 200: 54° x 40°, PI 230: 30° x 23°	–
Accuracy	±2 °C or ±2 %, whichever is greater	±2 °C or ±2 %, whichever is greater	±2 °C or ±2 %, whichever is greater
PC interfaces	USB 2.0 / optional USB to GigE (PoE) Interface	USB 2.0 / optional USB to GigE (PoE) Interface	USB 2.0 / optional USB to GigE (PoE) Interface
Process interface (PIF)	Standard PIF 1x 0–10 V input, 1x digital input (max. 24 V), 1x 0–10 V output Industrial PIF (optional) 2x 0–10 V inputs, 1x digital input (max. 24 V), 3x 0–10 V outputs, 3x relays (0–30 V/400 mA), 1x fail-safe relay	1x 0–10 V input, 1x digital input (max. 24 V), 1x 0–10 V output 2x 0–10 V inputs, 1x digital input (max. 24 V), 3x 0–10 V outputs, 3x relays (0–30 V/400 mA), 1x fail-safe relay	1x 0–10 V input, 1x digital input (max. 24 V), 1x 0–10 V output 2x 0–10 V inputs, 1x digital input (max. 24 V), 3x 0–10 V outputs, 3x relays (0–30 V/400 mA), 1x fail-safe relay
Ambient temperature (T _{Amb})	0 ... 50 °C	0 ... 50 °C	PI 400: 0 ... 50 °C / PI 450: 0 ... 70 °C
Storage temperature	-40 ... 70 °C	-40 ... 70 °C	PI 400: -40 ... 70 °C PI 450: -40 ... 85 °C
Relative Humidity	20–80 %, non-condensing	20–80 %, non-condensing	20–80 %, non-condensing
Size / class	45 x 45 x 62 mm / IP 67 (NEMA 4)	45 x 45 x 62 mm / IP 67 (NEMA 4)	46 x 56 x 90 mm / IP 67 (NEMA 4)
Weight	195 g, incl. lens	215 g, incl. lens	320 g, incl. lens
Shock/ Vibration	IEC 60068-2	IEC 60068-2	IEC 60068-2
Tripod mount	1/4-20 UNC	1/4-20 UNC	1/4-20 UNC
Power supply	via USB	via USB	via USB
Scope of supply (standard)	<ul style="list-style-type: none"> • USB camera with 1 lens • USB cable (1 m) • Table tripod • PIF cable with terminal block (1 m) • Manual • Software package optris® PIX Connect • Aluminum case 	<ul style="list-style-type: none"> • USB camera with 1 lens and BI-SPECTRAL technology • USB cable (1 m) • Table tripod • Focussing tool • PIF cable with terminal block (1 m) • Manual • Software package optris® PIX Connect • Aluminum case 	<ul style="list-style-type: none"> • USB camera with 1 lens • USB cable (1 m) • Table tripod • PIF cable with terminal block (1 m) • Manual • Software package optris® PIX Connect • Aluminum case (PI 400) • Robust hard shell case (PI 450)

¹⁾ Accuracy effective starting at 150 °C

²⁾ The additional measuring range is not available for the 72° (PI 160 / 2xx), 80° (PI 4xx) and 90° (PI 640) optics

³⁾ For the best combination of IR- and VIS image, we recommend the 41° HFOV optics for the PI 200 and the 23° HFOV optics for the PI 230



PI 640	Microscope optics PI 450	Microscope optics PI 640
IR	IR	IR
FPA, uncooled (17 µm pitch)	FPA, (25 µm pitch)	FPA, (17 µm pitch)
640 x 480 pixels VGA	382 x 288 pixels @ 80 Hz (switchable to 27 Hz)	640 x 480 pixels @ 32 Hz 640 x 120 pixels @ 125Hz
7.5 – 13 µm	7.5 – 13 µm	7.5 – 13 µm
-20 ... 100 °C, 0 ... 250 °C, (20) 150 ... 900 °C ¹⁾ , 200 ... 1500 °C (option) ²⁾	-20 ... 100 °C 0 ... 250 °C (20) 150 ... 900 °C ¹⁾	-20 ... 100 °C 0 ... 250 °C (20) 150 ... 900 °C ¹⁾
32 Hz / 125 Hz in subframe mode (640x120 pixels)		Up to 1 kHz / 1 ms real time analog output (0 - 10 V) of 8 x 8 pixels (freely selectable)
33° x 25° / f = 18.7 mm or 15° x 11° / f = 41.5 mm or 60° x 45° / f = 10.5 mm or 90° x 64° / f = 7.7 mm	10° x 8° (F=1.1) / f = 44 mm Smallest measuring spot: 42 µm	12° x 9° (F=1.1) / f = 44 mm Smallest measuring spot: 28 µm
75 mK	90 mK	120 mK
-	-	-
±2 °C or ±2 %, whichever is greater	±2 °C or ±2 %, whichever is greater	±2 °C or ±2 %, whichever is greater
USB 2.0 / optional USB to GigE (PoE) Interface	USB 2.0 / optional USB to GigE (PoE) Interface	USB 2.0 / optional USB to GigE (PoE) Interface
1x 0 – 10 V input, 1x digital input (max. 24 V), 1x 0 – 10 V output	1x 0 – 10 V input, 1x digital input (max. 24 V), 1x 0 – 10 V output	1x 0 – 10 V input, 1x digital input (max. 24 V), 1x 0 – 10 V output
2x 0 – 10 V inputs, 1x digital input (max. 24 V), 3x 0 – 10 V outputs, 3x relays (0 – 30 V/400 mA), 1x fail-safe relay	2x 0 – 10 V inputs, 1x digital input (max. 24 V), 3x 0 – 10 V outputs, 3x relays (0 – 30 V/400 mA), 1x fail-safe relay	2x 0 – 10 V inputs, 1x digital input (max. 24 V), 3x 0 – 10 V outputs, 3x relays (0 – 30 V/400 mA), 1x fail-safe relay
0 ... 50 °C	0 ... 70 °C	5 ... 50 °C
-40 ... 70 °C	-40 ... 70 °C	-40 ... 70 °C
20 – 80 %, non-condensing	20 – 80 %, non-condensing	20 – 80 %, non-condensing
46 x 56 x 90 mm / IP 67 (NEMA 4)	46 x 56 x 134 mm / IP 67 (NEMA 4)	46 x 56 x 134 mm / IP 67 (NEMA 4) ⁶⁾
320 g, incl. lens	370 g, incl. lens	320 g, incl. lens
IEC 60068-2	IEC 60068-2	IEC 60068-2
1/4 - 20 UNC	1/4 - 20 UNC	1/4 - 20 UNC
via USB	via USB	via USB
<ul style="list-style-type: none"> • USB camera with 1 lens • USB cable (1 m) • Table tripod • PIF cable with terminal block (1 m) • Manual • Software package optris® PIX Connect • Robust hard shell case 	<ul style="list-style-type: none"> • USB camera • Standard lens (PI 450: O29; PI 640: O33) • Microscope lens (MO44) • Microscope stand • Standard USB cable (1 m) • Standard-PIF • Manual • Robust hard shell case • Software package optris® PIX Connect 	<ul style="list-style-type: none"> • USB camera • Standard lens (PI 450: O29; PI 640: O33) • Microscope lens (MO44) • Microscope stand • Standard USB cable (1 m) • Standard-PIF • Manual • Robust hard shell case • Software package optris® PIX Connect

⁴⁾ The following options may be chosen:
 Option 1 (IR with 96 Hz at 160 x 120 px; VIS with 32 Hz at 640 x 480 px)
 Option 2 (IR with 128 Hz at 160 x 120 px; VIS with 32 Hz at 596 x 447 px)

optris® PI infrared cameras - the *Precision Line*

Compact infrared cameras for fast online applications, including linescanner



Basic model		PI 450 G7	PI 640 G7
Type		IR	IR
Detector		FPA, uncooled (25 µm pitch)	FPA, uncooled (17 µm pitch)
Optical resolution		382 x 288 pixels	640 x 480 pixels
Spectral range		7.9 µm	7.9 µm
Temperature range		200 ... 1500 °C	200 ... 1500 °C
Frame rate		80 Hz / switchable to 27 Hz	32 Hz / 125 Hz in subframe mode (640x120 pixels)
Optics (FOV)		29° x 22° (f = 18.7 mm) 13° x 10° (f = 41 mm) 53° x 40° (f = 10.5 mm) 80° x 56° (f = 7.7 mm)	33° x 25° (f = 18.7 mm) 15° x 11° (f = 42 mm) 60° x 45° (f = 10.5 mm) 90° x 64° (f = 7.7 mm)
Thermal sensitivity (NETD)		130 mK	130 mK
Accuracy		±2 °C or ±2 %, whichever is greater	±2 °C or ±2 %, whichever is greater
PC interfaces		USB 2.0 / optional USB to GigE (PoE) interface	USB 2.0 / optional USB to GigE (PoE) interface
Process interface (PIF)	Standard PIF	1x 0 – 10 V input, 1x digital input (max. 24 V), 1x 0 – 10 V output	1x 0 – 10 V input, 1x digital input (max. 24 V), 1x 0 – 10 V output
	Industrial PIF (optional)	2x 0 – 10 V inputs, 1x digital input (max. 24 V), 3x 0 – 10 V outputs, 3x relays (0 – 30 V/ 400 mA), 1x fail-safe relay	2x 0 – 10 V inputs, 1x digital input (max. 24 V), 3x 0 – 10 V outputs, 3x relays (0 – 30 V/ 400 mA), 1x fail-safe relay
Ambient temperature (T _{Um})		0 ... 70 °C	0 ... 50 °C
Storage temperature		-40 ... 85 °C	-40 ... 70 °C
Relative Humidity		20 – 80 %, non-condensing	20 – 80 %, non-condensing
Size / class		46 x 56 x 90 mm / IP 67 (NEMA 4)	46 x 56 x 90 mm / IP 67 (NEMA 4)
Weight		320 g, incl. lens	320 g, incl. lens
Shock/ Vibration		IEC 60068-2	IEC 60068-2
Tripod mount		1/4 - 20 UNC	1/4 - 20 UNC
Power supply		via USB	via USB
Scope of supply (standard)		<ul style="list-style-type: none"> • USB camera with 1 lens • USB cable (1 m) • Table tripod • PIF cable with terminal block (1 m) • Manual • Software package optris® PIX Connect • Robust hard shell case 	<ul style="list-style-type: none"> • USB camera with 1 lens • USB cable (1 m) • Table tripod • PIF cable with terminal block (1 m) • Manual • Software package optris® PIX Connect • Robust hard shell case

Optics calculator: www.optris_global/optics-calculator



PI 1M		PI 05M	
IR		IR	
CMOS (15 µm pitch)		CMOS (15 µm pitch)	
764 x 480 pixels @ 32 Hz 382 x 288 pixels @ 80 Hz (switchable to 27 Hz) 72 x 56 pixels @ 1 kHz 764 x 8 pixels @ 1 kHz (fast linescan mode)		764 x 480 pixels @ 32 Hz 382 x 288 pixels @ 80 Hz (switchable to 27 Hz) 72 x 56 pixels @ 1 kHz 764 x 8 pixels @ 1 kHz (fast linescan mode)	
0.85 – 1.1 µm		500 nm – 540 nm	
450 ⁵⁾ ... 1800 °C (27 Hz mode) 500 ⁵⁾ ... 1800 °C (80 Hz and 32 Hz mode) 600 ⁵⁾ ... 1800 °C (1 kHz mode)		900 ... 2000 °C (27 Hz mode) 950 ... 2000 °C (32/80 Hz mode) 1100 ... 2000 °C (1 kHz mode)	
Up to 1 kHz / 1 ms real time analog output (0 - 10 V) of 8 x 8 pixels (freely selectable)		Up to 1 kHz / 1 ms real time analog output (0 - 10 V) of 8 x 8 pixels (freely selectable)	
FOV @ 764 x 480 px: 39° x 25° (f = 16 mm) 26° x 16° (f = 25 mm) 13° x 8° (f = 50 mm) 9° x 5° (f = 75 mm)	FOV @ 382 x 288 px: 20° x 15° (f = 16 mm) 13° x 10° (f = 25 mm) 7° x 5° (f = 50 mm) 4° x 3° (f = 75 mm)	FOV @ 764 x 480 px: 26° x 16° (f = 25 mm)	FOV @ 382 x 288 px: 13° x 10° (f = 25 mm)
< 1 K (700 °C) < 2 K (1000 °C)		< 2 K (1400 °C) for 27 Hz, 32 Hz, 80 Hz < 2,5 K (1400 °C) for 1 kHz	
±1 % of reading (object temp. <1400 °C)		±1,5 % of reading	
USB 2.0 / optional USB to GigE (PoE) interface		USB 2.0 / optional USB to GigE (PoE) interface	
1x 0 – 10 V input, 1x digital input (max. 24 V), 1x 0 – 10 V output		1x 0 – 10 V input, 1x digital input (max. 24 V), 1x 0 – 10 V output	
2x 0 – 10 V inputs, 1x digital input (max. 24 V), 3x 0 – 10 V outputs, 3x relays (0 – 30 V/ 400 mA), 1x fail-safe relay		2x 0 – 10 V inputs, 1x digital input (max. 24 V), 3x 0 – 10 V outputs, 3x relays (0 – 30 V/ 400 mA), 1x fail-safe relay	
5 ... 50 °C		5 ... 50 °C	
–40 ... 70 °C		–40 ... 70 °C	
20–80 %, non-condensing		20–80 %, non-condensing	
46 x 56 x 104 mm / IP 67 (NEMA 4) ⁶⁾		46 x 56 mm x 104 mm/ IP 67 (NEMA 4) ⁶⁾	
320 g, incl. lens		320 g, incl. lens	
IEC 60068-2		IEC 60068-2	
1/4 - 20 UNC		1/4 - 20 UNC	
via USB		via USB	
<ul style="list-style-type: none"> • USB camera with 1 lens • Lens tube incl. protective window • USB cable (1 m) • Table tripod • PIF cable with terminal block (1 m) • Manual • Software package optris® PIX Connect • Aluminum case • Optional: CoolingJacket, HT cable 		<ul style="list-style-type: none"> • USB camera with 1 lens • Lens tube incl. protective window • USB cable (1 m) • Table tripod • PIF cable with terminal block (1 m) • Software package optris® PIX Connect • Manual • Aluminum case • Optional: CoolingJacket, HT cable 	

⁵⁾ +75 °C higher start temperature for optics with focal length f= 50 mm, f= 75 mm

⁶⁾ Only applies when lens protection tube is used

Infrared cameras

EXPANSION OPTIONS

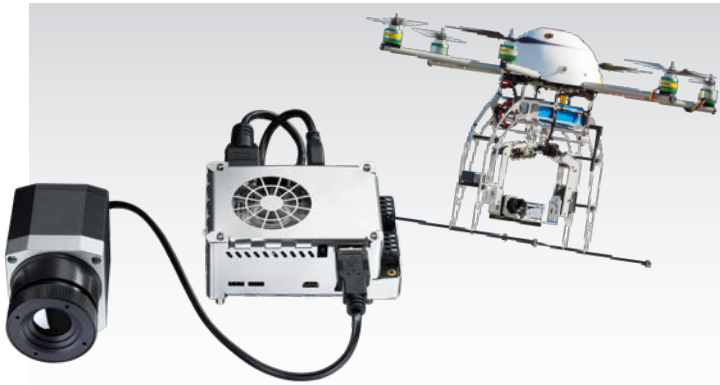

PI LightWeight – Radiometric aerial thermography

Features:

- IR inspection with up to 640x480 pixels and a thermal sensitivity of up to 40 mK for detecting smallest hotspots
- Fully radiometric system with high accuracy of $\pm 2\%$ / $\pm 2\text{ }^\circ\text{C}$ in every pixel
- 380g two-piece design: Allows independent use of IR camera with any Windows PC or tablet PC
- Radiometric on-board real-time recordings with USB 3.0 flash drive
- GPS and GoPro support
- Video recording with low motion blur through high frame rate (32 Hz/ VGA or 125 Hz/ VGA sub-frame mode)
- Free updates for Recording Box software
- Extensive, license-free analysis software PIX Connect included (any number of measuring fields in any shape, snapshot function, hot- and cold spot analysis, temperature profiles etc)
- Remotely controlled recordings and switch between VIS and IR live video



PI NetBox

Features:

- Miniature PC as an add-on to the PI series for stand-alone system or for cable extension via GigE
- Integrated hardware and software watchdog
- Installation of additional user software possible
- Status LEDs
- Processor: Intel® E3845 Quad Core/ 1.91 GHz, 16 GB SSD, 2 GB RAM
- Connections: 2x USB 2.0, 1x USB 3.0, 1x Mini USB 2.0, Micro HDMI, Ethernet (Gigabit Ethernet), Micro SDHC/ SDXC card
- Operating system: Windows 7 Professional
- Wide supply voltage range (8–48 V DC) or Power over Ethernet (PoE)
- Can be integrated into CoolingJacket Advanced



USB Server Gigabit 2.0 – for infrared cameras of optris® PI series and optris® Xi 400

Features:

- Fully USB 2.0 compatible, Data rates: 1.5 / 12 / 480 mbps, USB transfer mode: Isochronous
- Network connection via Gigabit Ethernet
- For optris® PI series and optris® CTvideo/ CSvideo series
- Full TCP/IP support incl. routing and DNS
- Two independent USB ports
- Supply from PoE or external power supply with 24 – 48 V DC
- Galvanic isolation 500 V_{RMS} (network connection)
- Remotely configurable via Web Based Management
- Proven technology from Wiesemann & Theis



Industrial process interface (PIF) for optris® PI series + optris® Xi 400 / for optris® Xi 80

Features:

- Industrial process interface for PI series and Xi 400 with 3 analog/alarm outputs, 2 analog inputs, 1 digital input, 3 alarm relays
- Industrial process interface for Xi 80 with 3 analog-/alarm outputs, 3 inputs (analog or digital), 3 alarm relays
- 500 V_{AC}_{RMS} isolation voltage between camera and process
- Separate fail-safe relay output
- PI / Xi hardware including all cable connections and PIX Connect software are permanently observed during operation
- Option Xi 80: stackable up to 3 PIFs

Connection options for PI LightWeight

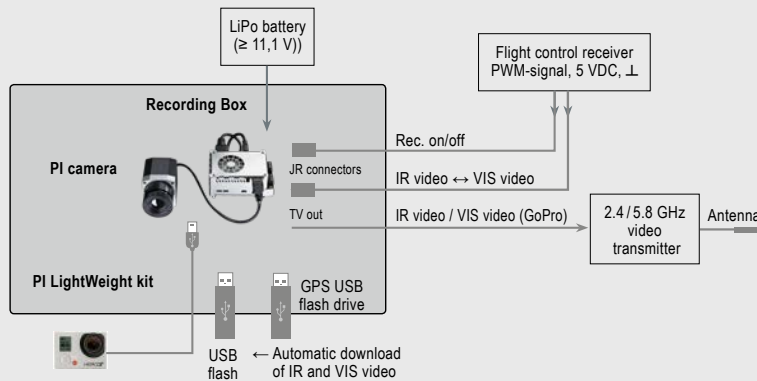

Connection options for PI NetBox

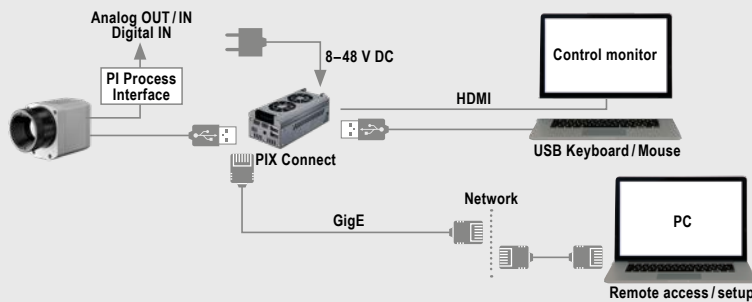

Connection options for USB Server Gigabit 2.0

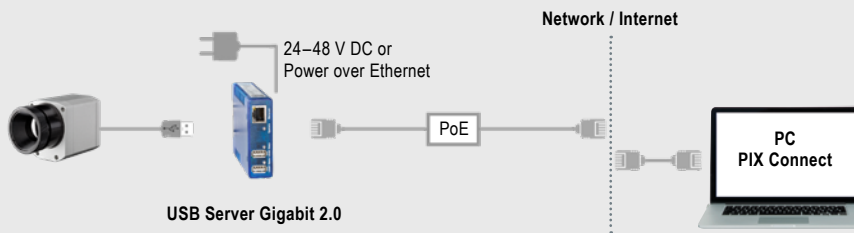

CoolingJacket Advanced

Features:

- Operation at ambient temperatures up to 315 °C
- Air/ water cooling with integrated air purging and optional protective windows
- Modular concept for easy installation of different devices and optics
- Trouble-free sensor disassembling on site with quick release chassis
- Integration of additional components like PI NetBox, USB Server Gigabit 2.0 and Industrial Process Interface (PIF) in extended version



Outdoor protective housing for infrared cameras

Features:

- Environmental rating IP 66
- Additional air purge collar allows for a continuous operation in dusty and humid conditions
- Heating element and built-in fan enable for a 24/7 operation from -40 °C to 50 °C
- Installation of USB Server Gigabit 2.0 and industrial process interface possible for integration into control systems over large outdoor distances

1 Comprehensive IR camera software

- No additional costs
- No licensing restrictions
- Modern software with intuitive user interface
- Remote control of camera via software
- Display of numerous images in different windows
- Compatible with Windows 7, 8 and 10 as well as Linux (ubuntu)
- Extensive license-free analysis and two Software Development Kits for Windows and Linux included



3 High degree of individualization for customer-specific imaging

- Various layout options for individual customization (window arrangement, toolbar)
- Temperature display in °C or °F
- Various language options including translate function
- Choice of individual measurement parameters tailored to the respective application
- Editing of the thermal image (mirroring, rotate)
- Individual start options (full screen, hidden etc.)

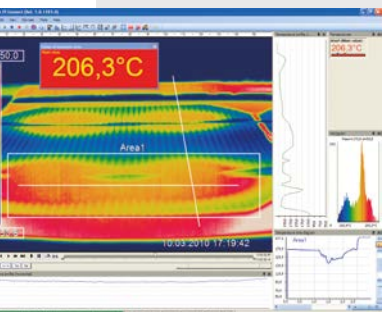

5 Video recording and snapshot function (IR or BI-SPECTRAL)

- Recording of video sequences and individual images for later analysis or documentation
- BI-SPECTRAL video analysis (IR and VIS) to highlight critical temperatures
- Adjustable frame rate to reduce data volume
- Display of snapshot history for direct analysis

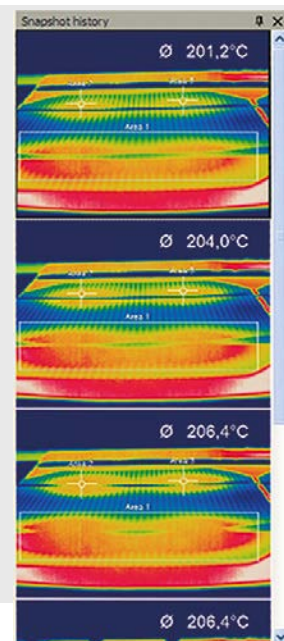

2 Detailed online and offline data analysis

- Real time temperature information in main window, as digital display or graphic display
- Detailed analysis with the help of measurement areas, automatic hotspot and coldspot search
- Logical linking of temperature information (measurement areas discrepancy, image subtraction)
- Slow-motion replay of radiometric datasets and analysis even without connected camera
- Editing of sequences, e.g. cut and save individual images
- Various color palettes to highlight thermal contrasts

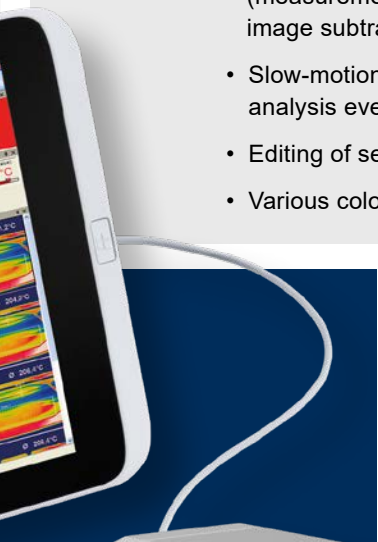
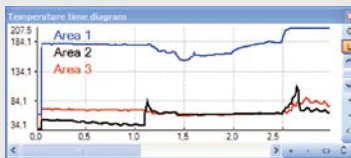
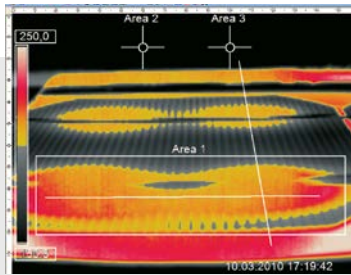

4 Automatic process control and quality control

- Individual setting of alarm thresholds depending on the process
- BI-SPECTRAL monitoring mode (IR and VIS) for easy orientation at the measuring point
- Definition of visual or acoustic alarms and analog data output
- Analog and digital signal input (parameter)
- External communication of software via COM-ports, DLL
- Adjustment of thermal image via reference values
- Measurement areas can be freely designed or created

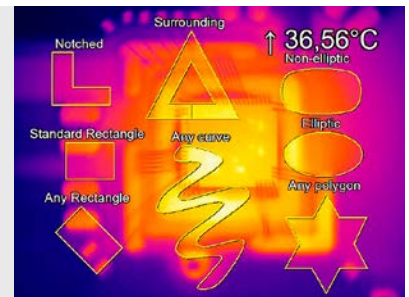

6 Temperature data analysis and documentation

- Triggered data gathering
- Radiometric video sequences (*.ravi)
- Radiometric snapshots (*.tiff)
- Text files including comprehensive temperature information for analysis in Excel (*.csv, *.dat)
- Files with color information for standard programs like Photoshop or Windows Media Player (*.wmf, *.tiff)
- Data transfer in real time to other software programs via DLL or COM-Port interfaces

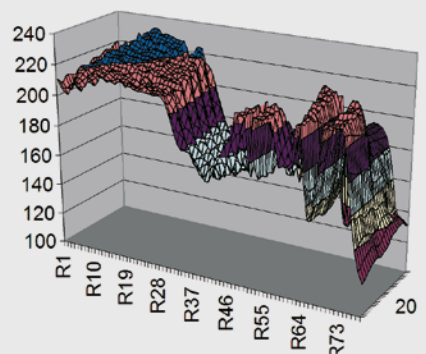

Application fields

Laminating of vehicle interior



Vehicle interiors are partly equipped with different surface decors during a laminating process. The decor temperature is controlled and optimized during this time.

Product: optris® CSmicro LT

Function tests of assembled circuit boards

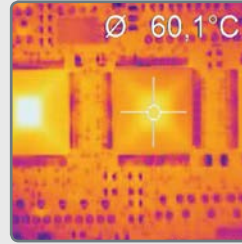

More and more manufacturers of electronic components and circuit boards are turning to the use of non-contact temperature measurement due to the increasing productivity of their components.

Product: optris® PI 450

Production of glass syringes



During the production of glass syringes, the needle is glued to the glass tube. Punctual measuring pyrometers are used to monitor and control the process and ensure the quality of the syringes.

Product: optris® CTfast LT

Hot deforming of metals



Narrow temperature limits need to be met during hot deforming processes of metal. Handheld devices can be used for sporadic monitoring in forging and bending processes.

Product: optris® P20 2M

Induction heating processes



Induction heating has acquired high importance within the area of heat treatment of metal. The aimed-for texture structure of the metal depends on the ideal temperature time process.

Product: optris® CTlaser 1M

Preventive electrical maintenance

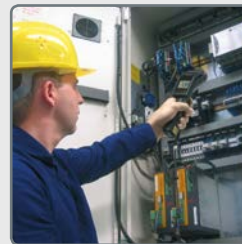

Almost every current asset which is supported by energy turns hot before a breakdown. Temperature monitoring can best be provided in line with preventive electronic maintenance.

Product: optris® LS LT

ateg
Automation GmbH

Autorisierter Systempartner der Optris GmbH:

ATEG Automation GmbH

Intzestr. 50 • 42859 Remscheid • Germany

Tel.: +49 (0)2191 / 591457-0 • Fax: +49 (0)2191 / 591457-77

E-Mail: info@ateg.de • Internet: <http://www.ateg.de>

Optris GmbH
Ferdinand-Buisson-Str. 14
13127 Berlin · Germany
Phone: +49 (0)30 500 197-0
Fax: +49 (0)30 500 197-10
E-mail: info@optris.global
www.optris.global

innovative infrared technology