

EVF159

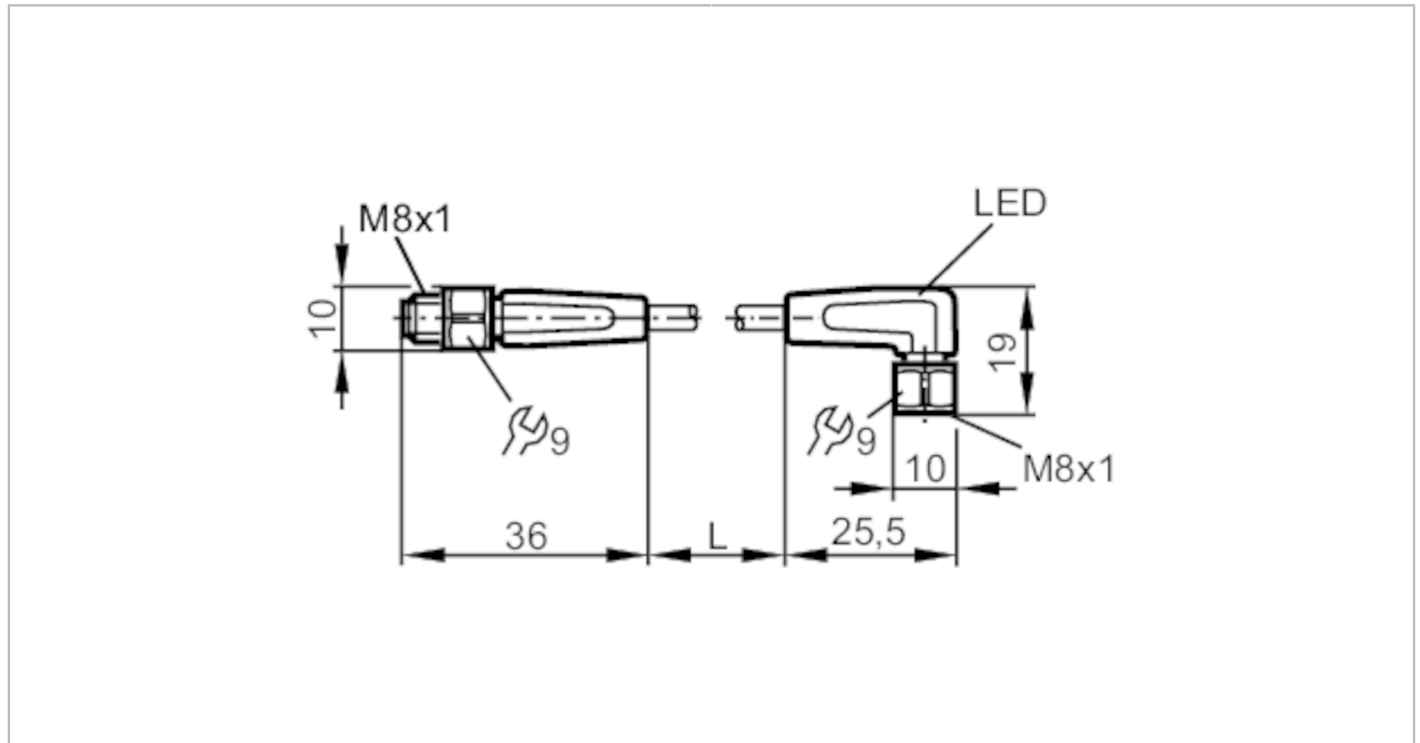

Connection cable

VDOAF032VAS0010P03STGF030VAS



Application	
Special feature	Free from silicone; Halogen-free; Gold-plated contacts; Drag chain suitability
Application	hygienic and wet areas in the food industry
Free from silicone	yes
Electrical data	
Operating voltage [V]	10...36 DC
Protection class	III
Max. current load total [A]	3
Outputs	
Electrical design	PNP
Operating conditions	
Ambient temperature [°C]	-25...80
Ambient temperature (moving) [°C]	5...80
Protection	IP 65; IP 67; IP 68; IP 69K
Tests / approvals	
MTTF [years]	31710

EVF159



Connection cable

VDOAF032VAS0010P03STGF030VAS

Mechanical data		
Weight [g]	290.2	
Dimensions [mm]	10 x 10 x 36	
Materials	housing: PP grey; Sealing: EPDM	
Material nut	stainless steel (1.4404 / 316L) / stainless steel (1.4404 / 316L)	
Drag chain suitability	yes	
Drag chain suitability	bending radius for flexible use	min. 10 x cable diameter
	travel speed	max. 3.3 m/s for a horizontal travel length of 5 m and max. acceleration of 5 m/s ²
	bending cycles	> 1 Mio.
	torsional strain	± 180 °/m

Displays / operating elements		
Display	switching status	1 x LED, yellow
	operation	1 x LED, green

Remarks	
Pack quantity	1 pcs.

Electrical connection - plug

Connector: 1 x M8, straight; Locking: stainless steel (1.4404 / 316L); Contacts: gold-plated; Tightening torque: 0.3...0.5 Nm

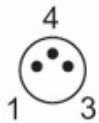

Electrical connection

Cable: 10 m, MPPE, Halogen-free, grey, Ø 4.9 mm; 3 x 0.34 mm² (42 x Ø 0.1 mm)

Connection

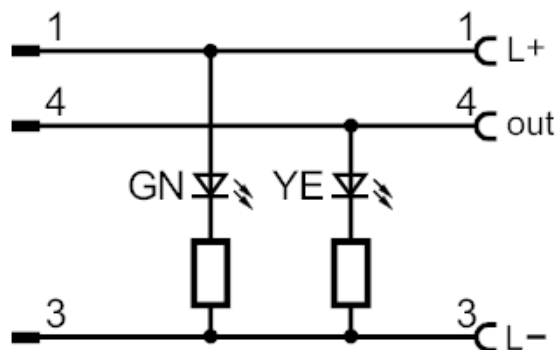

Electrical connection - socket

Connector: 1 x M8, angled; Locking: stainless steel (1.4404 / 316L); Contacts: gold-plated; Tightening torque: 0.3...0.5 Nm

EVF159



Connection cable

VDOAF032VAS0010P03STGF030VAS

