

Manuel de montage

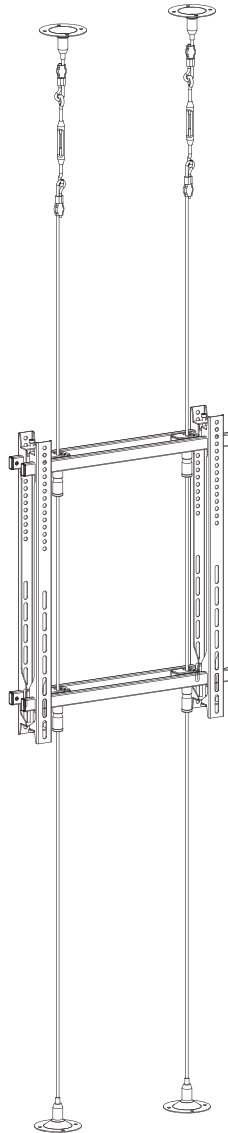



032-2023

Kimex
ÉQUIPEMENTS AUDIOVISUELS







Support filaire 2 écrans 42" - 75" 3m
Wired 2 screens support 42 "- 75" 3m
Capacité : 30kg par écran
Capacity: 30kg per screen
VESA: 400x600mm







Liste



A1	A2	A3	A4
M5X15  X4	M6X15  X4	M8X15  X4	Ø16xØ6.2x1.5  X4

X2

B1	B2	B3	B4
 X2	6mm  X8	Ø16xØ6.2x1.5  X8	Ø6x50  X8

X2

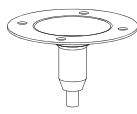
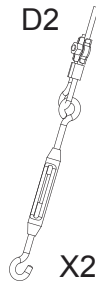
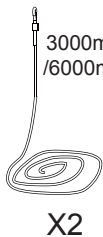
C1	C2	C3	C4	C5	C6
 X1	 X4	 X4	 X4	5mm  X1	 X4

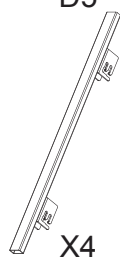
D1	D2	D3	D4	D5
 X4	 X2	3000mm / 6000mm  X2	 X4	 X4

Installation

1

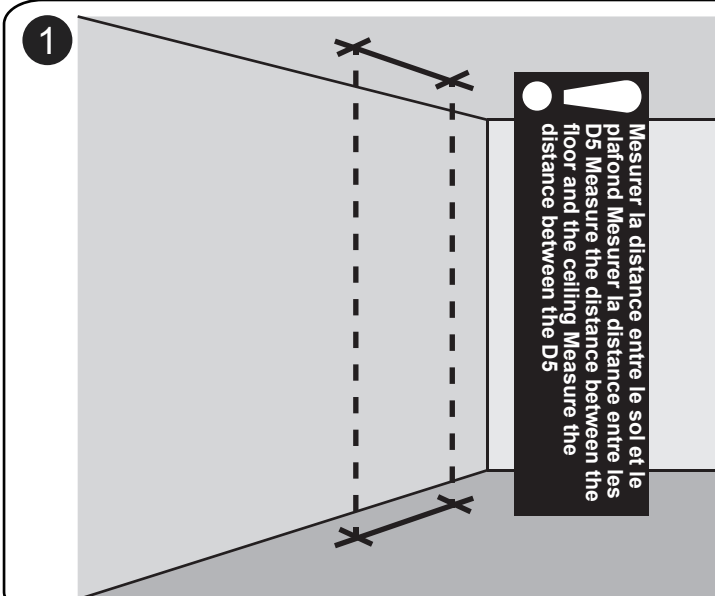

Mesurer la distance entre le sol et le plafond
Mesurer la distance entre les D5
Measure the distance between the floor and the ceiling
Measure the distance between the D5

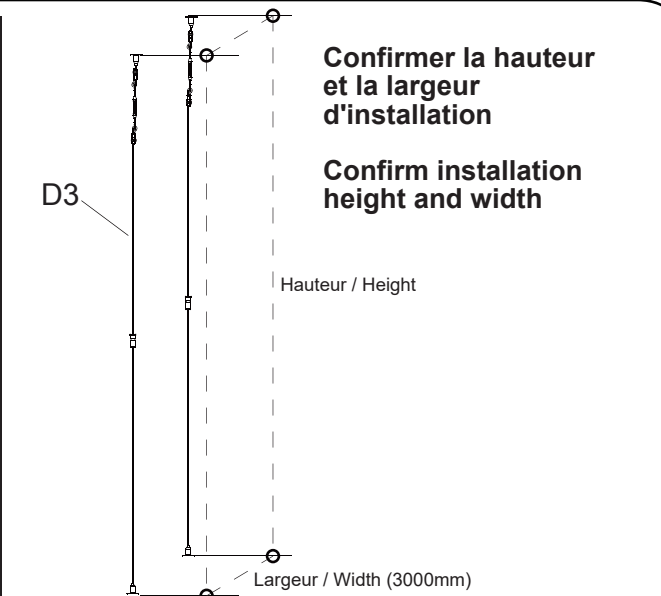

Confirmer la hauteur et la largeur d'installation
Confirm installation height and width

Hauteur / Height

Largeur / Width (3000mm)

2

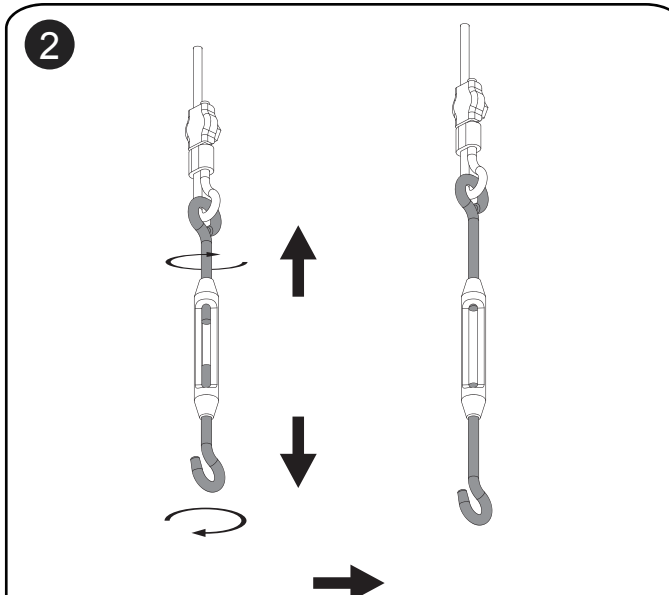

3

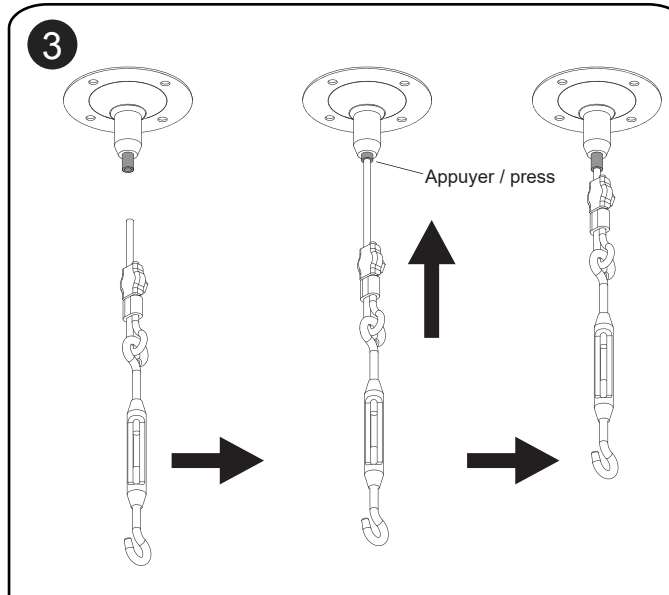

Appuyer / press

