



Datenblatt - Fiche technique - Data sheet

11.04.5547



ROLINE HDMI High Speed Kabel mit Ethernet, schwarz, 10,0 m

ROLINE Câble HDMI High Speed avec Ethernet, noir, 10,0 m

ROLINE HDMI High Speed Cable + Ethernet, M/M, black, 10.0 m

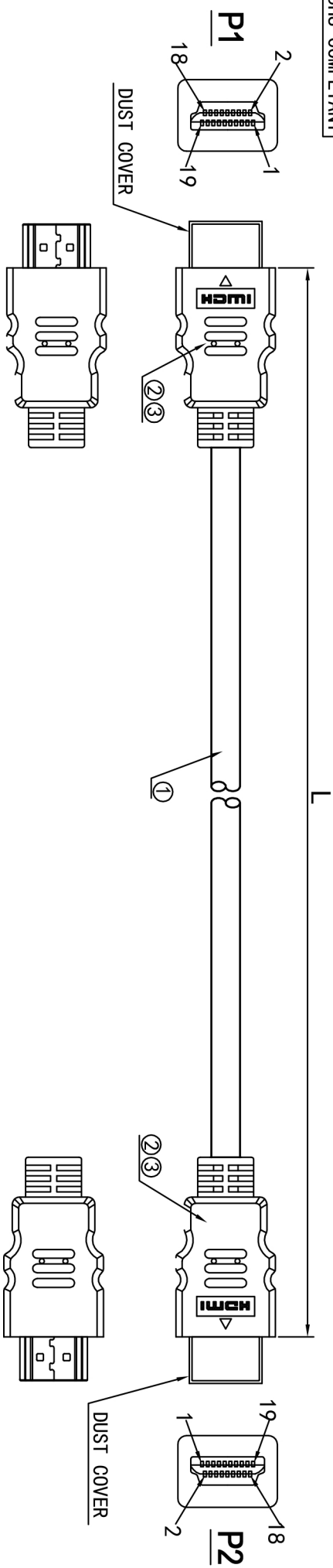

- NOTES:**
1. CABLE: JUL20276 (30AWG*1P+EAM) *5+30AWG*4C +AEB(CU WIRE, AM BRAID) OD=6.0MM JACKET: PVC BLACK; High Speed HDMI™ Cable with Ethernet
 2. CONN: HDMI A/M INSULATION: BLACK, SHELL NICKEL-PLATED;
 3. OUTER MOLD: PVC 45P BLACK;

ELECTRICAL TEST:

1. 100% TEST OPEN SHORT MIS-WIRE;
2. INSULATION RESISTANCE: 2M OHM MIN;

ITEM NO	L(MM)	T(MM)	HEAD SIZE	LABEL	INNER CTN	OUT CTN
11.04.5541	1000	+50/-0	205*166MM	LABEL1	10PCS/INNER CTN, (SIZE:17*12.5*23.5CM)	40PCS/OUT CTN (0.8:36*26.5*25CM)
11.04.5542	2000	+50/-0	205*166MM	LABEL2	10PCS/INNER CTN, (SIZE:21*15.8*20.5CM)	40PCS/OUT CTN (1.2:44*33*22CM)
11.04.5543	3000	+50/-0	205*166MM	LABEL3	10PCS/INNER CTN, (SIZE:21*15.8*20.5CM)	40PCS/OUT CTN (1.2:44*33*22CM)

WIRE ADDRESS

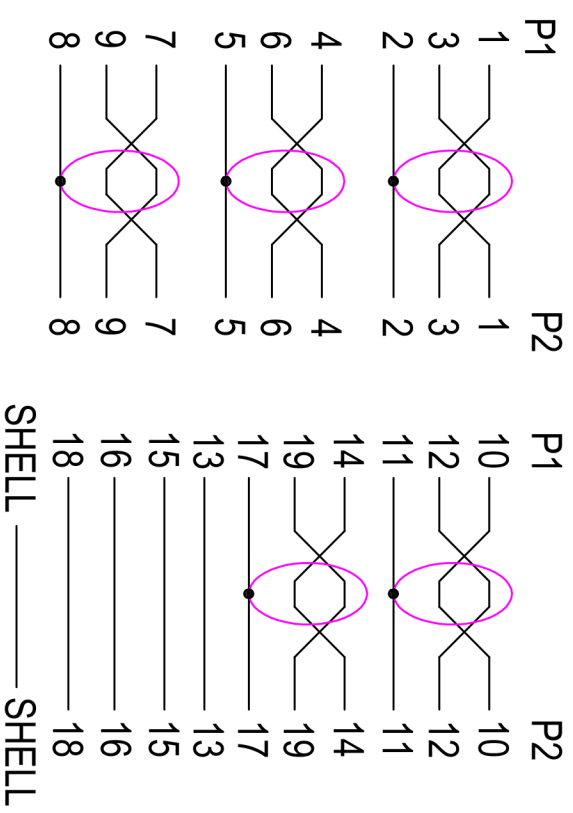

Company	Rotronic	Goods Code	Drawing Evidence:		Draw	F0038 ZYF	Date	2012-03-30	<p style="text-align: center;">Rotronic, Co., Ltd</p> <table border="1" style="width: 100%;"> <tr> <td>D</td> <td></td> </tr> <tr> <td>C</td> <td></td> </tr> <tr> <td>B</td> <td></td> </tr> <tr> <td>VER. A</td> <td>REVISE</td> </tr> </table>		D		C		B		VER. A	REVISE
D																		
C																		
B																		
VER. A	REVISE																	
ITEM NO	11.04.5543X				Check		Date											
Goods NO					Approval		Date											
Original NO.		Unit (MM)					Date											

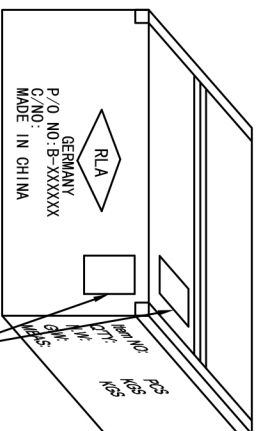
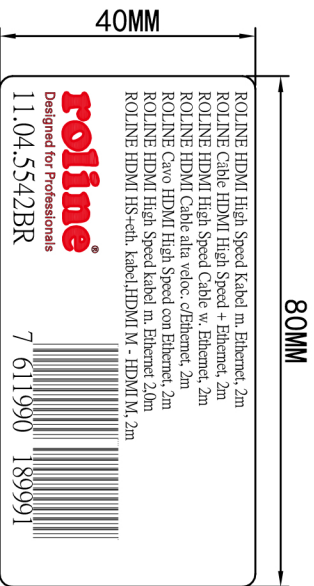

包装箱贴纸 (贴内箱)
 条码朝外 (客供)

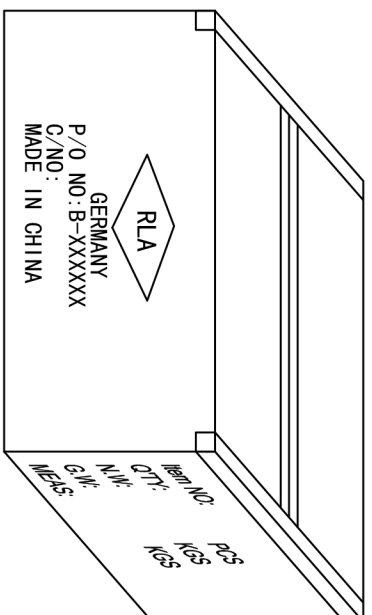

纸箱尺寸见第一张图画表格!

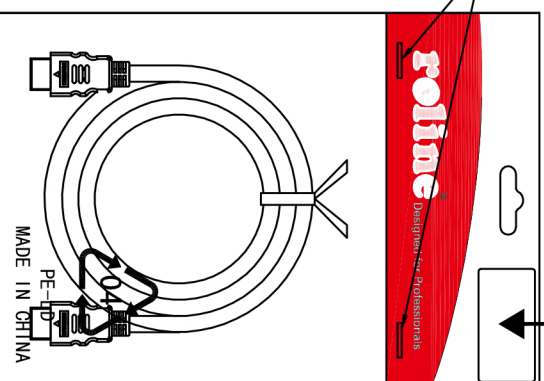
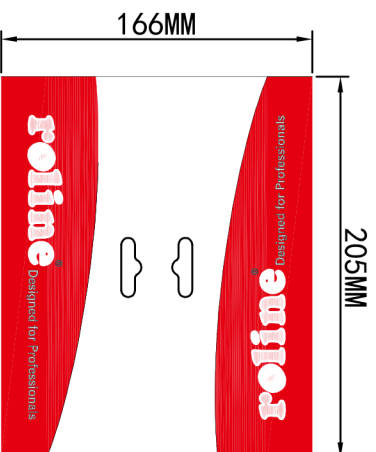

1PCS/PE BAG (200*300*0.06MM) +HEAD+STICKER
 +10PCS/ INNER CTN+40PCS/CTN

Company	Rotronic	Goods Code		Draw	FC038 ZYF	Date	2012-03-30	Rotronic, Co., Ltd	D	
ITEM NO	11.04.554X	Drawing Evidence:		Check		Date			C	
Goods NO		Unit (MM)		Approval		Date			B	
Original NO.								VER. A	REVISE	Date