

## Eccentric Quick Clamps · with screw

23390.0110



### Product Description

For quick and easy clamping and releasing of workpieces.  
When using the "adjustable" design (picture 2) the lever position can be moved.

### Material

#### Support washer

- Thermoplastic POM, glass-fiber reinforced

#### Lever

- Zinc die-cast, plastic coated, black

#### Inner parts

- Steel, zinc-plated by galvanization

#### Screw

- Steel, zinc-plated by galvanization

#### Adjusting nut

- Steel, zinc-plated by galvanization

### Drawing

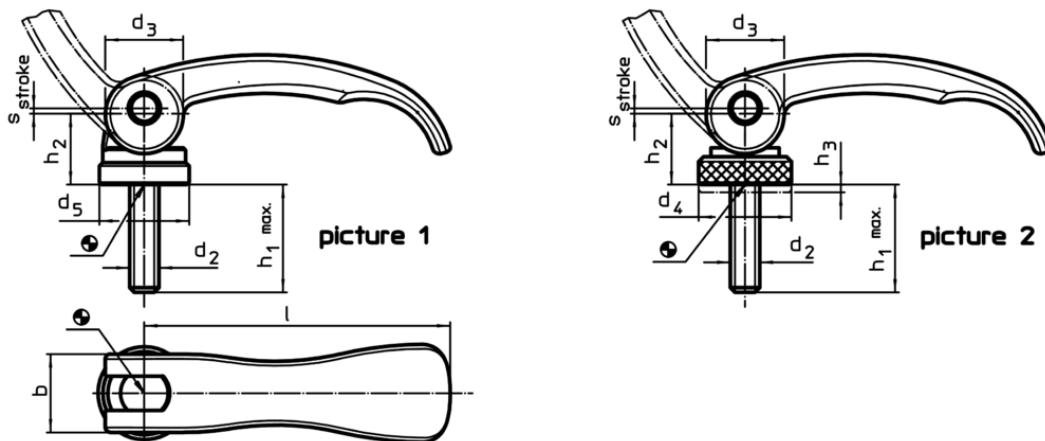

### Order information

l	d <sub>2</sub>	h <sub>1</sub> max. in clamping position	Dimensions				Regulating- range h <sub>3</sub> min.	b	Stroke s at 90° lever position [mm]	max. [°C]	[g]	Art. No.
			d <sub>3</sub>	d <sub>4</sub>	h <sub>2</sub> max.	[mm]						
with screw, adjustable – picture 2, steel												
63	M6	20	16	19	16.4	1.5	16	0.75	80	70	23390.0110	

## Application example

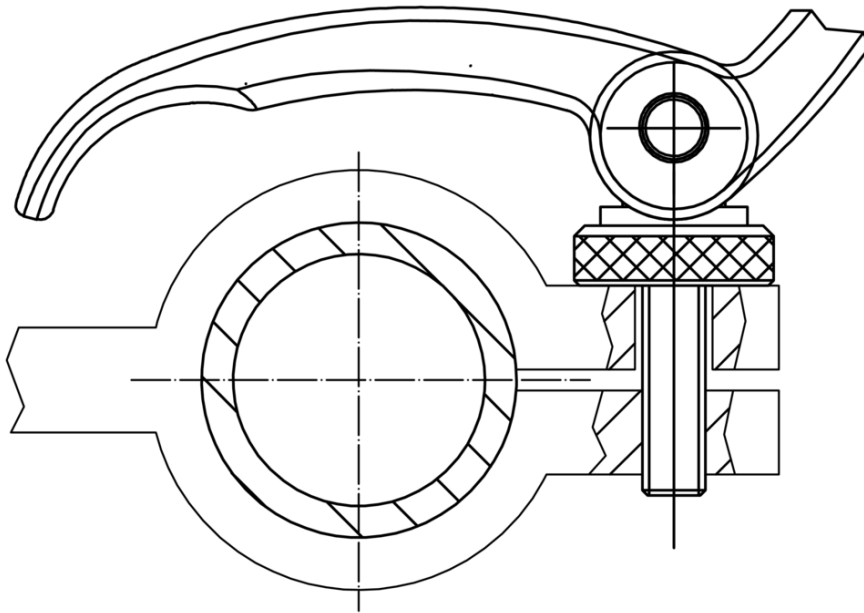

## Compliance

### RoHS compliant

Contains lead - compliant according to exceptions 6a / 6b / 6c

### Contains SVHC substances >0,1% w/w

Contains lead - SVHC list [REACH] as of 10.06.2022

### Contains Proposition 65 substances



Lead can cause cancer and reproductive harm from exposure  
<https://www.P65Warnings.ca.gov/>

### Free from Conflict Minerals

This product does not contain any substances designated as "conflict minerals" such as tantalum, tin, gold or tungsten from the Democratic Republic of Congo or adjacent countries.