

# WORLD-BEAM QS18U Ultrasonic Sensors



## Datasheet

Miniature ultrasonic sensors with TEACH-mode programming



- Fast, easy-to-use TEACH-Mode programming; no potentiometer adjustments
- Ultra-compact housing
- One discrete output: NPN or PNP, depending on model
- Two bi-colored status LEDs
- Rugged encapsulated version for harsh environments
- Choose 2 meter or 9 meter unterminated cable, 4-pin M12 or 4-pin M8 QD connectors (either integral or with 150 mm pigtail)
- Wide operating range of -20 °C to +60 °C (-4 °F to +140 °F)
- Temperature compensation
- Configurable for normally open or normally closed operation
- Fast response time (15 milliseconds)



### WARNING:

- Do not use this device for personnel protection
- Using this device for personnel protection could result in serious injury or death.
- This device does not include the self-checking redundant circuitry necessary to allow its use in personnel safety applications. A device failure or malfunction can cause either an energized (on) or de-energized (off) output condition.

## Models

| Models   | Sensing Range                   | TEACH Option   | Cable                                  | Supply Voltage     | Output |
|----------|---------------------------------|--|--|--------------------|--------|
| QS18UNA  | 50 mm to 500 mm (2 in to 20 in) | Integral push button or remote TEACH (IP67, NEMA 6P) | 4-wire, 2 m (6.5 ft) cable with shield | 12 V DC to 30 V DC | NPN    |
| QS18UPA  |                                 |  |  |                    | PNP    |
| QS18UNAE |                                 | Remote TEACH (epoxy-encapsulated, IP68, NEMA 6P)     |  |                    | NPN    |
| QS18UPAE |                                 |  |  |                    | PNP    |

Only standard 2 m (6.5 ft) cable models are listed. For 9 m (30 ft) shielded cable, add suffix "W/30" to the model number (e.g., QS18UNA W/30). A model with a QD connector requires a mating cordset. For QD models:

- To order the 4-pin integral M12 QD model, add the suffix **Q8** (for example, **QS18UNAQ8**).
- To order the 150 mm (6 in) cable with a 4-pin M12 QD model, add the suffix **Q5** (for example, **QS18UNAQ5**).
- To order the 4-pin integral M8 QD model, add the suffix **Q7** (for example, **QS18UNAQ7**).
- To order the 150 mm (6 in) cable with a 4-pin M8 QD model, add the suffix **Q** (for example, **QS18UNAQ**).

## Principles of Operation

Ultrasonic sensors emit one or multiple pulses of ultrasonic energy, which travel through the air at the speed of sound. A portion of this energy reflects off the target and travels back to the sensor. The sensor measures the total time required for the energy to reach the target and return to the sensor. The distance to the object is then calculated using the following formula:  $D = ct \div 2$

**D** = distance from the sensor to the target  
**c** = speed of sound in air  
**t** = transit time for the ultrasonic pulse

To improve accuracy, an ultrasonic sensor may average the results of several pulses before outputting a new value.

## Temperature Effects

The speed of sound is dependent upon the composition, pressure and temperature of the gas in which it is traveling. For most ultrasonic applications, the composition and pressure of the gas are relatively fixed, while the temperature may fluctuate.

In air, the speed of sound varies with temperature according to the following approximation:

In metric units:  $C_{m/s} = 20 \sqrt{273 + T_C}$

In English units:  $C_{ft/s} = 49 \sqrt{460 + T_F}$

$C_{m/s}$  = speed of sound in meters per second

$C_{ft/s}$  = speed of sound in feet per second

$T_C$  = temperature in °C

$T_F$  = temperature in °F

## Temperature Compensation

Changes in air temperature affect the speed of sound, which in turn affects the distance reading measured by the sensor. An increase in air temperature shifts both sensing window limits closer to the sensor. Conversely, a decrease in air temperature shifts both limits farther away from the sensor. This shift is approximately 3.5% of the limit distance for a 20° C change in temperature.



The QS18U series ultrasonic sensors are temperature compensated. This reduces the error due to temperature by about 90%. The sensor will maintain its window limits to within 1.8% over the -20° to +60° C (-4° to +140° F) range.

**Note:**

- Exposure to direct sunlight can affect the sensor’s ability to accurately compensate for changes in temperature.
- If the sensor is measuring across a temperature gradient, the compensation will be less effective.
- The temperature warmup drift upon power-up is less than 7% of the sensing distance. After 5 minutes, the apparent switchpoint will be within 0.6% of the actual position. After 25 minutes, the sensing position will be stable.

### Sensor Programming

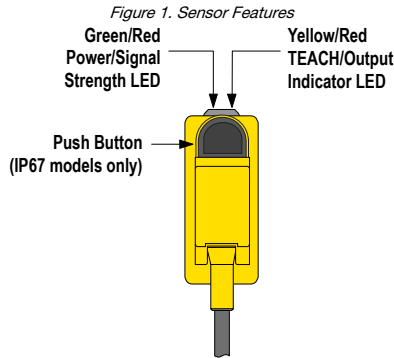

Two TEACH methods may be used to program the sensor:

- Teach individual minimum and maximum limits, or
- Use Auto-Window feature to center a sensing window around the taught position

The sensor may be programmed either via its push button, or via a remote switch. Remote programming also may be used to disable the push button, preventing unauthorized personnel from adjusting the programming settings. To access this feature, connect the white wire of the sensor to 0V dc, with a remote programming switch between the sensor and the voltage.

Programming is accomplished by following the sequence of input pulses (see [programming procedures](#)). The duration of each pulse (corresponding to a push button “click”), and the period between multiple pulses, are defined as “**T: 0.04 seconds < T < 0.8 seconds.**”

Figure 2. TEACH Interface

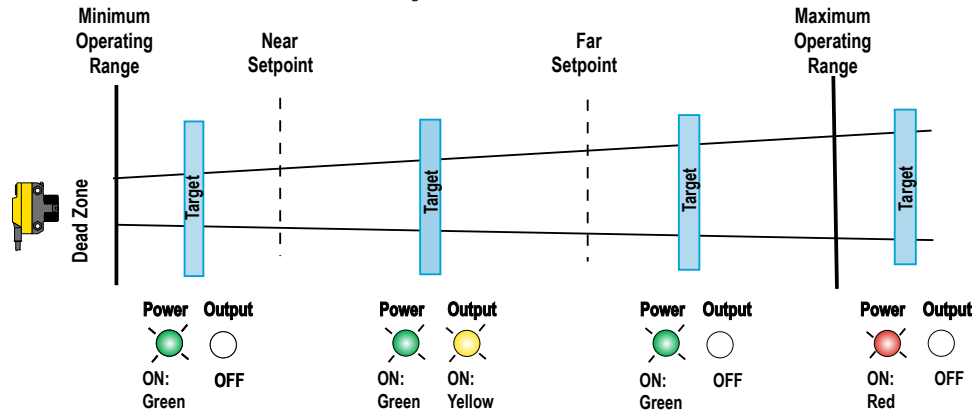

### Status Indicators

| Power ON/OFF LED | Indicates                                  | Output/Teach LED  | Indicates  |
|------------------|--|-------------------|--|
| OFF              | Power is OFF                               | OFF               | Target is outside window limits (normally open operation). |
| ON Red           | Target is weak or outside sensing range.   | Yellow            | Target is within window limits (normally open operation).  |
| ON Green         | Sensor is operating normally, good target. | ON Red (solid)    | In Teach Mode, waiting for first limit.                    |
|                  |  | ON Red (flashing) | In Teach Mode, waiting for second limit.                   |





### Teaching Minimum and Maximum Limits

**General Notes on Programming**

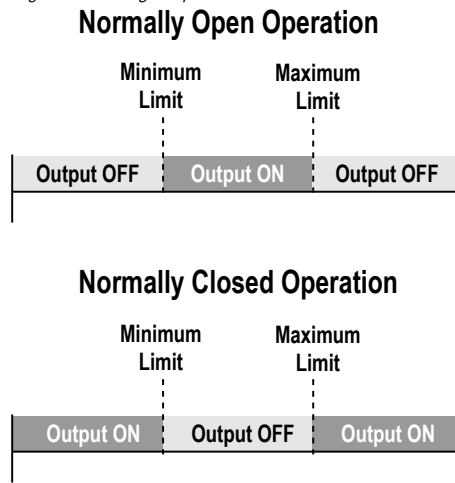
- The sensor returns to Run mode if the first TEACH condition is not registered within 120 seconds.
- After the first limit is taught, the sensor remains in Program mode until the TEACH sequence is finished.
- To exit Program mode without saving any changes, press and hold the programming push button for more than 2 seconds (before teaching the second limit). The sensor reverts to the last saved limits.

Figure 3. Teaching independent minimum and maximum limits

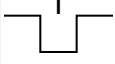

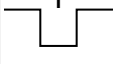
|                    | Procedure  |   | Result   |
|--------------------|--|---|--|
|                    | Push Button (0.04 sec ≤ Click ≤ 0.8 sec)   | Remote Line (0.04 sec < T < 0.8 sec)  |  |
| Programming Mode   | Press and hold push button<br>  | No action required; sensor is ready for 1st limit teach   | Output LED: ON Red<br>Power LED: ON Green (good signal) or ON Red (no signal)  |
| Teach First Limit  | Position the target for the first limit<br>Click the push button<br>    | Position the target for the first limit<br>Single-pulse the remote line<br>    | Power LED: Must be ON Green<br><b>Teach Accepted</b><br>Output LED: Flashing Red<br><b>Teach Unacceptable</b><br>Output LED: ON Red        |
| Teach Second Limit | Position the target for the second limit<br>Click the push button<br> | Position the target for the second limit<br>Single-pulse the remote line<br> | Power LED: Must be ON Green<br><b>Teach Accepted</b><br>Output LED: Yellow or OFF<br><b>Teach Unacceptable</b><br>Output LED: Flashing Red |

### Teaching Limits Using the Auto-Window Feature

Teaching the same limit twice automatically centers a 20 mm window on the taught position.

#### General Notes on Programming

- The sensor returns to Run mode if the first TEACH condition is not registered within 120 seconds.
- After the first limit is taught, the sensor remains in Program mode until the TEACH sequence is finished.
- To exit Program mode without saving any changes, press and hold the programming push button for more than 2 seconds (before teaching the second limit). The sensor reverts to the last saved program.

Figure 4. Using the Auto-Window feature for programming each output

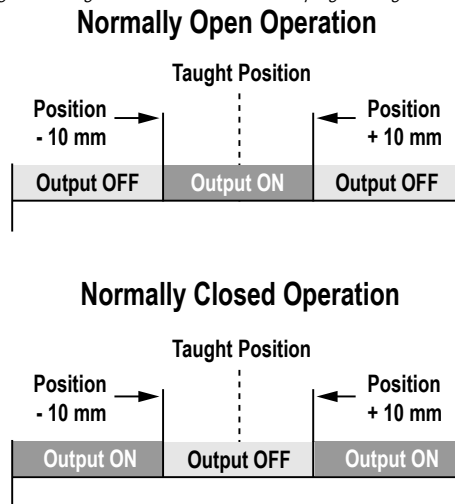





|                   | Procedure   |   | Result  |
|-------------------|---|---|---|
|                   | Push Button (0.04 sec ≤ Click ≤ 0.8 sec)  | Remote Line (0.04 sec < T < 0.8 sec)  |   |
| Programming Mode  | Press and hold push button<br>                                       | No action required; sensor is ready for 1st limit teach   | Output LED: ON Red<br>Power LED: ON Green (good signal) or ON Red (no signal)   |
| Teach First Limit | Position the target for the first limit<br>Click the push button<br> | Position the target for the center of the window<br>Single-pulse the remote line<br> | Power LED: Must be ON Green<br><b>Teach Accepted</b><br>Output LED: Flashing Red<br><b>Teach Unacceptable</b><br>Output LED: ON Red |
| Re-Teach Limit    | Without moving the target, click the push button again<br>           | Without moving the target, single-pulse the remote line again<br>                    | <b>Teach Accepted</b><br>Output LED: Yellow or OFF<br><b>Teach Unacceptable</b><br>Output LED: Flashing Red                         |

Figure 5. An application for the Auto-Window feature (retroreflective mode)

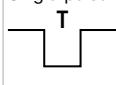

### Normally Open/Normally Closed Operation Select

Configure the sensor for either normally open or normally closed operation using the remote teach wire (white). A series of three pulses on the line toggles between normally open (NO) and normally closed (NC) operation. Normally open is defined as the output energizing when the target is present. Normally closed is defined as the output energizing when the target is absent. (See [Teaching Minimum and Maximum Limits](#) on p. 2 and [Teaching Limits Using the Auto-Window Feature](#) on p. 3.)

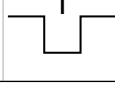
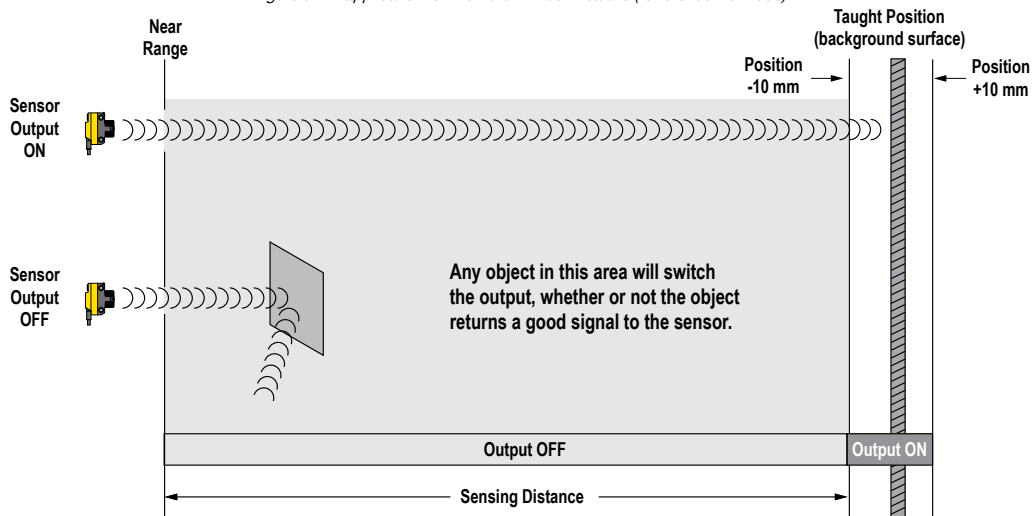
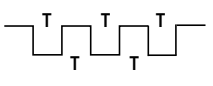
|                                | Procedure                                |   | Result   |
|--------------------------------|--|---|--|
|                                | Push Button (0.04 sec ≤ Click ≤ 0.8 sec) | Remote Line (0.04 sec < T < 0.8 sec)  |  |
| Toggle between NO/NC Operation | Not available via push button            | Triple-pulse the remote line<br> | Selects either Normally Open or Normally Closed operation depending on the previous condition. |

### Push Button Lockout

Enables or disables the push button to prevent unauthorized personnel from adjusting the program settings.

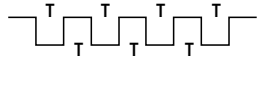
|                     | Procedure                                |  | Result   |
|---------------------|--|--|--|
|                     | Push Button (0.04 sec ≤ Click ≤ 0.8 sec) | Remote Line (0.04 sec < T < 0.8 sec)   |  |
| Push Button Lockout | Not available via push button            | Four-pulse the remote line<br> | Push buttons are either enabled or disabled, depending on condition. |

## Wiring Diagrams

Banner recommends connecting the shield wire to earth ground. Shielded cordsets are recommended for all QD models. Cabled wiring diagrams are shown. Quick disconnect wiring diagrams are functionally identical.

Figure 6. NPN (Sinking) Output Models

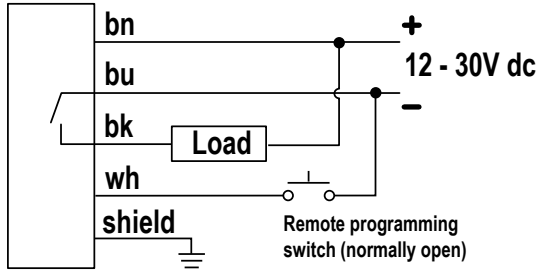
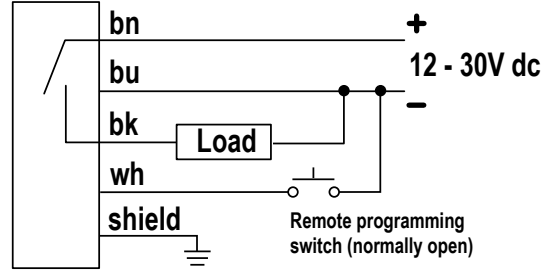

Figure 7. PNP (Sourcing) Output Models



## Specifications

### Sensing Range

50 to 500 mm (2 to 20 inches)

### Supply Voltage

12 V DC to 30 V DC (10% maximum ripple); 25 mA max (exclusive of load)

### Ultrasonic Frequency

300 kHz, rep. rate 7.5 ms

### Supply Protection Circuitry

Protected against reverse polarity and transient voltages

### Output Configuration

SPST solid-state switch conducts when target is sensed within sensing window; one NPN (current sinking) or one PNP (current sourcing), depending on model.

### Output Protection

Protected against short-circuit conditions

### Output Rating

Rating: 100 mA maximum load; see Application Note 1

Off-state leakage current: less than 10  $\mu$ A (sourcing); less than 200  $\mu$ A (sinking); see Application Note 2

ON-state saturation voltage: NPN: less than 1.6 V at 100 mA; PNP: less than 3.0 V at 100 mA

### Output Response

15 milliseconds

### Delay at Power Up

300 milliseconds

### Application Notes

If supply voltage is > 24 V DC, derate maximum output current 5 mA/°C above 50 °C. NPN off-state leakage current is < 200  $\mu$ A for load resistances > 3 k $\Omega$  or optically isolated loads. For load current of 100 mA, leakage is < 1% of load current. Objects passing inside the specified near limit may produce a false response.

### Environmental Rating

Leakproof design, rated NEMA 6P; IEC IP67 or IP68 depending on model; UL Type 1

### Operating Conditions

-20 °C to 60 °C (-4 °F to 140 °F)

100% relative humidity (non-condensing)

### Vibration and Mechanical Shock

All models meet MIL-STD-202F, Method 201A (Vibration: 10 Hz to 60 Hz maximum, 0.06 inch (1.52 mm) double amplitude, 10G maximum acceleration) requirements. Also meets IEC 60947-5-2 (Shock: 30G 11 ms duration, half sine wave) requirements.

### Certifications



### Repeatability

0.7 mm

### Minimum Window Size

5 mm

### Hysteresis

1.4 mm

### Adjustments

Sensing Window Limits: TEH-mode programming of near and far window limits may be set using the push button or remotely via TEH input

### Indicators

#### Range Indicator (Red/Green) and Teh/Output Indicator (Amber/Red)

Range Indicator: Green - Target is within sensing range; Red - Target is outside sensing range; OFF - Sensing Power is OFF

Teh/Output Indicator: Amber - Target is within taught limits; OFF - Target is outside taught window limits; Red - Sensor is in TEH mode

### Construction

ABS housing, TPE Push Button, ABS Push Button housing, Polycarbonate lightpipes

### Connections

2 m (6.5 ft) or 9 m (30 ft) 4-conductor PVC jacketed cable, or 4-pin Euro-style integral QD (Q8), or 4-pin Pico-style integral QD (Q7), or 4-pin Euro-style 150 mm (6 in) pigtail QD (Q5), or 4-pin Pico-style 150 mm (6 in) pigtail QD (Q)

### Temperature Warmup Drift

See [Temperature Compensation](#) on p. 1

### Temperature Effect

Non-encapsulated models:  $\pm 0.05\%$  per °C from -20 to 50 °C,  $\pm 0.1\%$  per °C from 50 to 60 °C

Encapsulated models:  $\pm 0.05\%$  per °C from 0 to 60 °C,  $\pm 0.1\%$  per °C from -20 to 0 °C

### Required Overcurrent Protection



**WARNING:** Electrical connections must be made by qualified personnel in accordance with local and national electrical codes and regulations.

Overcurrent protection is required to be provided by end product application per the supplied table.

Overcurrent protection may be provided with external fusing or via Current Limiting, Class 2 Power Supply.

Supply wiring leads < 24 AWG shall not be spliced.

For additional product support, go to [www.bannerengineering.com](http://www.bannerengineering.com).

| Supply Wiring (AWG) | Required Overcurrent Protection (Amps) |
|---------------------|--|
| 20                  | 5.0                                    |
| 22                  | 3.0                                    |
| 24                  | 2.0                                    |
| 26                  | 1.0                                    |
| 28                  | 0.8                                    |
| 30                  | 0.5                                    |

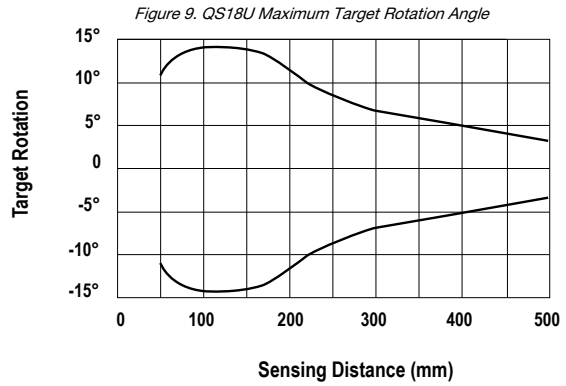
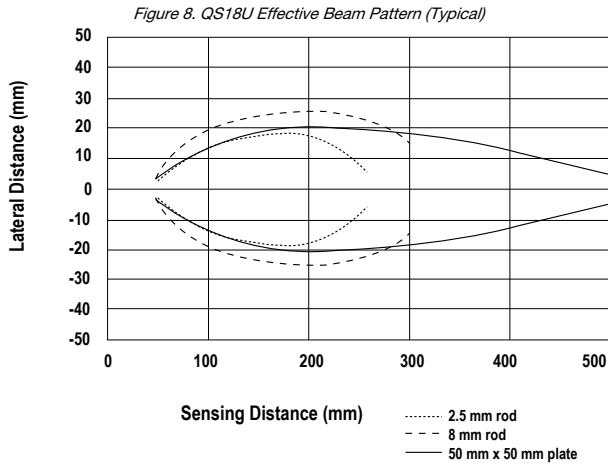

## Dimensions

All measurements are listed in millimeters, unless noted otherwise.

**Figure 10. Cabled models**

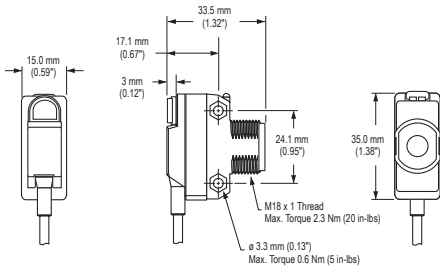

**Figure 11. M8 QD models**

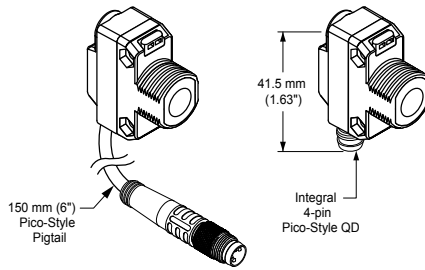

**Figure 12. M12 QD models**

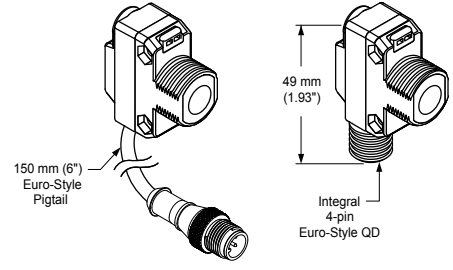

**Figure 13. Locknut (included with all models)**

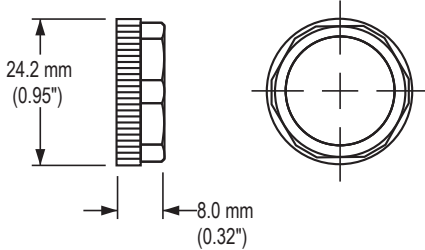

**Figure 14. Washer (included with all models)**

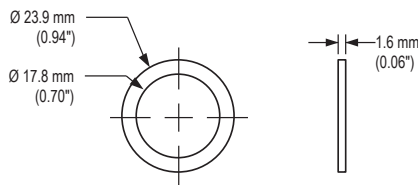

### M3 Hardware Packet Contents

- 2 – M3 x 0.5 x 20 mm SS Screw
- 2 – M3 x 0.5 SS Hex Nut
- 2 – M3 SS Washer

## Accessories

### Quick-Disconnect (QD) Cordsets

| 4-Pin Snap-On M8 Cordsets with Shield—Single Ended |               |          |            |                 |   |
|--|---------------|----------|------------|-----------------|---|
| Model  | Length        | Style    | Dimensions | Pinout (Female) |   |
| PKG4S-2  | 2 m (6.56 ft) | Straight |            |                 | 1 = Brown<br>2 = White<br>3 = Blue<br>4 = Black |

| 4-Pin Snap-On M8 Cordsets with Shield—Single Ended |               |             |            |                 |
|--|---------------|-------------|------------|-----------------|
| Model  | Length        | Style       | Dimensions | Pinout (Female) |
| PKW4ZS-2   | 2 m (6.56 ft) | Right Angle |            |                 |

| 4-Pin Threaded M12 Cordsets with Shield—Single Ended |               |             |            |                 |
|--|---------------|-------------|------------|-----------------|
| Model  | Length        | Style       | Dimensions | Pinout (Female) |
| MQDEC2-406   | 2 m (6.56 ft) | Straight    |            |                 |
| MQDEC2-415   | 5 m (16.4 ft) |             |            |                 |
| MQDEC2-430   | 9 m (29.5 ft) |             |            |                 |
| MQDEC2-406RA   | 2 m (6.56 ft) | Right-Angle |            |                 |
| MQDEC2-415RA   | 5 m (16.4 ft) |             |            |                 |
| MQDEC2-430RA   | 9 m (29.5 ft) |             |            |                 |

- 1 = Brown
- 2 = White
- 3 = Blue
- 4 = Black

## Mounting Brackets

All measurements are listed in millimeters, unless noted otherwise.

### SMB18A

- Right-angle mounting bracket with a curved slot for versatile orientation
- 12-ga. stainless steel
- 18 mm sensor mounting hole
- Clearance for M4 (#8) hardware

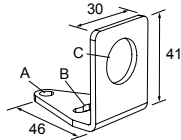

**Hole center spacing:** A to B = 24.2  
**Hole size:** A =  $\phi$  4.6, B = 17.0 x 4.6, C =  $\phi$  18.5

### SMBQS18RA

- Right-angle mounting bracket
- 14-ga. 304 stainless steel

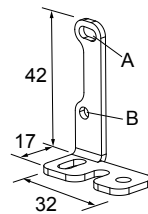

**Hole center spacing:** A to B = 20.3  
**Hole size:** A = 4.3 x 9.3, B =  $\phi$  4.3

### SMB18SF

- 18 mm swivel bracket with M18 x 1 internal thread
- Black thermoplastic polyester
- Stainless steel swivel locking hardware included

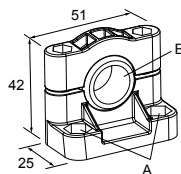

**Hole center spacing:** A = 36.0  
**Hole size:** A =  $\phi$  5.3, B =  $\phi$  18.0

### SMB18UR

- 2-piece universal swivel bracket
- 300 series stainless steel
- Stainless steel swivel locking hardware included
- Mounting hole for 18 mm sensor

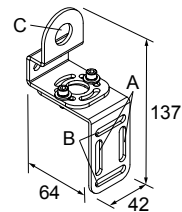

**Hole center spacing:** A = 25.4, B = 46.7  
**Hole size:** B = 6.9 x 32.0, C =  $\phi$  18.3

## Banner Engineering Corp. Limited Warranty

---

Banner Engineering Corp. warrants its products to be free from defects in material and workmanship for one year following the date of shipment. Banner Engineering Corp. will repair or replace, free of charge, any product of its manufacture which, at the time it is returned to the factory, is found to have been defective during the warranty period. This warranty does not cover damage or liability for misuse, abuse, or the improper application or installation of the Banner product.

**THIS LIMITED WARRANTY IS EXCLUSIVE AND IN LIEU OF ALL OTHER WARRANTIES WHETHER EXPRESS OR IMPLIED (INCLUDING, WITHOUT LIMITATION, ANY WARRANTY OF MERCHANTABILITY OR FITNESS FOR A PARTICULAR PURPOSE), AND WHETHER ARISING UNDER COURSE OF PERFORMANCE, COURSE OF DEALING OR TRADE USAGE.**

This Warranty is exclusive and limited to repair or, at the discretion of Banner Engineering Corp., replacement. **IN NO EVENT SHALL BANNER ENGINEERING CORP. BE LIABLE TO BUYER OR ANY OTHER PERSON OR ENTITY FOR ANY EXTRA COSTS, EXPENSES, LOSSES, LOSS OF PROFITS, OR ANY INCIDENTAL, CONSEQUENTIAL OR SPECIAL DAMAGES RESULTING FROM ANY PRODUCT DEFECT OR FROM THE USE OR INABILITY TO USE THE PRODUCT, WHETHER ARISING IN CONTRACT OR WARRANTY, STATUTE, TORT, STRICT LIABILITY, NEGLIGENCE, OR OTHERWISE.**

Banner Engineering Corp. reserves the right to change, modify or improve the design of the product without assuming any obligations or liabilities relating to any product previously manufactured by Banner Engineering Corp. Any misuse, abuse, or improper application or installation of this product or use of the product for personal protection applications when the product is identified as not intended for such purposes will void the product warranty. Any modifications to this product without prior express approval by Banner Engineering Corp will void the product warranties. All specifications published in this document are subject to change; Banner reserves the right to modify product specifications or update documentation at any time. Specifications and product information in English supersede that which is provided in any other language. For the most recent version of any documentation, refer to: [www.bannerengineering.com](http://www.bannerengineering.com).

For patent information, see [www.bannerengineering.com/patents](http://www.bannerengineering.com/patents).