

Single Locking Cable Tie

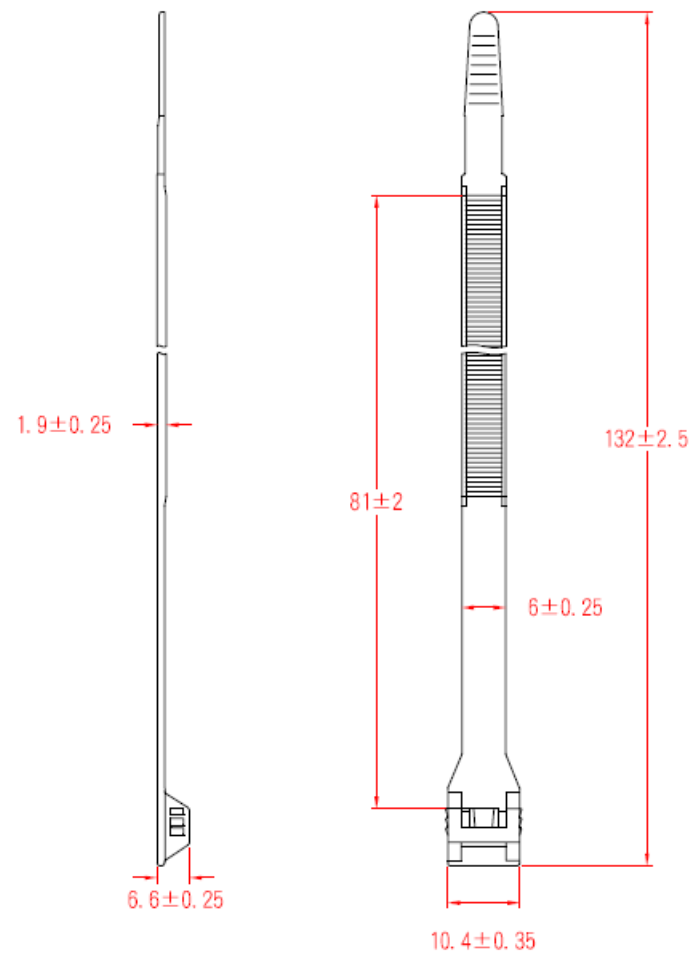

Material: UL 94V-2, Nylon 66

Length: 132 mm

Wide: 6 mm

Max. Bundle Dia.: 25 mm

Min. Loop Tensile Strength: 22 kgs