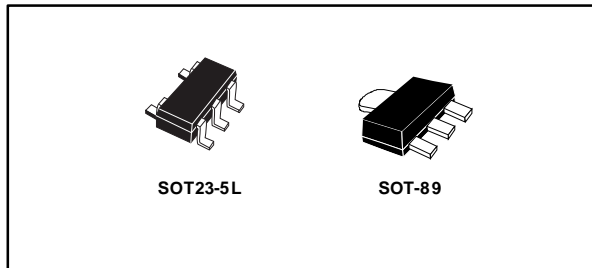

200 mA high accuracy and high PSRR voltage regulator

Datasheet - production data

**Applications**

- DSC
- TV
- BD, DVD
- PC
- Industrial

Description

The LDK320 is a low drop voltage regulator, which provides a maximum output current of 200 mA from an input voltage in the range of 2.5 V to 18 V, with a typical dropout voltage of 100 mV.

It is stabilized with a ceramic capacitor on the output.

The very good dynamic characteristic, combined with low drop voltage and low quiescent current make it suitable for low power battery-powered applications.

The enable logic control function allows the LDK320 to be in shutdown mode by consuming a total current lower than 1 μ A.

This device also includes a short-circuit current limiting, thermal and SOA protections.

Features

- Input voltage from 2.5 to 18 V
- Very low-dropout voltage (100 mV typ. @ 100 mA load)
- Low quiescent current (typ. 60 μ A, 1 μ A in off mode)
- High PSRR: 88 dB@120 Hz
- Low noise
- Output voltage tolerance: $\pm 0.5\%$ @ 25 $^{\circ}$ C (LDK320A) or $\pm 2\%$ 25 $^{\circ}$ C
- Output current up to 200 mA
- Wide range of output voltages available on request: fixed from 1.2 V to 12 V with 100 mV step and adjustable
- Logic-controlled electronic shutdown
- Compatible with ceramic capacitor
 $C_{OUT} = 1 \mu$ F
- Current, SOA and thermal protections
- Available in SOT23-5L and SOT-89 packages
- Temperature range: -40 $^{\circ}$ C to 125 $^{\circ}$ C

Contents

1 Diagram..... 3

2 Pin configuration 4

3 Typical application 5

4 Maximum ratings 6

5 Electrical characteristics 7

6 Typical characteristics 10

7 Package information 16

 7.1 SOT23-5L package information 16

 7.2 SOT23-5L packing information..... 18

 7.3 SOT-89 package information 19

 7.4 SOT-89 packing information..... 22

8 Ordering information..... 23

9 Revision history 24

1 Diagram

Figure 1: Block diagram (fixed version)

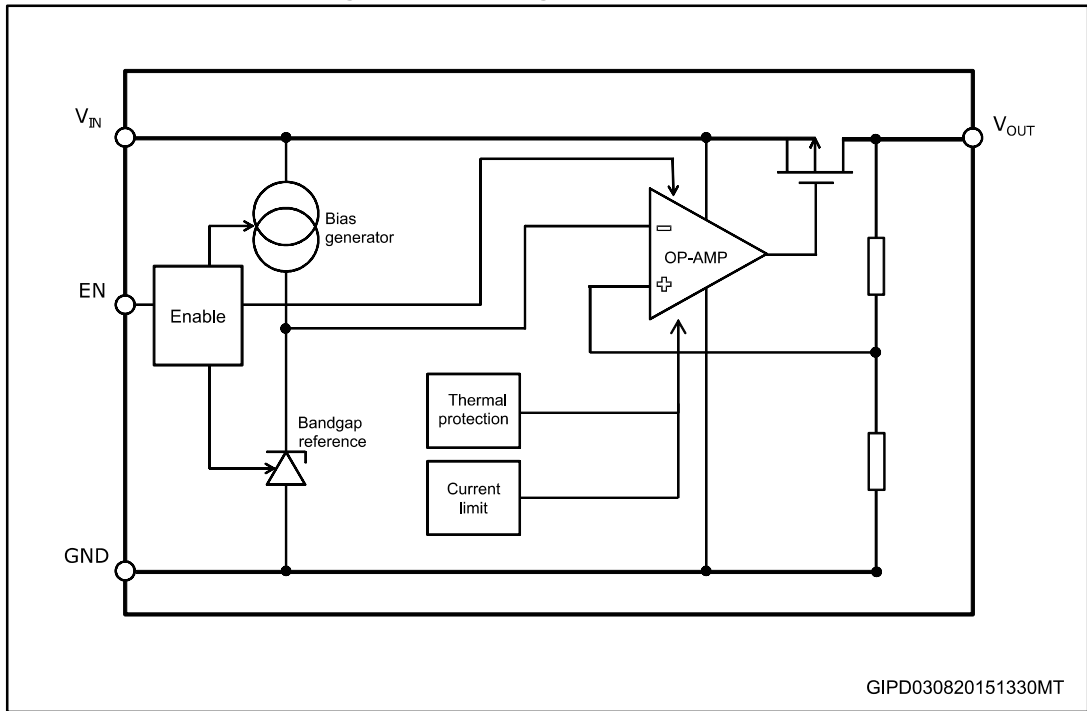
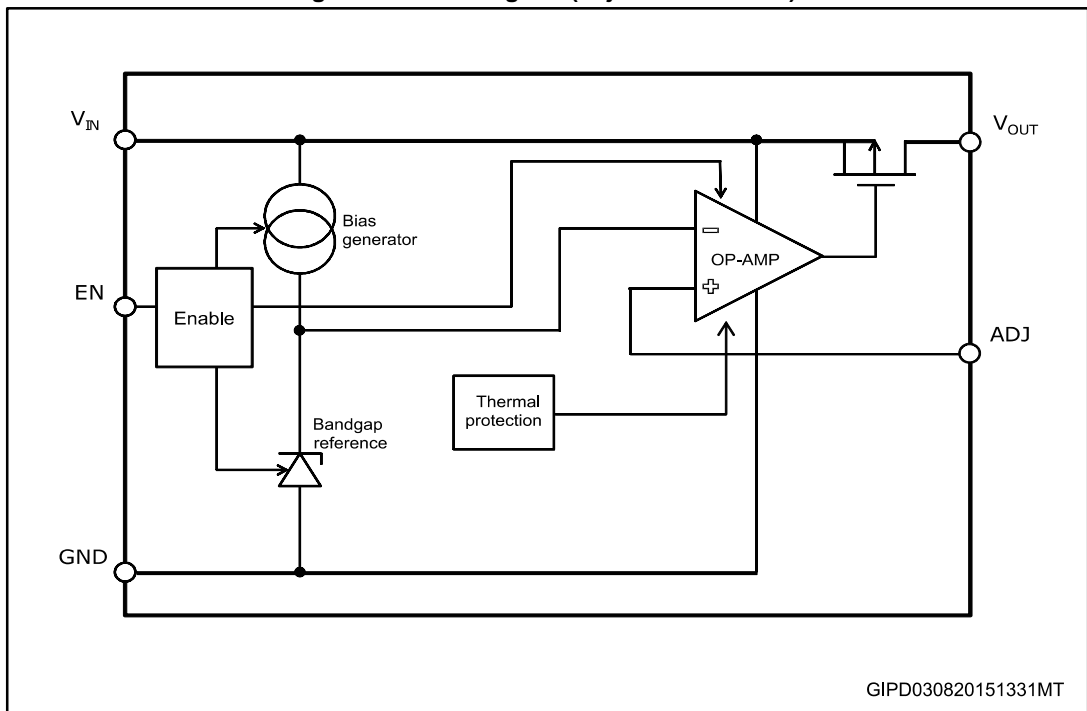

Figure 2: Block diagram (adjustable version)



2 Pin configuration

Figure 3: Pin connection (top view)

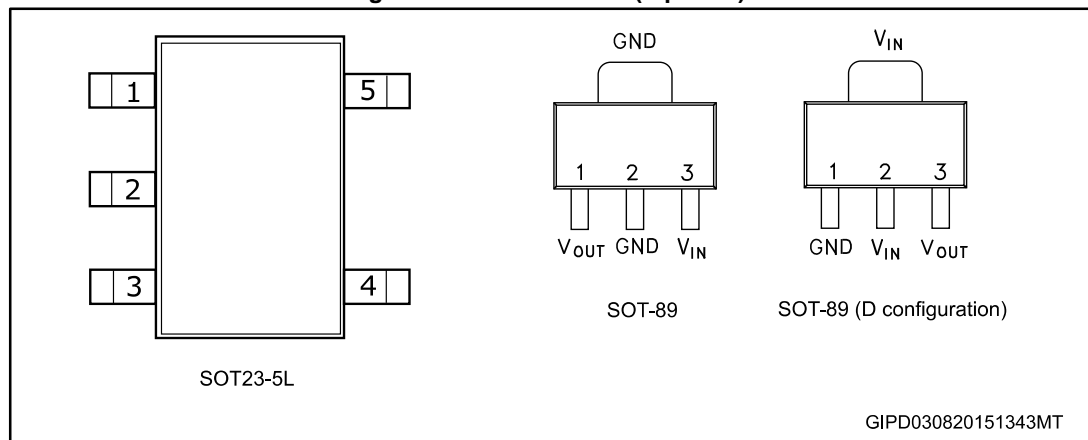

Table 1: Pin description (SOT23-5L)

Pin n°	Symbol	Function
1	IN	Input voltage of the LDO
2	GND	Common ground
3	EN	Enable pin logic input: low = shutdown, high = active
4	ADJ/NC	Adjustable pin on ADJ version, not connected on fixed version
5	OUT	Output voltage of the LDO

Table 2: Pin description (SOT-89)

Pin n°	Symbol	Function
1	OUT	Output voltage of the LDO
2	GND	Common ground
3	IN	Input voltage of the LDO
TAB	GND	Common ground

Table 3: Pin description (SOT-89, D configuration)

Pin n°	Symbol	Function
1	GND	Common ground
2	IN	Input voltage of the LDO
3	OUT	Output voltage of the LDO
TAB	IN	Input voltage of the LDO

3 Typical application

Figure 4: Typical application circuits

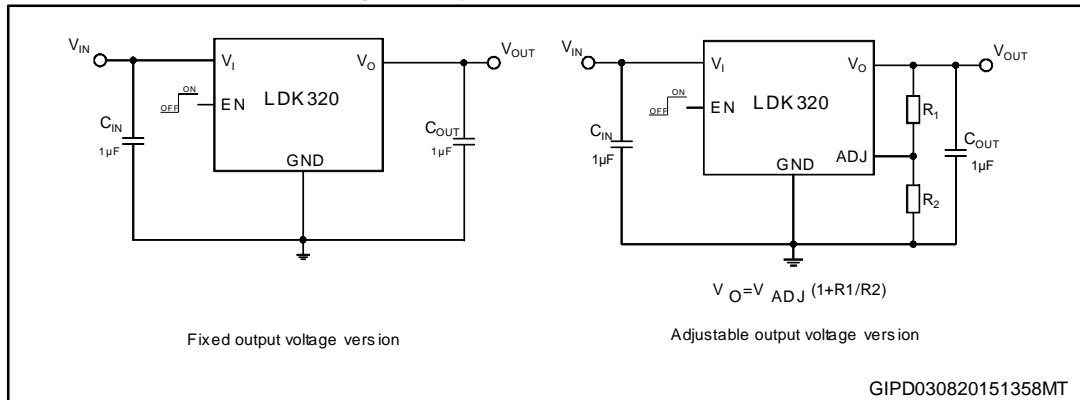

Adjustable version and enable pin are not available on SOT-89 package.

4 Maximum ratings

Table 4: Absolute maximum ratings

Symbol	Parameter	Value	Unit
V_{IN}	DC input voltage	- 0.3 to 20	V
V_{OUT}	DC output voltage	- 0.3 to $V_I + 0.3$	V
V_{EN}	Enable input voltage	- 0.3 to $V_I + 0.3$	V
V_{ADJ}	ADJ pin voltage	- 0.3 to 2	V
I_{OUT}	Output current	Internally limited	mA
$P_D^{(1)}$	Power dissipation	Internally limited	mW
T_{STG}	Storage temperature range	- 65 to 150	°C
T_{OP}	Operating junction temperature range	- 40 to 125	°C

Notes:

⁽¹⁾Maximum power dissipation must be calculated by taking into account the package and thermal performance.



Absolute maximum ratings are those values beyond which damage to the device may occur. Functional operation under these conditions is not implied. All values are referred to GND.

Table 5: Thermal data

Symbol	Parameter	SOT23-5L	SOT-89	Unit
R_{thJA}	Thermal resistance junction-ambient	160	110	°C/W
R_{thJC}	Thermal resistance junction-case	68	15	°C/W

5 Electrical characteristics

$T_J = 25\text{ °C}$, $V_{IN} = V_{OUT(NOM)} + 1\text{ V}$, $C_{IN} = C_{OUT} = 1\text{ }\mu\text{F}$, $I_{OUT} = 1\text{ mA}$, $V_{EN} = V_{IN}$, unless otherwise specified.

Table 6: LDK320 electrical characteristics (fixed output version)

Symbol	Parameter	Test conditions	Min.	Typ.	Max.	Unit
V_{IN}	Operating input voltage		2.5		18	V
V_{OUT}	V_{OUT} accuracy	$T_J = 25\text{ °C}$	-2		2	%
		$-40\text{ °C} < T_J < 125\text{ °C}$	-3		3	%
	V_{OUT} accuracy, LDK320A	$T_J = 25\text{ °C}$	-0.5		0.5	%
		$-40\text{ °C} < T_J < 125\text{ °C}$	-1.5		1.5	%
V_{OUT}	Static line regulation	$V_{OUT} + 1\text{ V}$ $V_{IN} 18\text{ V}$		0.001	0.05	%/V
V_{OUT}	Static load regulation	$I_{OUT} = 1\text{ mA}$ to 200 mA		0.001	0.003	%/mA
V_{DROP}	Dropout voltage ⁽¹⁾	$I_{OUT} = 100\text{ mA}$, $V_{OUT} = 3.3\text{ V}$		100		
		$I_{OUT} = 200\text{ mA}$, $V = 3.3\text{ V}$ $40\text{ °C} < T_J < 125\text{ °C}$		200	350	mV
e_N	Output noise voltage	10 Hz to 100 kHz $I_{OUT} = 10\text{ mA}$		63		$\mu\text{V}_{RMS}/\text{V}$
SVR	Supply voltage rejection	$f = 120\text{ Hz}$, $I_{OUT} = 10\text{ mA}$ $V_{OUT} = 3.3\text{ V}$		88		dB
		$f = 1\text{ kHz}$ $I_{OUT} = 10\text{ mA}$ $V_{OUT} = 3.3\text{ V}$		65		
		$f = 10\text{ kHz}$, $I_{OUT} = 10\text{ mA}$ $V_{OUT} = 3.3\text{ V}$		48		
I_Q	Quiescent current	$V_{OUT} + 1\text{ V}$ $V_{IN} 18\text{ V}$ $I_{OUT} = 0\text{ mA}$, $-40\text{ °C} < T_J < 125\text{ °C}$		60	90	μA
		$V_{IN} = V_{OUT} + 1\text{ V}$ $I_{OUT} = 200\text{ mA}$, $-40\text{ °C} < T_J < 125\text{ °C}$		70	100	
		V_{IN} input current in OFF mode: $V_{EN} = G_{ND}$ $T_J = 25\text{ °C}$		0.2	1	
I_{SC}	Short-circuit current	$R_L = 0$		330		mA
		$R_L = 0$, $V_{IN} = 16\text{ V}$		200		

Symbol	Parameter	Test conditions	Min.	Typ.	Max.	Unit
V _{EN}	Enable input logic low	V _{IN} = 2.5 V to 18 V -40 °C < T _J < 125 °C			0.4	V
	Enable input logic high	V _{IN} = 2.5 V to 18 V -40 °C < T _J < 125 °C	1.2			
I _{EN}	Enable pin input current	V _{EN} = V _{IN}		0.1	100	nA
T _{SHDN}	Thermal shutdown			160		°C
	Hysteresis			20		
C _{OUT}	Output capacitor	Capacitance (see Section 6: "Typical characteristics")	1		22	µF

Notes:

⁽¹⁾Dropout voltage is the input-to-output voltage difference at which the output voltage is 100 mV below its nominal value.

T_J = 25 °C, V_{IN} = 2.5 V, C_{IN} = C_{OUT} = 1 µF, I_{OUT} = 1 mA, V_{EN} = V_{IN}, unless otherwise specified.

Table 7: LDK320 electrical characteristics (ADJ version)

Symbol	Parameter	Test conditions	Min.	Typ.	Max.	Unit
V _{IN}	Operating input voltage		2.5		18	V
V _{ADJ}	Adjustable voltage	T _J = 25 °C		1.185		V
	Adjustable voltage accuracy	T _J = 25 °C	-2		+2	%
		40 °C < T _J < 125 °C	-3		+3	
	Adjustable voltage, LDK320A	T _J = 25 °C		1.2		V
Adjustable voltage accuracy, LDK320A	T _J = 25 °C	-0.5		+0.5	%	
	40 °C < T _J < 125 °C	-1.5		+1.5		
ΔV _{OUT}	Static line regulation	V _{OUT} + 1 V ≤ V _{IN} ≤ 18 V		0.001	0.05	%/V
ΔV _{OUT}	Static load regulation	I _{OUT} = 1 mA to 200 mA		0.0002	0.003	%/mA
V _{DROP}	Dropout voltage ⁽¹⁾	I _{OUT} = 100 mA V _{OUT} = 3.3 V		100		mV
		I _{OUT} = 200 mA V _{OUT} = 3.3 V 40 °C < T _J < 125 °C		200	350	
e _N	Output noise voltage	10 Hz to 100 kHz I _{OUT} = 10 mA		60		µV _{RMS}
I _{ADJ}	Adjust pin current				1	µA

Symbol	Parameter	Test conditions	Min.	Typ.	Max.	Unit
SVR	Supply voltage rejection	f = 120 Hz I _{OUT} = 10 mA, V _{OUT} = V _{ADJ}		83		dB
		f = 1 kHz I _{OUT} = 10 mA V _{OUT} = V _{ADJ}		73		
		f = 10 kHz I _{OUT} = 10 mA V _{OUT} = V _{ADJ}		58		
I _Q	Quiescent current	V _{OUT} + 1 V ≤ V _{IN} ≤ 18 V I _{OUT} = 0 mA -40 °C < T _J < 125 °C		50	90	μA
		V _{IN} = V _{OUT} + 1 V I _{OUT} = 200 mA -40 °C < T _J < 125 °C		60	100	
		V _{IN} input current in OFF mode: V _{EN} = GND T _J = 25 °C		0.2	1	
I _{SC}	Short-circuit current	R _L = 0		330		mA
		R _L = 0, V _{IN} = 16 V		200		
V _{EN}	Enable input logic low	V _{IN} = 2.5 V to 18 V -40 °C < T _J < 125 °C			0.4	V
	Enable input logic high	V _{IN} = 2.5 V to 18 V -40 °C < T _J < 125 °C	1.2			
I _{EN}	Enable pin input current	V _{EN} = V _{IN}		0.1	100	nA
T _{SHDN}	Thermal shutdown			160		°C
	Hysteresis			20		
C _{OUT}	Output capacitor	Capacitance (see Section 6: "Typical characteristics")	1		22	μF

6 Typical characteristics

Unless otherwise specified: $T_J = 25\text{ }^\circ\text{C}$, $V_{IN} = V_{OUT(NOM)} + 1\text{ V}$, $C_{IN} = C_{OUT} = 1\text{ }\mu\text{F}$.

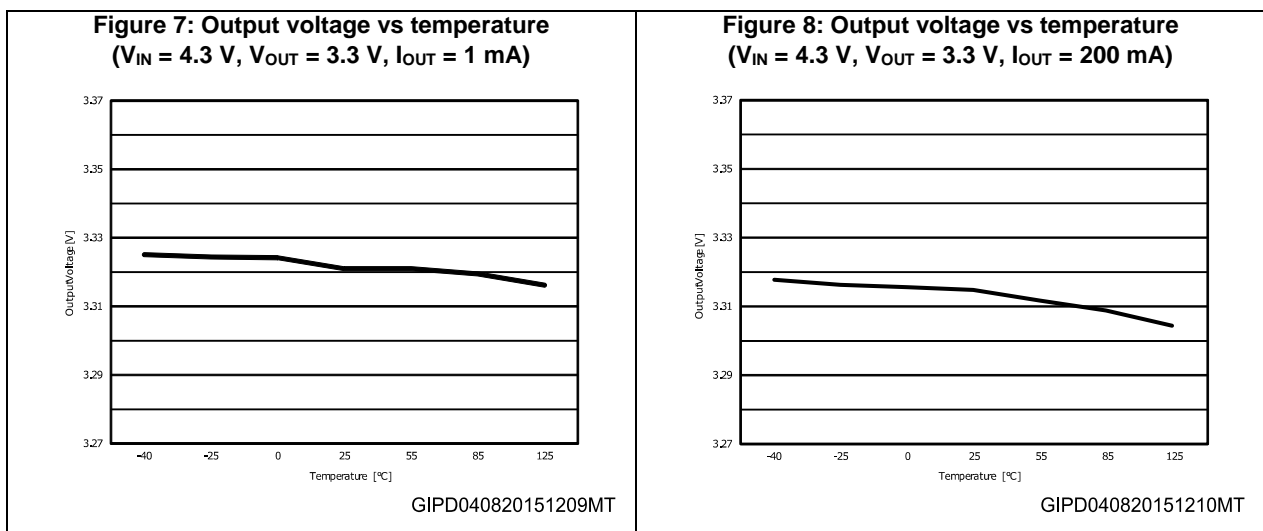
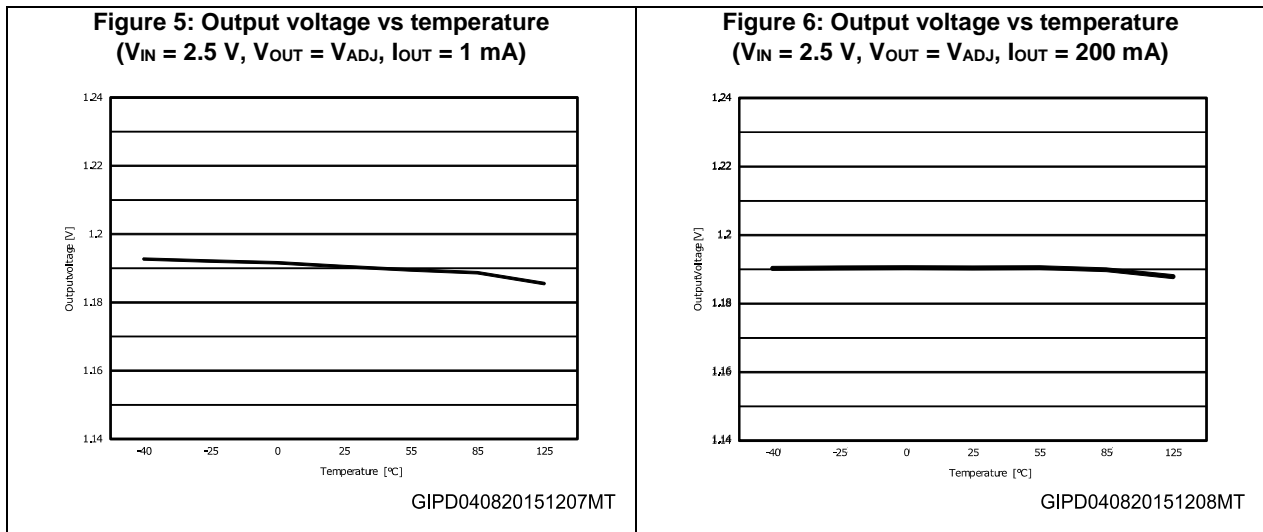
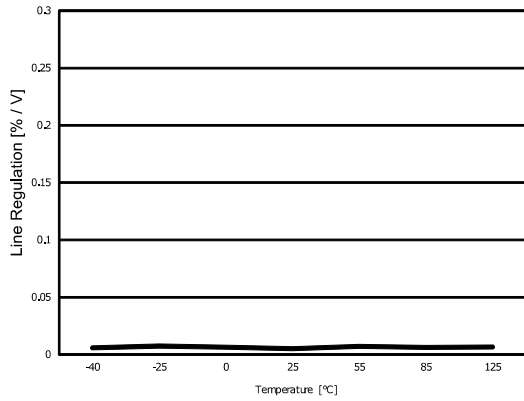
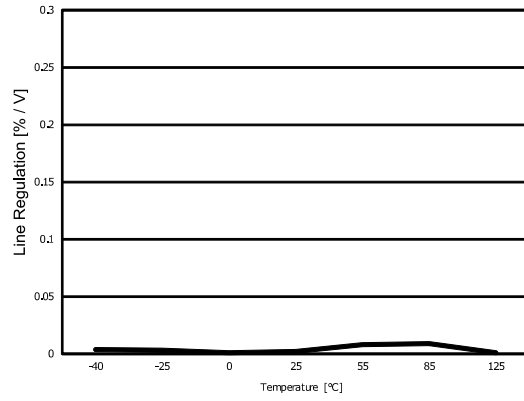

Figure 9: Line regulation vs temperature
 ($V_{IN} = 4.3 \text{ V}$, $V_{OUT} = 3.3 \text{ V}$, $I_{OUT} = 1 \text{ mA}$)



GIPD040820151211MT

Figure 10: Line regulation vs temperature
 ($V_{IN} = 2.5 \text{ to } 18 \text{ V}$, $V_{OUT} = V_{ADJ}$, $I_{OUT} = 1 \text{ mA}$)



GIPD040820151212MT

Figure 11: Load regulation vs temperature
 ($V_{IN} = 4.3 \text{ V}$, $V_{OUT} = 3.3 \text{ V}$, $I_{OUT} = 1 \text{ to } 200 \text{ mA}$)

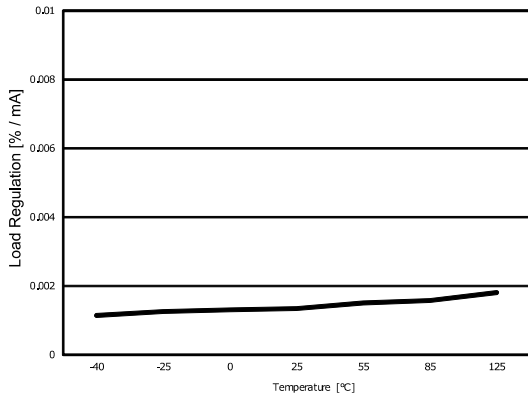

GIPD040820151213MT

Figure 12: Load regulation vs temperature
 ($V_{IN} = 2.5 \text{ V}$, $V_{OUT} = V_{ADJ}$, $I_{OUT} = 1 \text{ to } 200 \text{ mA}$)

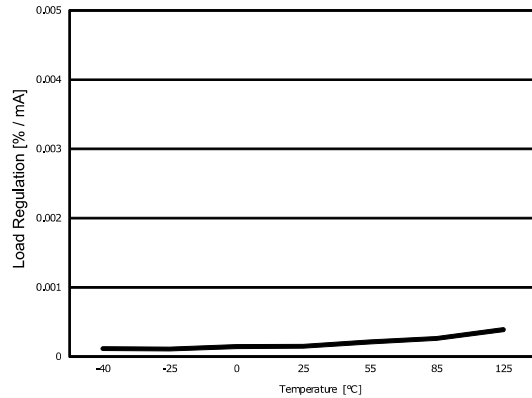

GIPD040820151214MT

Figure 13: Enable thresholds vs temperature
 ($I_{OUT} = 1 \text{ mA}$)

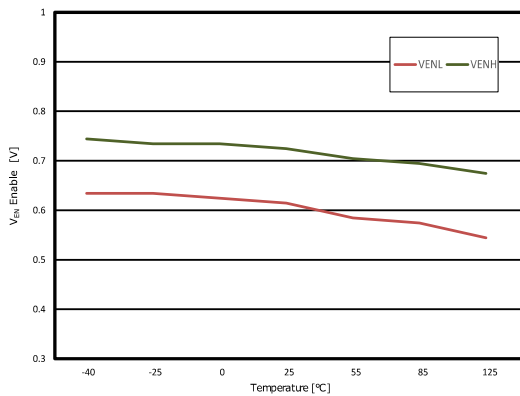

GIPD040820151215MT

Figure 14: Dropout voltage vs temperature

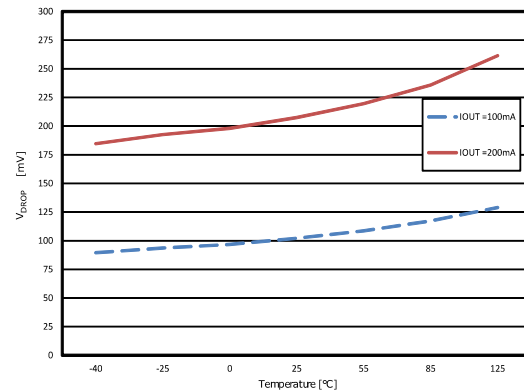

GIPD040820151216MT

Figure 15: Quiescent current vs input voltage
($I_{OUT} = 1\text{ mA}$)

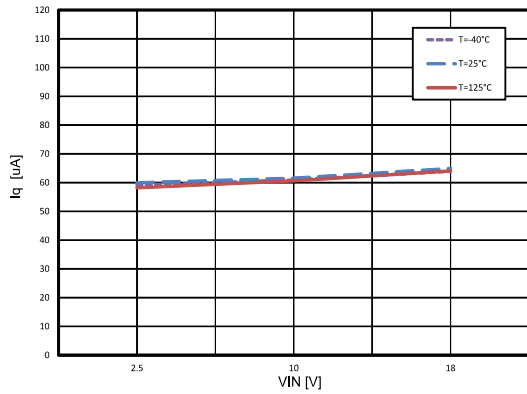

GIPD040820151217MT

Figure 16: Quiescent current vs temperature
($I_{OUT} = 1\text{ mA}$)

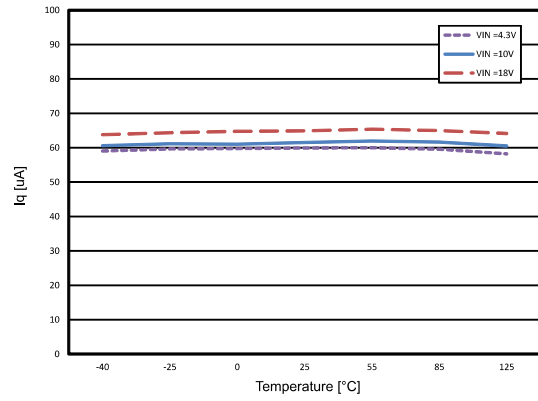

GIPD040820151218MT

Figure 17: Quiescent current vs output current
($V_{IN} = 4.3\text{ V}$)

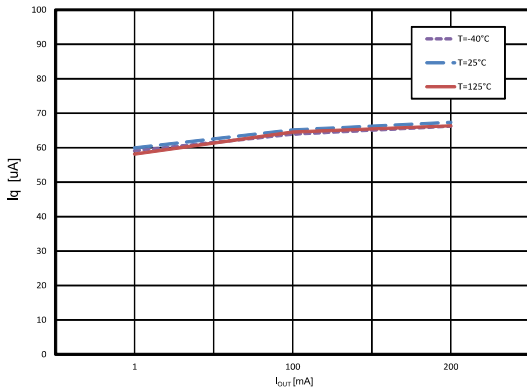

GIPD040820151219MT

Figure 18: Quiescent current vs temperature
($I_{OUT} = 200\text{ mA}$)

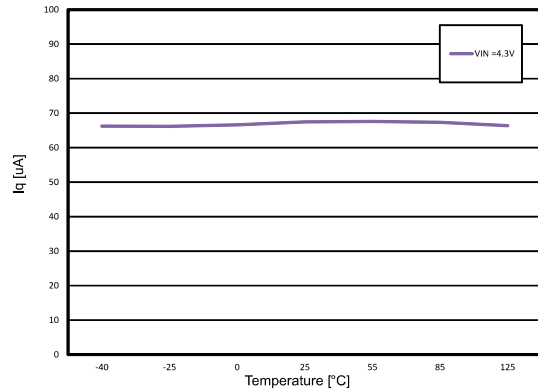

GIPD040820151220MT

Figure 19: Off-state current vs temperature

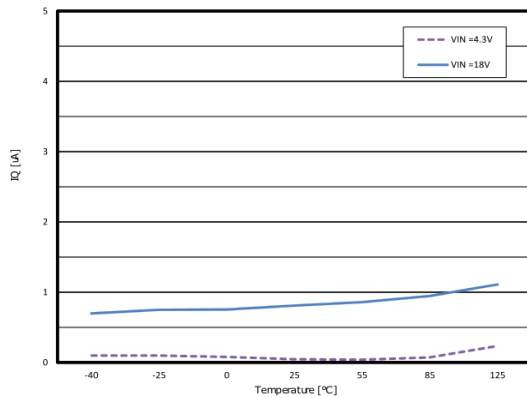

GIPD040820151221MT

Figure 20: Short-circuit current vs temperature
($V_{IN} = 4.3\text{ V}$)

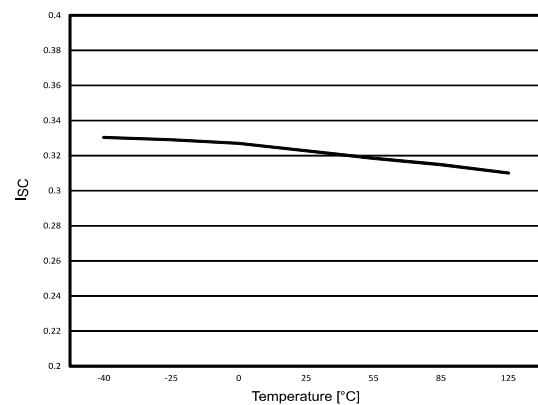

GIPD040820151222MT

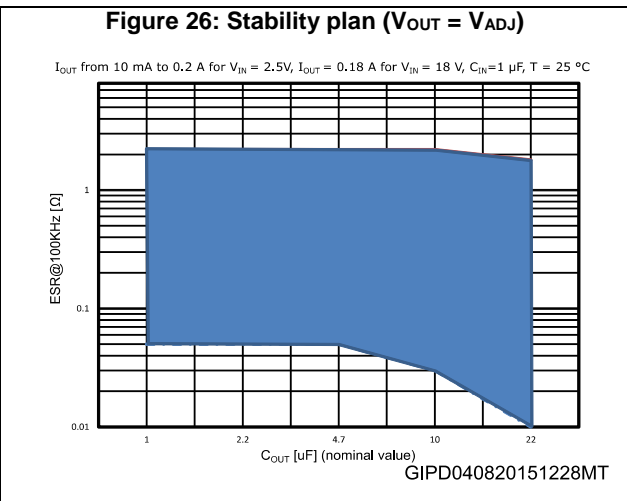
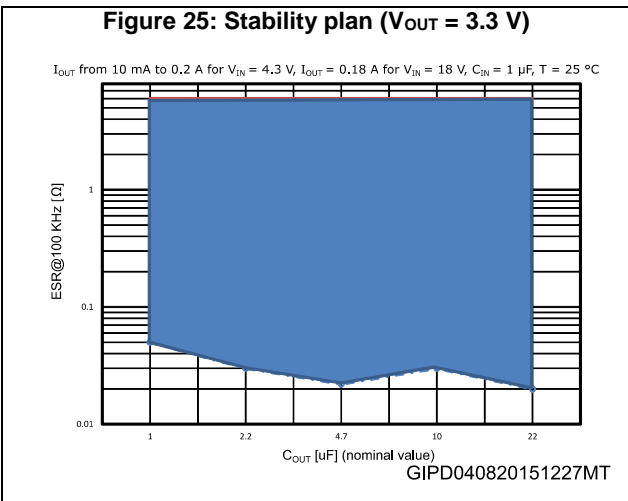
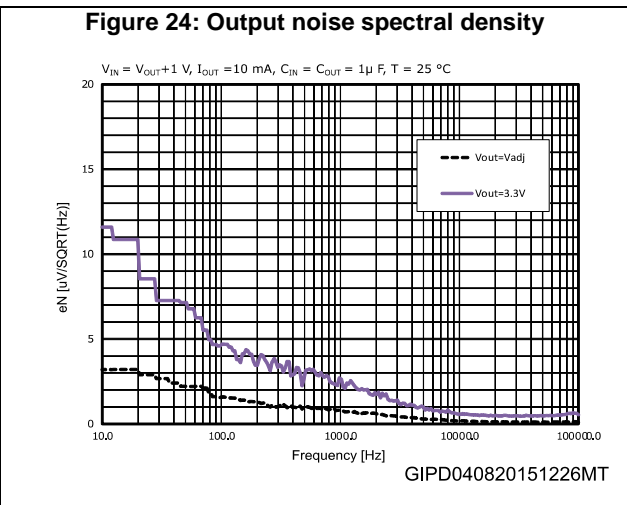
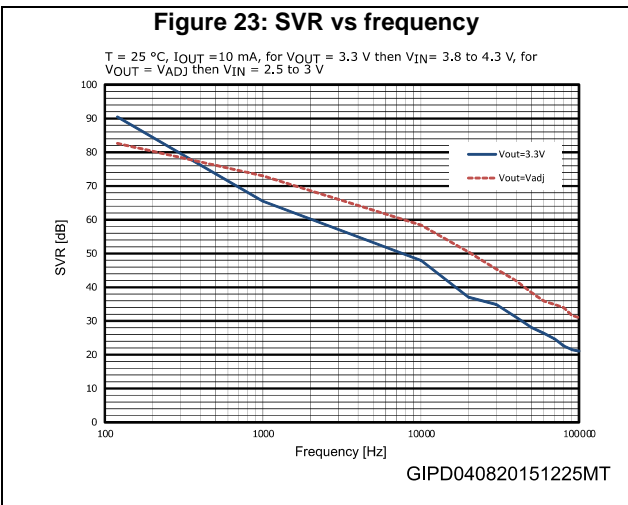
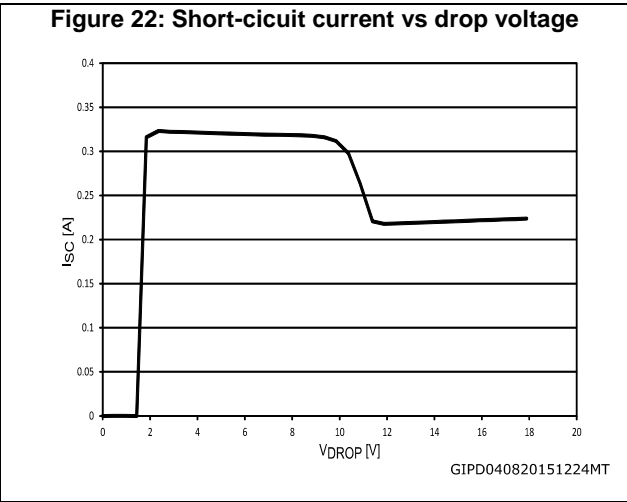
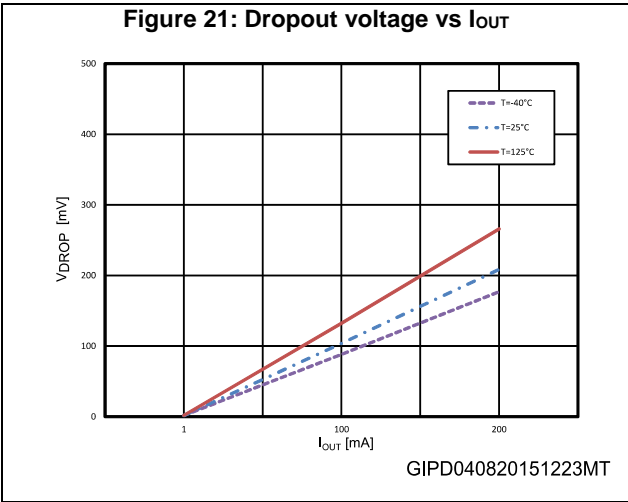
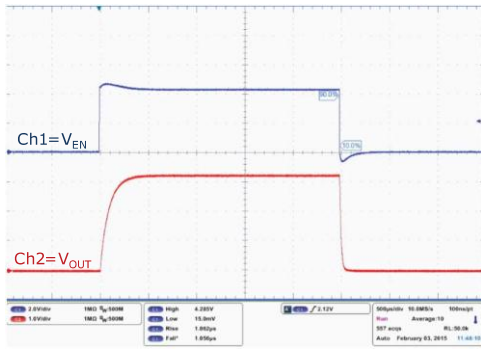

Figure 27: Startup with enable ($V_{OUT} = 3.3\text{ V}$)

$V_{IN} = 4.3\text{ V}$, V_{EN} = from 0 to V_{in} , $I_{OUT} = 200\text{ mA}$, $C_{IN} = C_{OUT} = 1\text{ }\mu\text{F}$ $t_{rise} = t_{fall} = 1\text{ }\mu\text{s}$



GIPD040820151229MT

Figure 28: Startup with enable ($V_{OUT} = V_{ADJ}$)

$V_{IN} = 18\text{ V}$, V_{EN} = from 0 to V_{in} , $I_{OUT} = 200\text{ mA}$, $C_{IN} = C_{OUT} = 1\text{ }\mu\text{F}$ $t_{rise} = t_{fall} = 1\text{ }\mu\text{s}$

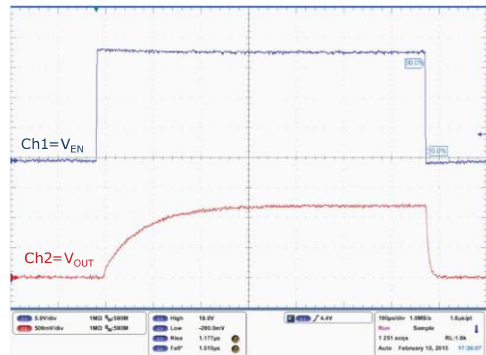

GIPD040820151230MT

Figure 29: Turn-on time ($V_{OUT} = 3.3\text{ V}$)

$V_{IN} = V_{EN}$ = from 0 to 4.3 V , $I_{OUT} = 200\text{ mA}$, $C_{IN} = C_{OUT} = 1\text{ }\mu\text{F}$, $T_{rise} = 1\text{ }\mu\text{s}$

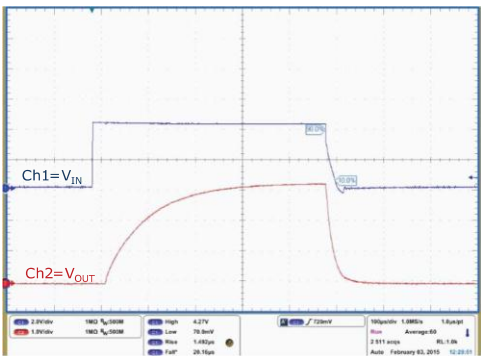

GIPD040820151231MT

Figure 30: Turn-on time ($V_{OUT} = V_{ADJ}$)

$V_{IN} = V_{EN}$ = from 0 to 18 V , $I_{OUT} = 200\text{ mA}$, $V_{OUT} = V_{REF}$, $C_{IN} = C_{OUT} = 1\text{ }\mu\text{F}$ $T_{rise} = 5\text{ }\mu\text{s}$

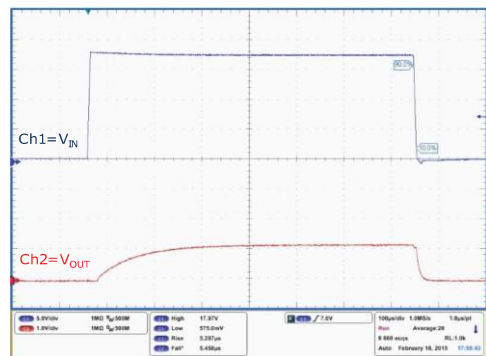

GIPD040820151232MT

Figure 31: Line transient ($V_{OUT} = 3.3\text{ V}$, rise)

$V_{IN} = V_{EN}$ = from 4.3 to 8.3 V , $I_{OUT} = 10\text{ mA}$, $C_{IN} = C_{OUT} = 1\text{ }\mu\text{F}$ $T_{rise} = 5\text{ }\mu\text{s}$

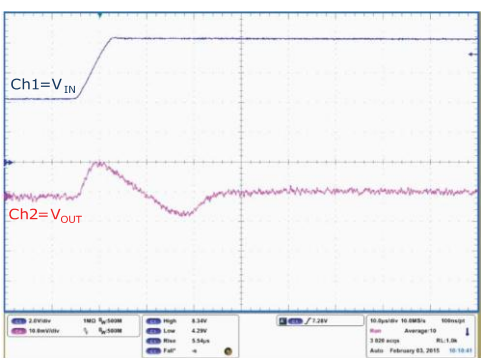

GIPD040820151233MT

Figure 32: Line transient ($V_{OUT} = 3.3\text{ V}$, fall)

$V_{IN} = V_{EN}$ = from 4.3 to 8.3 V , $I_{OUT} = 10\text{ mA}$, $C_{IN} = C_{OUT} = 1\text{ }\mu\text{F}$ $T_{fall} = 5\text{ }\mu\text{s}$

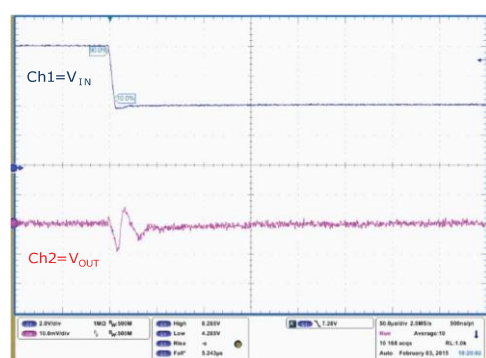

GIPD040820151234MT

Figure 33: Load transient ($V_{OUT} = 3.3\text{ V}$, rise)

$V_{IN} = V_{EN} = 4.3\text{ V}$, I_{OUT} = from 1 to 200 mA, $C_{IN} = C_{OUT} = 1\text{ }\mu\text{F}$ $T_{rise} = 5\text{ }\mu\text{s}$

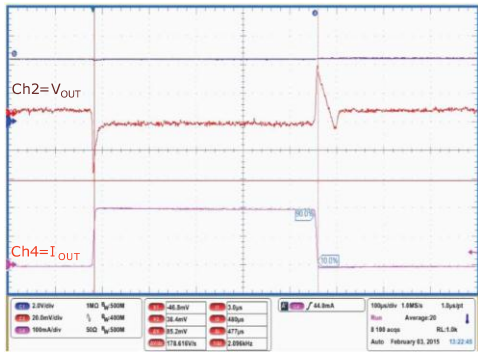

GIPD040820151236MT

Figure 34: Load transient ($V_{OUT} = V_{ADJ}$, fall)

$V_{IN} = V_{EN} = 2.5\text{ V}$, I_{OUT} = from 1 to 200 mA, $C_{IN} = C_{OUT} = 1\text{ }\mu\text{F}$ $T_{rise} - T_{fall} = 5\text{ }\mu\text{s}$

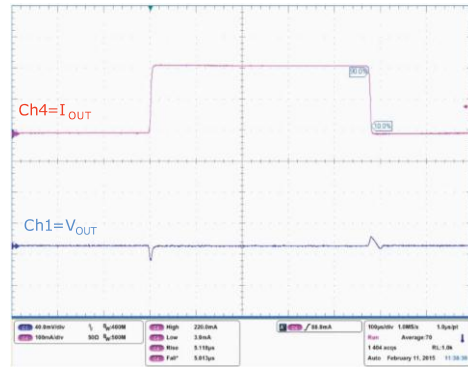

GIPD040820151237bMT

7 Package information

In order to meet environmental requirements, ST offers these devices in different grades of ECOPACK® packages, depending on their level of environmental compliance. ECOPACK® specifications, grade definitions and product status are available at: www.st.com. ECOPACK® is an ST trademark.

7.1 SOT23-5L package information

Figure 35: SOT23-5L package outline

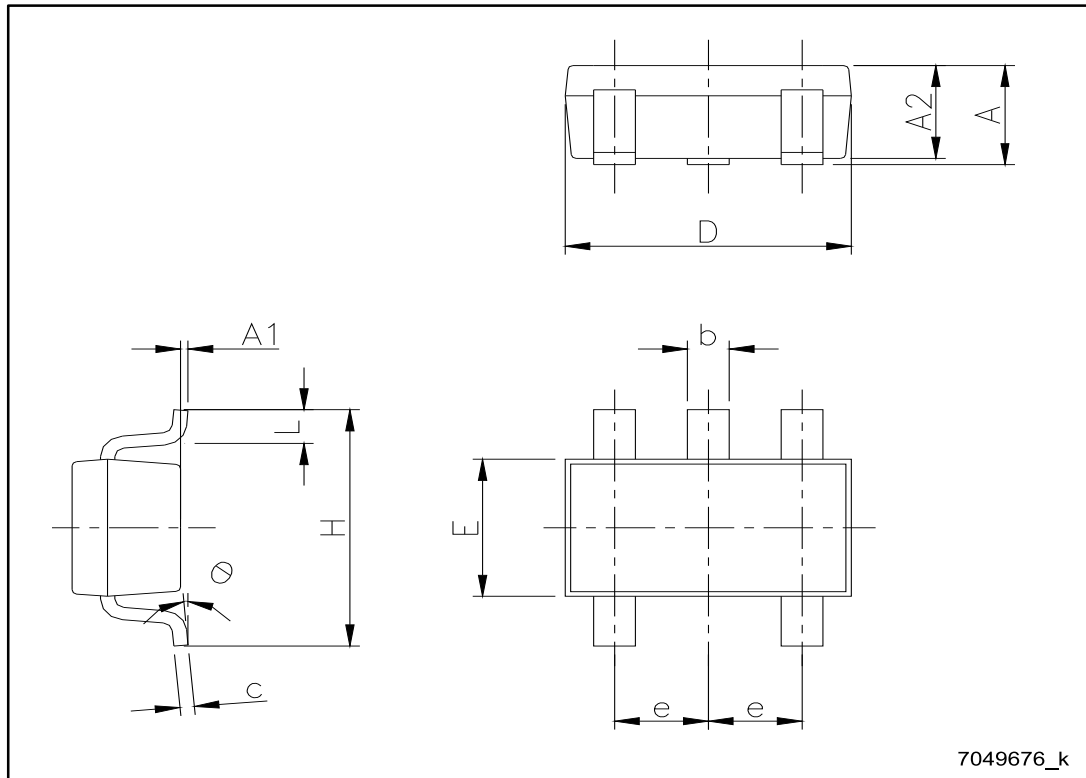
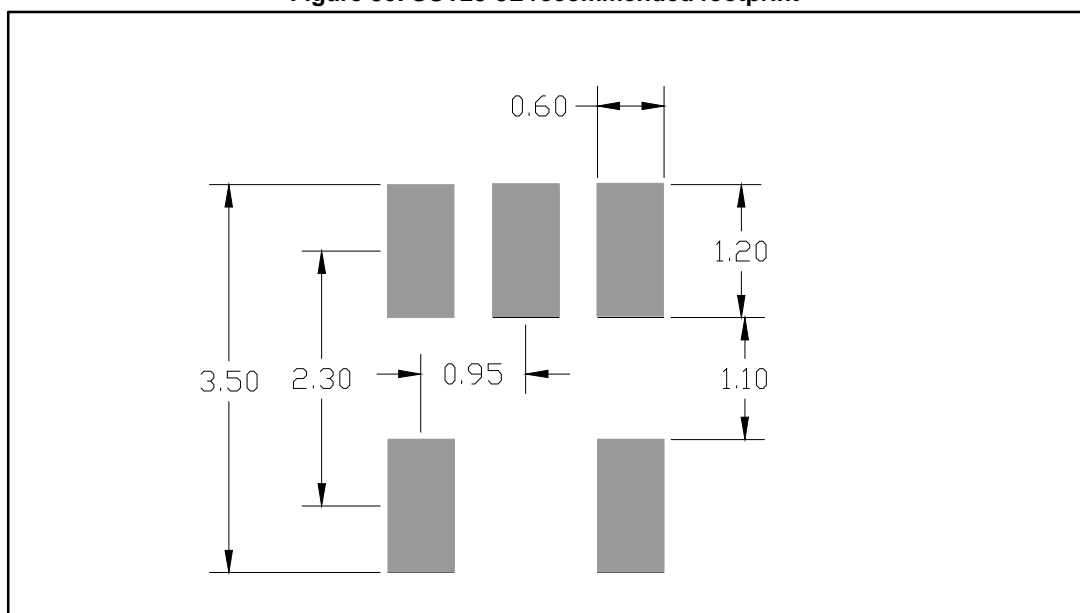

Table 8: SOT23-5L package mechanical data

Dim.	mm		
	Min.	Typ.	Max.
A	0.90		1.45
A1	0		0.15
A2	0.90		1.30
b	0.30		0.50
c	0.09		0.20
D		2.95	
E		1.60	
e		0.95	
H		2.80	
L	0.30		0.60
θ	0°		8°

Figure 36: SOT23-5L recommended footprint



Dimensions are in mm

7.2 SOT23-5L packing information

Figure 37: SOT23-5L tape and reel outline

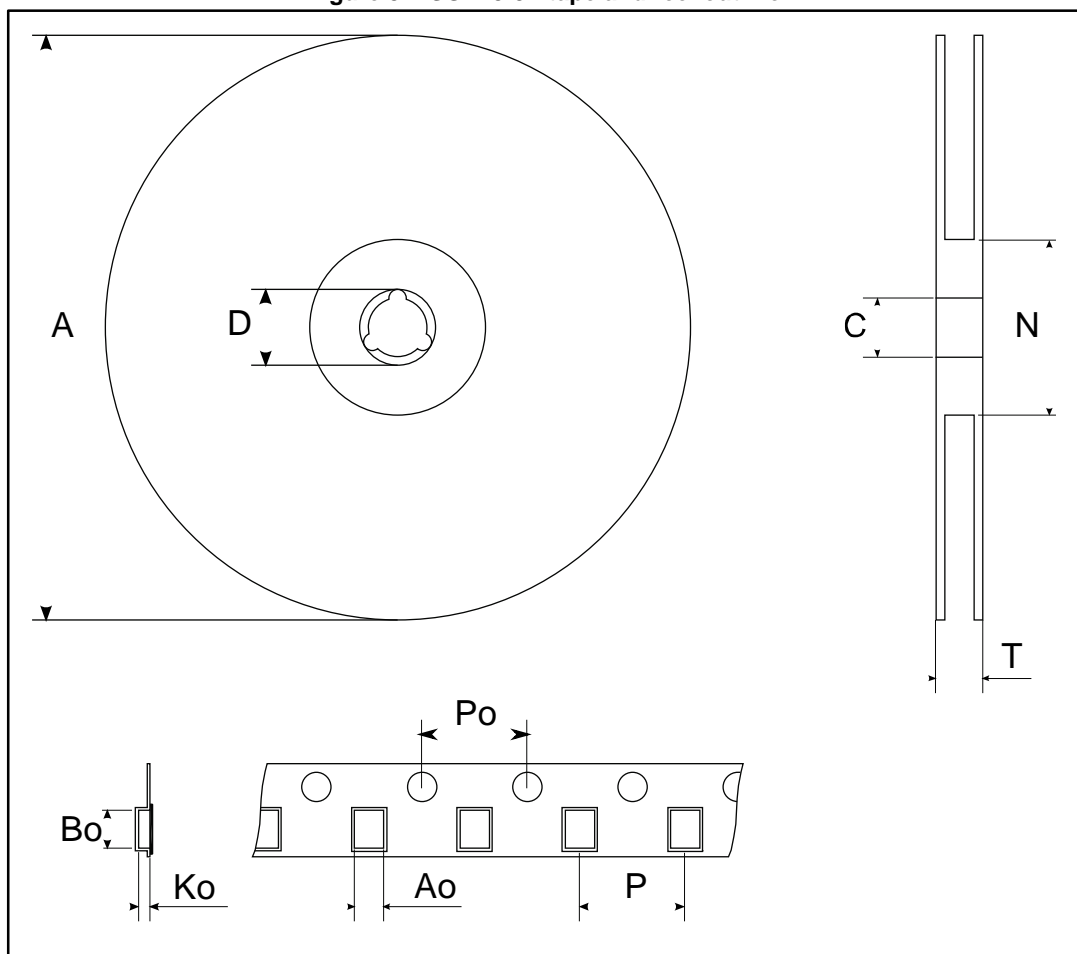

Table 9: SOT23-5L tape and reel mechanical data

Dim.	mm		
	Min.	Typ.	Max.
A			180
C	12.8	13.0	13.2
D	20.2		
N	60		
T			14.4
Ao	3.13	3.23	3.33
Bo	3.07	3.17	3.27
Ko	1.27	1.37	1.47
Po	3.9	4.0	4.1
P	3.9	4.0	4.1

7.3 SOT-89 package information

Figure 38: SOT-89 package outline

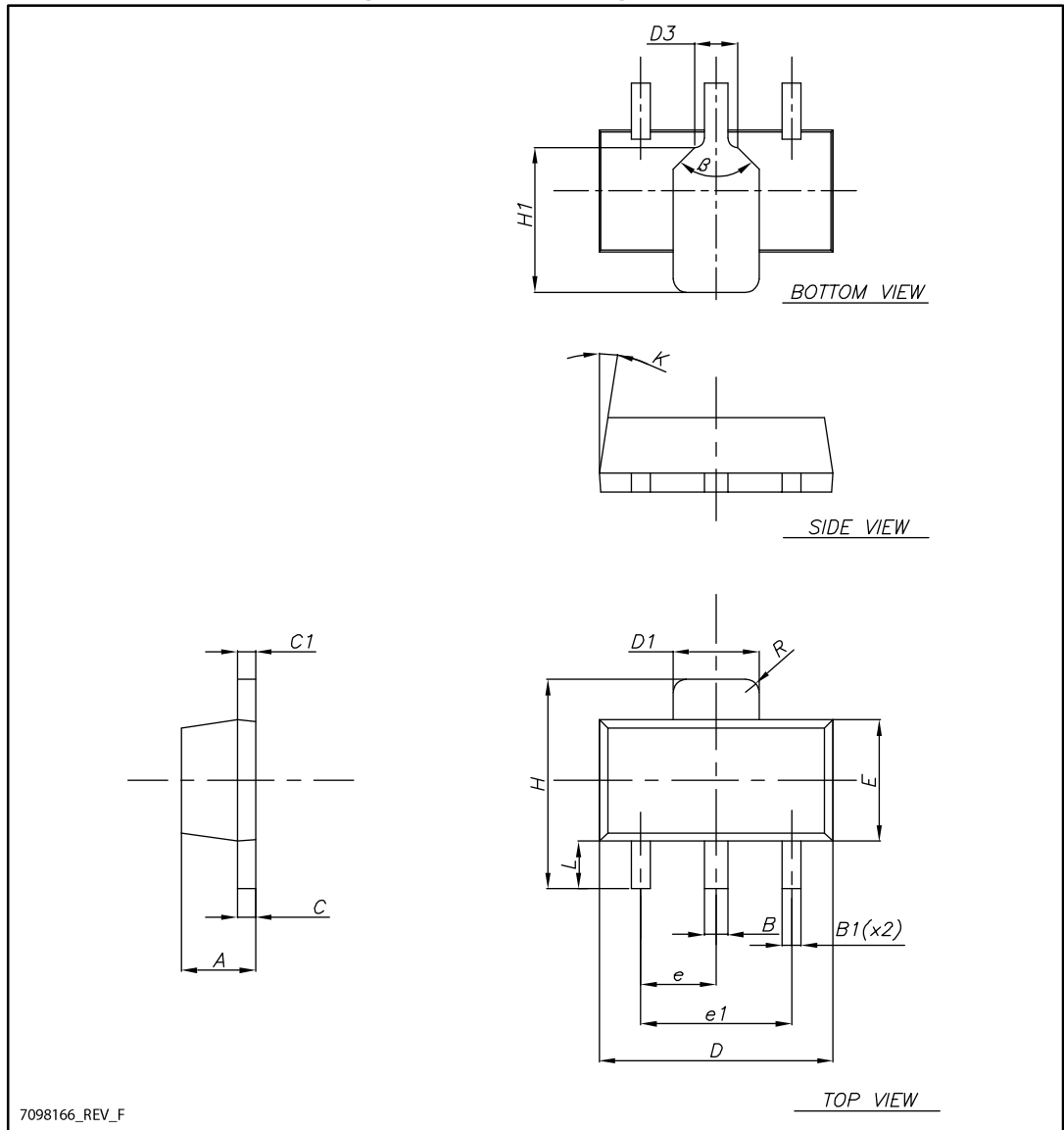
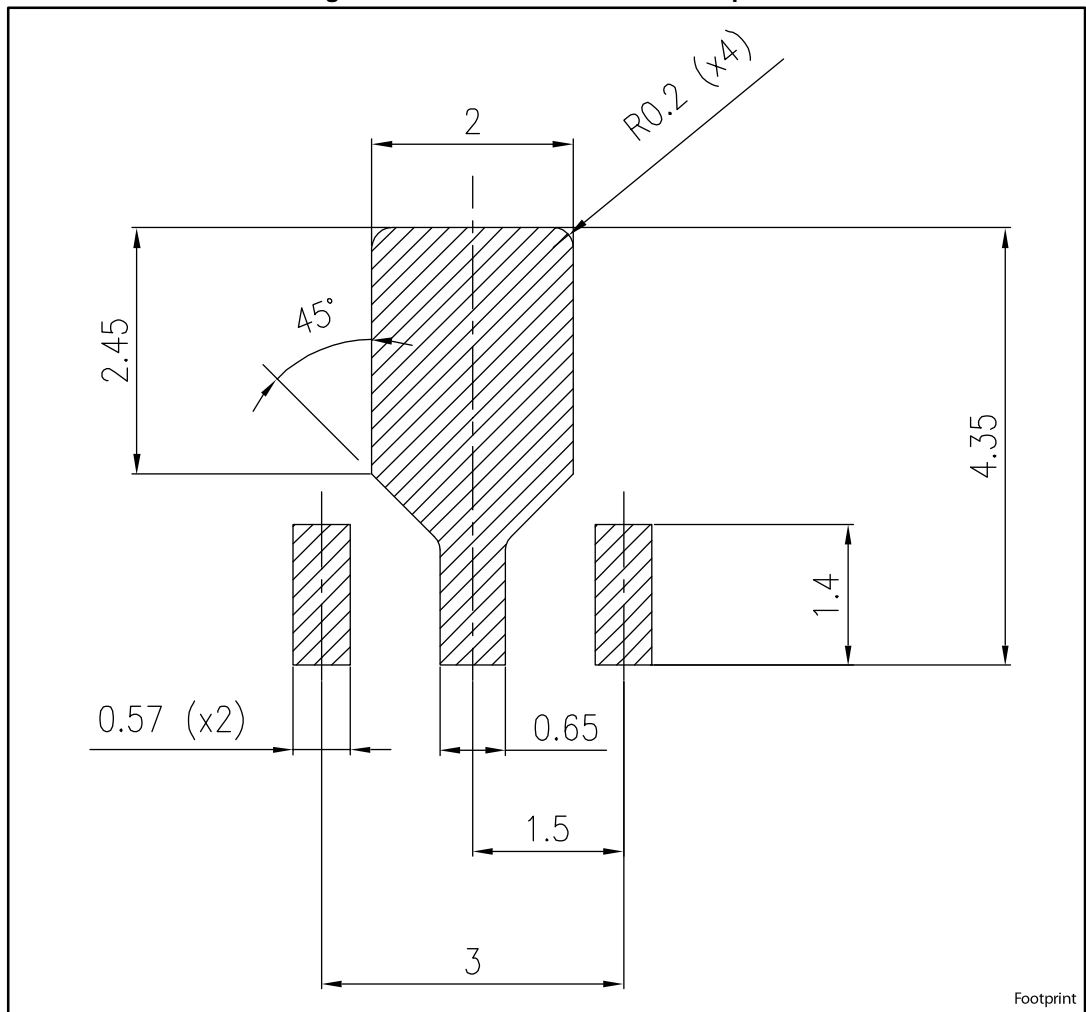

Table 10: SOT-89 mechanical data

Dim.	mm		
	Min.	Typ.	Max.
A	1.40		1.60
B	0.44		0.56
B1	0.36		0.48
C	0.35		0.44
C1	0.35		0.44
D	4.40		4.60
D1	1.62		1.83
D3		0.90	
E	2.29		2.60
e	1.42		1.57
e1	2.92		3.07
H	3.94		4.25
H1	2.70		3.10
K	1°		8°
L	0.89		120
R		0.25	
β		90°	

Figure 39: SOT-89 recommended footprint



7.4 SOT-89 packing information

Figure 40: SOT-89 carrier tape outline

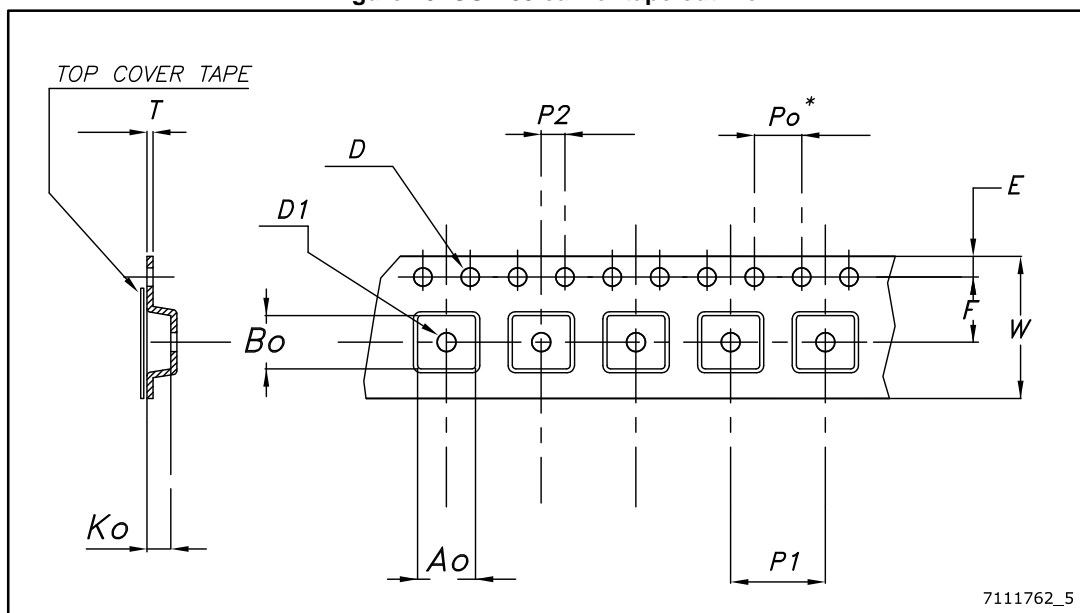

7111762_5

Table 11: SOT-89 carrier tape mechanical data

Dim.	mm	
	Value	Tolerance
Ao	4.91	± 0.10
Bo	4.52	± 0.10
Ko	1.90	± 0.10
F	5.50	± 0.10
E	1.75	± 0.10
W	12	± 0.30
P2	2	± 0.10
Po	4	± 0.10
P1	8	± 0.10
T	0.30	± 0.10
D	Ø 1.55	± 0.05
D1	Ø 1.60	± 0.10

8 Ordering information

Table 12: Order code

SOT23-5L	SOT-89 (D configuration)	Accuracy (%)	Output voltage
LDK320AM-R		0.5	ADJ
LDK320M-R		2	
LDK320AM12R ⁽¹⁾		0.5	1.2
LDK320M12R ⁽¹⁾		2	
LDK320AM15R ⁽¹⁾		0.5	1.5
LDK320M15R ⁽¹⁾		2	
LDK320AM18R ⁽¹⁾		0.5	1.8
LDK320M18R ⁽¹⁾		2	
LDK320AM25R ⁽¹⁾		0.5	2.5
LDK320M25R ⁽¹⁾		2	
LDK320AM30R	LDK320ADU30R ⁽¹⁾	0.5	3
LDK320M30R		2	
LDK320AM33R ⁽¹⁾	LDK320ADU33R ⁽¹⁾	0.5	3.3
LDK320M33R ⁽¹⁾		2	
LDK320AM36R ⁽¹⁾		0.5	3.6
LDK320M36R ⁽¹⁾		2	
LDK320AM50R ⁽¹⁾	LDK320ADU50R ⁽¹⁾	0.5	5
LDK320M50R ⁽¹⁾		2	
LDK320AM120R ⁽¹⁾	LDK320ADU120R ⁽¹⁾	0.5	12
LDK320M120R ⁽¹⁾		2	

Notes:

⁽¹⁾Available on request.

9 Revision history

Table 13: Document revision history

Date	Revision	Changes
16-Nov-2015	1	First release.
01-Jun-2016	2	Document status promoted from preliminary data to production data. Updated title and features in cover page. Updated Section 8: "Ordering information" . Minor text changes.

IMPORTANT NOTICE – PLEASE READ CAREFULLY

STMicroelectronics NV and its subsidiaries ("ST") reserve the right to make changes, corrections, enhancements, modifications, and improvements to ST products and/or to this document at any time without notice. Purchasers should obtain the latest relevant information on ST products before placing orders. ST products are sold pursuant to ST's terms and conditions of sale in place at the time of order acknowledgement.

Purchasers are solely responsible for the choice, selection, and use of ST products and ST assumes no liability for application assistance or the design of Purchasers' products.

No license, express or implied, to any intellectual property right is granted by ST herein.

Resale of ST products with provisions different from the information set forth herein shall void any warranty granted by ST for such product.

ST and the ST logo are trademarks of ST. All other product or service names are the property of their respective owners.

Information in this document supersedes and replaces information previously supplied in any prior versions of this document.

© 2016 STMicroelectronics – All rights reserved