



Datenblatt - Fiche technique - Data sheet

11.01.3645



ROLINE RS232 Kabel ST-BU, 4,5m

ROLINE Câble RS-232 M/F, 4,5m

ROLINE RS232 Cable, M - F, 4.5 m

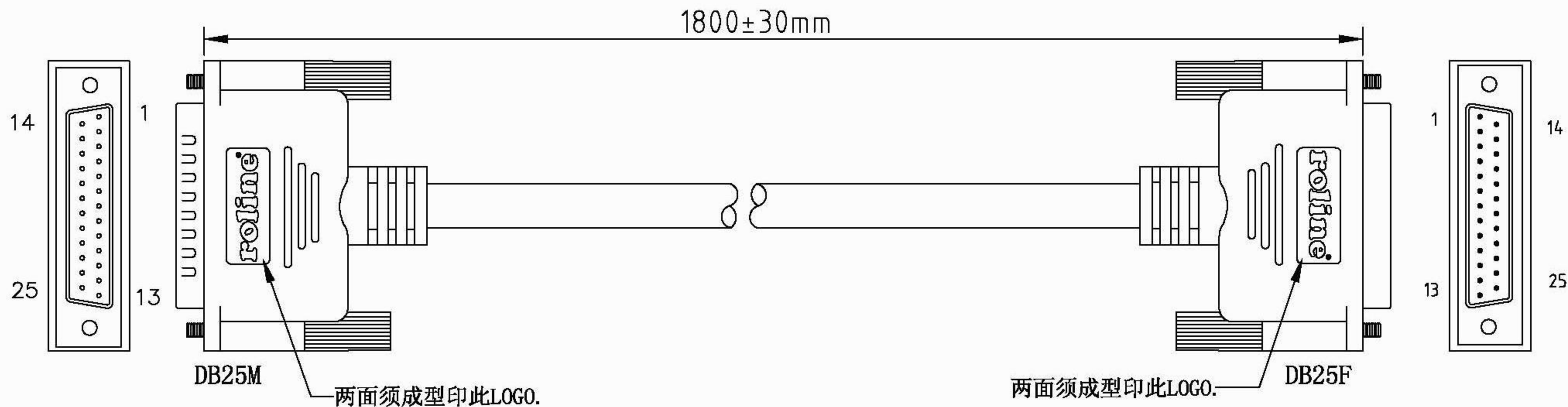

NOTE: 注:线材用RLA专用米色!! 包装方式:1PCS PE BAG+吊卡+条码贴纸包装

1. CABLE: 28AWG,NON-UL,AL-FOIL,25C+1,(RLA)BEIGE COLOR,OD=7.0mm,PVC JACKET.

2. LENGTH: 1800mm

3. CONNECTORS: DB25M*1PCS,DB25F*1PCS (黑膠芯)

4. MOLD: 成型APPLE模——成型APPLE模

5. SCREW: 4*40 INCH SCREW*4PCS.

6. CONTACTS:

DB25M	1	2	3	4	24	25	64
DB25F	1	2	3	4	24	25	64

7. OPEN/SHORT TEXT 100% TEXT.

INSULATION: MIN. 2M.

8. ALL MUST BE ROHS COMPLIANT.

料号	颜色	长度
11.01.3618	RLA(米色)	1800±30mm
11.01.3630	RLA(米色)	3000±30mm
11.01.3645	RLA(米色)	4500±30mm
11.01.3660	RLA(米色)	6000±30mm

COMPANY	RLA		ITEM NO.	11.01.3618	編號	B3863	Rotronic Co., Ltd.	SCALE	
REVISION	DATE	DISCRIPTION	DRAWN BY					UNIT(mm)	
REV.A/0	2006.04.27	C9-2604033	DESIGNED BY					DRAWING NO.	
			APPROVAL BY						