

Stahl / Edelstahl Klappgriffe

Steel / Stainless Steel Collapsible Handles

Technische Daten	Technical Data
Werkstoff: 286 + 3286: Halterung Messing verchromt	Material: 286 + 3286: Holding Device Brass chromium plated
Griff Stahl verchromt	Handle Steel chromium plated
3486: X5 CrNi 18 10, No. 1.4301	Material: 3486: X5 CrNi 18 10, No. 1.4301
Belastbarkeit: 1000N / Paar	Carrying capacity: 1000N / Pair
Anzugsdrehmoment: max. 8Nm	Tightening moment: max. 8Nm

Klappgriff in drei Ausführungsarten für den Einsatz an Messgeräten. Der Griff wird in beiden Endstellungen durch eine Feder arretiert.

Collapsible handle in three design types for the use on measuring devices. In both end positions, the handle is locked with a spring.



Ausführung verchromt
Chromium plated version



Ausführung verchromt mit Kunststoffüberzug
Chromium plated with plastic coating version



Ausführung in rostfreiem Edelstahl, Oberfläche matt glänzend
Stainless Steel, surface shiny matt

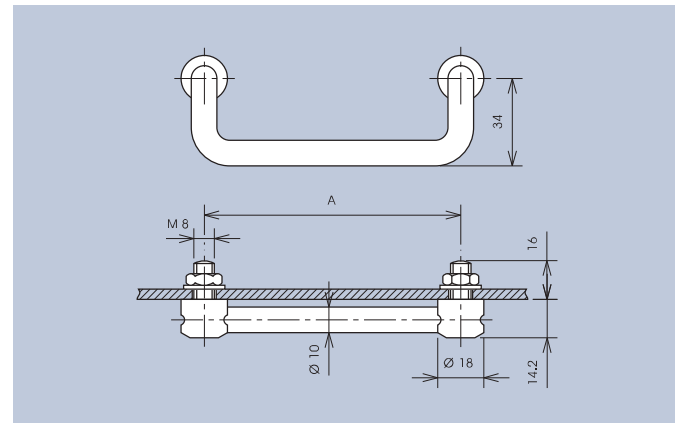

Einschließlich Muttern-M8 und Scheiben.
Including nuts-M8 and washers.

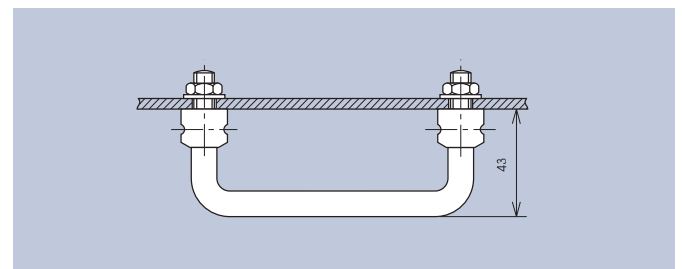

ausgeklappt · extracted

A	verchromt chromium plated Art.-Nr.	Kunststoffüberzug Plastic coating Art.-Nr.	Edelstahl Stainless steel Art.-Nr.
100	286.6	3286.1003	3486.1001
120	286.3	3286.1203	3486.1201