

Spherical Washers / Conical Seats • DIN 6319

23050.0039

Product Description

Spherical washers / Conical seats are used as washers in a screw connection to compensate non-parallel surfaces.



Material

Spherical washer

- Case-hardened steel, case-hardened, manganese phosphated

Assembly

Conical seats form D are to be used only for plain, closed round areas.
For larger holes only use form G!

More information

Further products

- Spherical Washers / Conical Seats, similar to DIN 6319, stainless steel
- Fixture Nuts, DIN 6330 (height 1,5 d)

Drawing

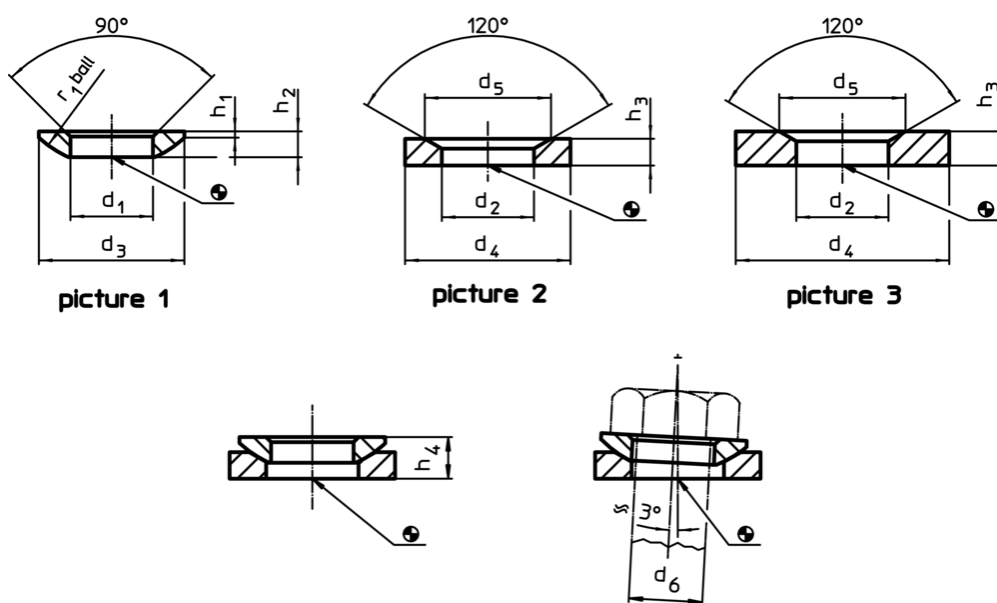

Order information

d ₁ H13	d ₃	Dimensions				r ₁	For pin d ₆	For screws d ₆	Load capacity for static load ¹⁾ max.	Torque for screwed connections ^{1) 2)} max.	Art. No. ³⁾
		h ₁	h ₂	h ₄ with conical seat form D	[mm]						
spherical washers from case-hardened steel, form C – picture 1											
40	75	5.6	16	26.8	54	39	M39	460	3276	280	23050.0039

¹⁾ Figures theoretically determined

²⁾ Torques of screws with standard thread, eventual pre-loads to be considered, coefficient of friction μ_{total} 0.14.

³⁾ DIN standards do not include these dimensions.

Application example



Compliance

RoHS compliant

Compliant according to Directive 2011/65/EU and Directive 2015/863

Does not contain SVHC substances

No SVHC substances with more than 0.1% w/w contained - SVHC list [REACH] as of 10.06.2022

Does not contain Proposition 65 substances

No Proposition 65 substances included
<https://www.P65Warnings.ca.gov/>

Free from Conflict Minerals

This product does not contain any substances designated as "conflict minerals" such as tantalum, tin, gold or tungsten from the Democratic Republic of Congo or adjacent countries.