

Product Data Sheet 3212 JH4

**ebmpapst**

The engineer's choice



**3212 JH4****INDEX**

<b>1</b>	<b>General .....</b>	<b>3</b>
<b>2</b>	<b>Mechanics .....</b>	<b>3</b>
2.1	General .....	3
2.2	Connections .....	3
<b>3</b>	<b>Operating Data .....</b>	<b>4</b>
3.1	Electrical Operating Data .....	4
3.2	Electrical Features .....	4
3.3	Aerodynamics .....	5
3.4	Sound Data .....	6
<b>4</b>	<b>Environment.....</b>	<b>6</b>
4.1	General .....	6
4.2	Climatic Requirements.....	6
<b>5</b>	<b>Safety .....</b>	<b>7</b>
5.1	Electrical Safety .....	7
5.2	Approval Tests .....	7
<b>6</b>	<b>Reliability.....</b>	<b>7</b>
6.1	General .....	7

**1 General**

Fan type	Fan	
Rotating direction looking at rotor	Clockwise	
Airflow direction	Air outlet over struts	
Bearing system	Ball bearing	
Mounting position - shaft	Any	

**2 Mechanics**

**2.1 General**

Width	92,0 mm	
Height	92,0 mm	
Depth	38,0 mm	
Mass	0,280 kg	
Housing material	Plastic	
Impeller material	Plastic	
Max. torque when mounted across both mounting flanges	Wire outlet corner: 30 Ncm Remaining corners: 30 Ncm	
Screw size	ISO 4762 - M4 degreased, without an additional brace and without washer	

**2.2 Connections**

Electrical connection	Wires	
Lead wire length	L = 310 mm	
Tolerance	+ - 10,0 mm	

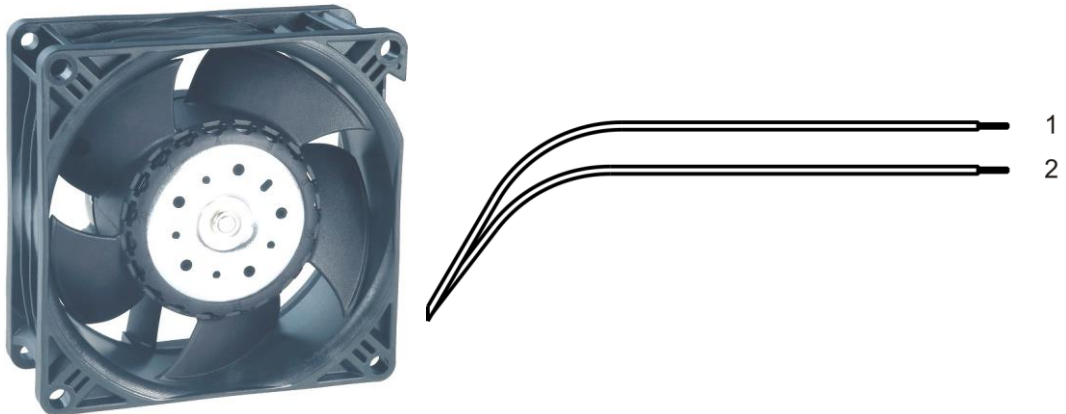

Wire	Color	Operation	Wire size	Insulation diameter
1	red	+ UB	AWG 22	1,30 mm
2	blue	- GND	AWG 22	1,30 mm

### 3 Operating Data

#### 3.1 Electrical Operating Data

Measurement conditions: Normal air density = 1,2 kg/m<sup>3</sup>; Temperature 23°C +/- 3°C; Motor axis horizontal; warm-up time before measuring 5 minutes (unless otherwise specified). In the intake and outlet area should not be any solid obstruction within 0,5 m.

$\Delta p = 0$ : corresp. to free air flow (see chapter aerodynamics)  
 I: corresp. to arithm. mean current value

Features	Condition	Symbol	Values		
Voltage range		U	6 V		13,8 V
Nominal voltage		$U_N$		12 V	
Power consumption	$\Delta p = 0$	P	10 W	50 W	55 W
Tolerance	0010		+/- 17,5 %	+/- 17,5 %	+/- 25 %
Current consumption	$\Delta p = 0$	I	1.670 mA	4.200 mA	4.000 mA
Tolerance	0010		+/- 17,5 %	+/- 17,5 %	+/- 25 %
Speed	$\Delta p = 0$	n	7.200 1/min	13.000 1/min	13.000 1/min
Tolerance	0010		+/- 12,5 %	+/- 7,5 %	+/- 3 %
Starting current consumption				<= 14.500 mA	

#### 3.2 Electrical Features

Electronic function	Speed-Controlled	
Reversed polarity protection	Rectifying diode	
Max. residual current at $U_N$	$I_F \leq 450 \mu A$	
Locked rotor protection	Auto restart	
Locked rotor current at $U_N$	$I_{block}$ approx. 14.500 mA	
Clock signal at locked rotor	$t_3 / t_4$ typical: 0,5 s / 10,0 s	

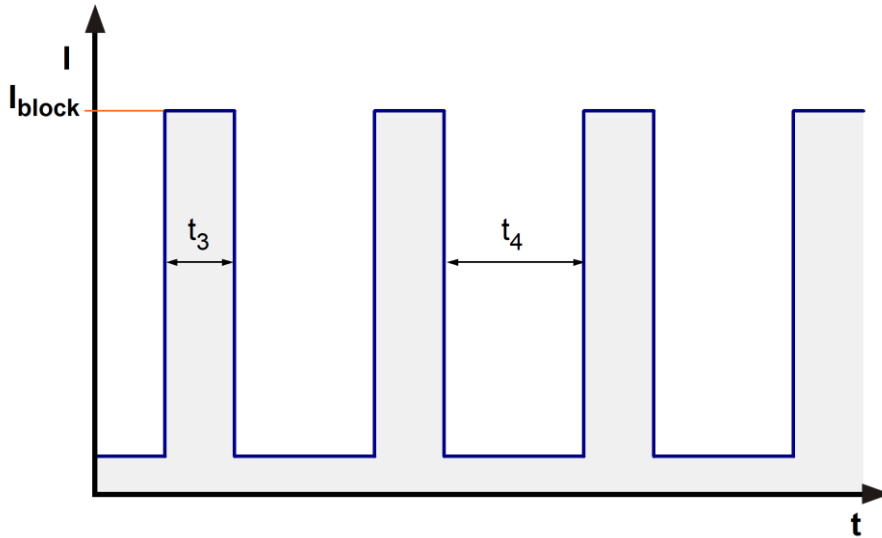

### 3.3 Aerodynamics

Measurement conditions:

Measured with a double chamber intake rig acc. to DIN EN ISO 5801.

Normal air density = 1,2 kg/m<sup>3</sup>; Temperature 23°C +/- 3°C;

In the intake and outlet area should not be any solid obstruction within 0,5 m. Motor shaft horizontal.

The information is only valid under the specified test conditions and may be changed by the installation conditions. If there are deviations from the standard test conditions, the characteristic values must be checked under the installed conditions.

a.) Operation condition:

13.000 1/min at free air flow
-------------------------------

Max. free-air flow ( $\Delta p = 0 / \dot{V} = \text{max.}$ )	285,0 m <sup>3</sup> /h	
Max. static pressure ( $\Delta p = \text{max.} / \dot{V} = 0$ )	800 Pa	

**3.4 Sound Data**

Measurement conditions: Sound pressure level: 1 meter distance between microphone and the air intake.  
 Sound power level: Acc. to DIN 45635 part 38 (ISO 10302)  
 Measured in a semianchoic chamber with a background noise level of  $L_p(A) < 5 \text{ dB(A)}$   
 For further measurement conditions see chapter aerodynamics.

a.) Operation condition:

13.000 1/min at free air flow
-------------------------------

Optimal operating point	190,0 m3/h @ 374 Pa	
Sound power level at the optimal operating point	8,0 bel(A)	
Sound pressure level at free air flow, measured in rubber bands	76,0 dB(A)	

**4 Environment**

**4.1 General**

Min. permitted ambient temperature TU min.	-20 °C	
Max. permitted ambient temperature TU max.	70 °C	
Min. permitted storage temperature TL min.	-40 °C	
Max. permitted storage temperature TL max.	80 °C	

**4.2 Climatic Requirements**

Humidity requirements	humid heat, constant; according to DIN EN 60068-2-78, 14 days	
Water exposure	None	
Dust requirements	None	
Salt fog requirements	None	

Permitted application area:

The product is intended for use in sheltered rooms with controlled temperature and controlled humidity. Directly exposure to water must be avoided.

Pollution degree 1 (according DIN EN 60664-1)

There is either no pollution or it occurs only dry, non-conductive pollution. The pollution has no negative impact.

Please require severity levels and specification parameters from the responsible development departments.

**5 Safety**

**5.1 Electrical Safety**

Dielectric strength DIN EN 60950 (VDE 0805) and DIN EN 60335 (VDE 0700) A.) Type test Measuring conditions: After 48h of storage at 95% R.H. and 25°C. No arcing or breakdown is allowed! All connections together to ground.	500 VAC / 1 Min.	
B.) Routine test Measuring conditions: At indoor climate. No arcing or breakdown is allowed! All connections together to ground.	850 VDC / 1 Sec.	
Isolation resistance Measuring conditions: After 48h of storage at 95% R.H. and 25°C measured with U=500 VDC for 1 min.	RI > 10 MOhm	
Clearance / creepage distance	1,0 mm / 1,2 mm	
Protection class	III	

**5.2 Approval Tests**

CE	EC Declaration of Conformity	Yes
EAC	Eurasian Conformity	Yes
UL	Underwriters Laboratories	Yes / UL507, Electric Fans
VDE	Association for Electrical, Electronic and Information Technologies	Yes / Approval acc. to EN 60950 (VDE 0805) - Information technology equipment
CSA	Canadian Standards Association	Yes / C22.2 No. 113 Fans and Ventilators
CCC	China Compulsory Certification	Not applicable

**6 Reliability**

**6.1 General**

Life expectancy L10 at TU = 40 °C	60.000 h	
Life expectancy L10 at TU max.	30.000 h	
Life expectancy L10 acc. to IPC 9591 at TU = 40 °C	102.500 h	

Copying of this document, and giving it others and the use or communication of the contents thereof, are forbidden without express authority. Offenders are liable to the payment of damages. All rights are reserved in the event of the grant of a patent or the registration of a utility model or design.

Schutzmerk nach DIN ISO 10165 Instruktion 1 Refer to protection notice DIN ISO 10165 1

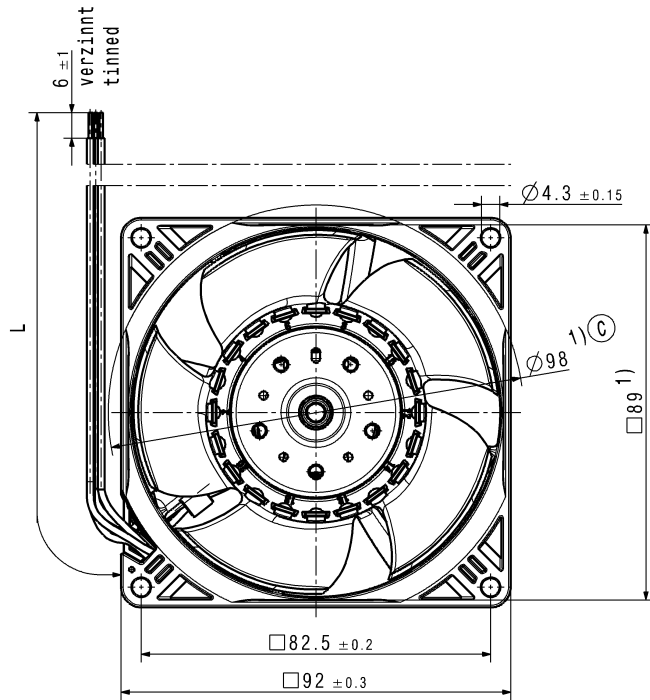

Vorderansicht  
Maßstab: 1:1  
front view  
scale: 1:1

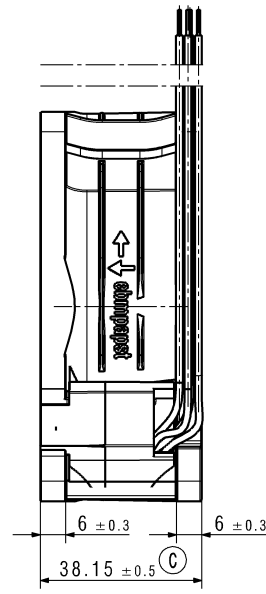

Seitenansicht links  
Maßstab: 1:1  
side view left  
scale: 1:1

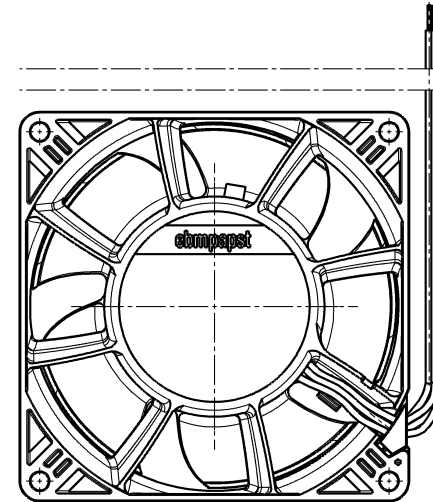



Rückansicht  
Maßstab: 1:1  
back view  
scale: 1:1

Zeichnung entspricht 3D-Modell:  
Drawing is equivalent to 3D-Model:  
9693520181\_CPR\_000\_C  
System: CATIA V5 R 14

1) Maße für Montagewand  
1) dimension for worktop mounting

-Anzahl und Länge der Litzen siehe Produktspezifikation  
number and length of the wires, look at the product specification

-Kein Axialspiel bei Kugellager durch Federausgleich  
no axial clearance of ball bearings conditional on a pre-load spring

SAP-Status/State		Änd.-Nr./ Change-No.	CATIA-System-Version/ CATIA-System-Version	CAO-Umgebung/ CAD-Environment	Werkstoff / Material:		Volumen / Volume (cm³):
		Datum Name		Artikel / Title:		Gewicht / Mass (g):	
Tolerierung / Tolerances:		Bearb./ Drawn		Zug.-Nr. / Drawing No:		Ers.-f.-Zug. / Replaces:	
Allgemeintoleranzen / Gen. Tolerances:		Gepr./ Checked				Dokumenttyp / Type of Document	
		Freig./ Released:		Teilnummer (Blatt/Page)		Index / Index:	
				Format / Size:		Maßstab/Scale	
		ebm-papst St. Georgen GmbH & Co KG					