

Contacts



TABLE OF CONTENTS

1. DESIGN, SCREW MACHINING AND PLATING CAPABILITY	6-7
2. SIGNAL CONTACTS	8-15
a. Crimp contacts - MILITARY STANDARD	8-11
b. Crimp contacts - EUROPEAN STANDARD	12-13
c. PCB contacts	14
d. Thermo-couples contacts	15
3. POWER CONTACTS	16-19
a. Size 8 contacts	16-17
b. Specific range of products	17
c. Amphenol Radsok technology	18
4. COAXIAL CONTACTS	20-33
a. Introduction	20
b. STANDARD PERFORMANCES	21-24
i. Crimp contacts - MIL-DTL-38999 series II / EN4165	21
ii. Crimp contacts -MIL-DTL-38999 series I,III / EN3645	22-23
c. IMPEDANCE MATCHED COAXIAL CONTACTS	24-25
i. Crimp contacts – MIL-DTL-38999 series I, II, III / EN3645/EN4165	24
d. TYPICAL CONTACT INSTALLATION INSTRUCTIONS	25
e. PRINT CIRCUIT board contacts	26-27
f. RF COAXIAL CONTACTS	28-30
g. 75 OHMS COAXIAL CONTACTS	31-32
5. TWINAX CONTACTS	34-39
a. Introduction	34
b. Crimp contacts – MILITARY STANDARD	35
c. Crimp contacts – EUROPEAN and AIRBUS STANDARD	36
d. Crimp contacts – 1760 INTERFACE	37
e. Crimp contacts – ARINC 600	37
f. TYPICAL CONTACT INSTALLATION INSTRUCTIONS	38
g. PCB contacts	39
6. DIFFERENTIAL TWINAX CONTACTS	40-41
7. QUADRAX CONTACTS	42-47
a. Introduction	42
b. Crimp contacts	43
c. TYPICAL CONTACT INSTALLATION INSTRUCTIONS	44
d. PCB Contacts	45
e. Crimp and PCB contacts - ARINC 600	46

TABLE OF CONTENTS

8. SPLIT PAIR QUADRAX CONTACTS	48
9. μ COM CONTACTS	49
10. High-speed cordsets	50
11. OPTICAL TERMINI	51-57
a. M29504/4 & /5	52
b. Lux-Beam expanded beam contacts	53-55
c. Lumière (EN4531 – ELIO)	56
d. ARINC801	57
12. ACCESSORIES	58-59
13. GLOSSARY	60-61
14. CONTACT AND CABLE SELECTION GUIDE	62-67
a. COAXIAL CONTACTS	62-65
b. TWINAXIAL CONTACTS	66

INDEX

P/N	Pin or Socket	Type	Pages
140675	Pin	TWINAX Contact ABS 1600 AND ABS 1607	37
140683	Socket	TWINAX Contact ABS 1600 AND ABS 1607	37
250711	Socket	Thermo-couple	15
250712	Socket	Thermo-couple	15
600513	Pin	QUADRAX CONTACTS	43
600514	Pin	QUADRAX CONTACTS	43
600515	Socket	QUADRAX CONTACTS	43
600516	Socket	QUADRAX CONTACTS	43
600520	Socket	QUADRAX CONTACTS -PCB	45
600526	Socket	Signal contact LI	14
600580	Socket	RF Coaxial Contact	30
600581	Socket	RF Coaxial Contact	30
600600	Pin	RF Coaxial Contact	30
600606	Pin	RF Coaxial Contact	30
600611	Pin	TWINAX Contact - EN or ABS	36
600612	Pin	TWINAX Contact - EN or ABS	36
600613	Pin	TWINAX Contact - EN or ABS	36
600614	Socket	TWINAX Contact - EN or ABS	36
600615	Socket	TWINAX Contact - EN or ABS	36
600616	Socket	TWINAX Contact - EN or ABS	36
600659	Socket	Impedance Matched Coaxial Contact	24
600709	Socket	TWINAX - PCB	39
600715	Socket	75OHMS Coaxial Contact	31
600748	Socket	Shielded Coaxial contact CI	26
600749	Socket	Impedance Matched Coaxial Contact	26
600749	Piggy Back Grommet	75OHMS Coaxial Contact	31
600750	Socket	Impedance Matched Coaxial Contact	24
600757	Pin	75OHMS Coaxial Contact	31
600762	Piggy Back Grommet	75OHMS Coaxial Contact	31
600813	Pin	75OHMS Coaxial Contact	31
600822	Pin	75OHMS Coaxial Contact	32
600830	Pin	75OHMS Coaxial Contact	32
600836	Socket	75OHMS Coaxial Contact	32
600841	Socket	75OHMS Coaxial Contact	32
600850	Pin	TWINAX Contact - MIL	35
600851	Socket	TWINAX Contact - MIL	35
600854	Pin	TWINAX Contact - EN or ABS	36
600855	Socket	TWINAX Contact - EN or ABS	36
600856	Pin	TWINAX Contact - EN or ABS	36
600857	Socket	TWINAX Contact - EN or ABS	36
600858	Pin	TWINAX Contact - EN or ABS	36
600858	Pin	DIFFERENTIAL TWINAX CONTACTS	41
600859	Socket	TWINAX Contact - EN or ABS	36
600863	Pin	Power contact	16 17
600864	Pin	Power contact	16 17
600865	Socket	Power contact	16 17
600866	Socket	Signal contact LI	14
600867	Pin	Signal contact LI	14
600889	Pin	75OHMS Coaxial Contact - PCB	32
600899	Socket	DIFFERENTIAL TWINAX CONTACTS	41
600900	Pin	Shielded Coaxial contact	23
600901	Pin	Shielded Coaxial contact	23
600902	Pin	Shielded Coaxial contact	23
600903	Pin	Shielded Coaxial contact	23
600904	Pin	Shielded Coaxial contact	23
600905	Pin	Impedance Matched Coaxial Contact	24
600906	Pin	Impedance Matched Coaxial Contact	24
600907	Pin	Impedance Matched Coaxial Contact	24

P/N	Pin or Socket	Type	Pages
600907	Pin	Impedance Matched Coaxial Contact	24
600908	Pin	Impedance Matched Coaxial Contact	24
600909	Socket	75OHMS Coaxial Contact - PCB	32
600910	Socket	Shielded Coaxial contact	23
600911	Socket	Shielded Coaxial contact	23
600912	Socket	Shielded Coaxial contact	23
600913	Socket	Shielded Coaxial contact	23
600914	Socket	Shielded Coaxial contact	23
600915	Socket	Impedance Matched Coaxial Contact	24
600916	Socket	Impedance Matched Coaxial Contact	24
600917	Socket	Impedance Matched Coaxial Contact	24
600918	Socket	Impedance Matched Coaxial Contact	24
600919	Socket	RF Coaxial Contact	30
600920	Pin	RF Coaxial Contact	30
600921	Pin	RF Coaxial Contact	30
600922	Pin	RF Coaxial Contact	30
600923	Pin	RF Coaxial Contact	30
600924	Pin	RF Coaxial Contact	30
600925	Socket	RF Coaxial Contact	30
600926	Socket	RF Coaxial Contact	30
600927	Socket	RF Coaxial Contact	30
600929	Pin	RF Coaxial Contact	30
600930	Socket	RF Coaxial Contact	30
600931	Pin	DIFFERENTIAL TWINAX CONTACTS	41
600932	Socket	DIFFERENTIAL TWINAX CONTACTS	41
600933	Pin	DIFFERENTIAL TWINAX CONTACTS	41
600934	Socket	DIFFERENTIAL TWINAX CONTACTS	41
600935	Pin	DIFFERENTIAL TWINAX CONTACTS	41
600936	Socket	DIFFERENTIAL TWINAX CONTACTS	41
600938	Socket	DIFFERENTIAL TWINAX CONTACTS	41
600939	Pin	DIFFERENTIAL TWINAX CONTACTS	41
600940	Socket	DIFFERENTIAL TWINAX CONTACTS	41
600941	Pin	DIFFERENTIAL TWINAX CONTACTS	41
600942	Socket	DIFFERENTIAL TWINAX CONTACTS	41
600943	Pin	DIFFERENTIAL TWINAX CONTACTS	41
600944	Socket	DIFFERENTIAL TWINAX CONTACTS	41
600945	Pin	DIFFERENTIAL TWINAX CONTACTS	41
600946	Socket	DIFFERENTIAL TWINAX CONTACTS	41
600947	Pin	DIFFERENTIAL TWINAX CONTACTS	41
600948	Socket	DIFFERENTIAL TWINAX CONTACTS	41
600951	Pin	QUADRAX CONTACTS	43
600952	Socket	QUADRAX CONTACTS	43
600953	Pin	QUADRAX CONTACTS	43
600954	Socket	QUADRAX CONTACTS	43
600955	Pin	QUADRAX CONTACTS	43
600956	Socket	QUADRAX CONTACTS	43
600958	Socket	QUADRAX CONTACTS	43
600959	Pin	QUADRAX CONTACTS	43
600960	Socket	QUADRAX CONTACTS	43
600961	Pin	QUADRAX CONTACTS	43
600962	Socket	QUADRAX CONTACTS	43
600963	Pin	QUADRAX CONTACTS - EN	43
600964	Socket	QUADRAX CONTACTS - EN	43
600987	Pin	QUADRAX CONTACTS	43
603015	Piggy Back Grommet		58
603016	Piggy Back Grommet		58
603085	Pin	QUADRAX CONTACTS - EN	43
603086	Socket	QUADRAX CONTACTS - EN	43
603113	Pin	QUADRAX CONTACTS FOR ARINC600	46

P/N	Pin or Socket	Type	Pages
603116	Pin	QUADRAX CONTACTS FOR ARINC600	46
603160	Socket	Power contact	16 17
603161	Piggy Back Grommet	75OHMS Coaxial Contact	32
603177	Pin	QUADRAX CONTACTS FOR ARINC600 - PCB	46
603180	Socket	75OHMS Coaxial Contact	31
603209	Socket	QUADRAX CONTACTS FOR ARINC600	46
603210	Socket	QUADRAX CONTACTS FOR ARINC600	46
603228	Pin	QUADRAX CONTACTS FOR ARINC600 - PCB	46
603229	Socket	QUADRAX CONTACTS FOR ARINC600 - PCB	46
603247	Socket	Shielded Coaxial contact	22
900000	Pin	Signal contact	8 10
900001	Pin	Signal contact	8 10
900004	Pin	Signal contact	8 10 57
900005	Pin	Signal contact	8 10 57
900010	Socket	Signal contact	8 10
900011	Socket	Signal contact	8 10
900014	Socket	Signal contact	8 10
900020	SEALING PLUGS		58
900021	SEALING PLUGS		58
900022	SEALING PLUGS		58
900022	SEALING PLUGS		58
900023	SEALING PLUGS		58
900024	SEALING PLUGS		58
900025	DUMMY CONTACTS		58
900026	DUMMY CONTACTS		58
900028	DUMMY CONTACTS		58
900029	DUMMY CONTACTS		58
900040	Socket	Signal contact	8 10
900041	Socket	Signal contact	8 10
900044	Socket	Signal contact	8 10 59
900045	Socket	Signal contact	8 10
900048	Socket	Signal contact	8 10
900049	Pin	Signal contact	8 10
900075	Socket	Shielded Coaxial contact	22
900090	REDUCING FERRULE		59
900091	REDUCING FERRULE		59
900092	REDUCING FERRULE		59
900093	REDUCING FERRULE		59
900094	REDUCING FERRULE		59
900099	REDUCING FERRULE		59
900130	Pin	Shielded Coaxial contact	23
900135	Pin	Shielded Coaxial contact	23
900136	Pin	Shielded Coaxial contact	23
900137	Pin	Shielded Coaxial contact	23
900138	Pin	Shielded Coaxial contact	23
900140	Socket	Shielded Coaxial contact	23
900145	Socket	Shielded Coaxial contact	23
900146	Socket	Shielded Coaxial contact	23
900147	Socket	Shielded Coaxial contact	23
900148	Socket	Shielded Coaxial contact	23
900154	REDUCING FERRULE		59
900179	Pin	Shielded Coaxial contact CI	26
900183	DUMMY CONTACTS		58
900184	Pin	Shielded Coaxial contact CI	26 27
900186	Pin	Shielded Coaxial contact	62
900186	DUMMY CONTACTS		58
900187	Socket	Shielded Coaxial contact	21
900197	Pin	Power contact	16 59
900198	Pin	Power contact	16 59

INDEX

P/N	Pin or Socket	Type	Pages
900210	Pin	QUADRAX CONTACTS -PCB	45
900217	Socket	Power contact	16 59
900238	Pin	Signal contact CI	14
900240	Pin	Signal contact CI	14
900241	Pin	Signal contact CI	14
900243	Pin	Signal contact LI	14
900245	Pin	Signal contact CI	14
900246	Pin	Signal contact LI	14
900251	Socket	Signal contact CI	14
900252	Socket	Signal contact LI	14
900256	Socket	Signal contact CI	14
900263	Socket	Signal contact CI	14
900286	Socket	Shielded Coaxial contact	21
900294	Pin	DIFFERENTIAL TWINAX CONTACTS	41
900299	Socket	DIFFERENTIAL TWINAX CONTACTS	41
900309	Pin	Shielded Coaxial contact	41 22
900310	Socket	Shielded Coaxial contact	41
900310	Socket	Shielded Coaxial contact	22
900317	Pin	Signal contact	8 10
900318	Pin	Signal contact	8 10
900319	Pin	Signal contact	8 10
900320	Pin	Signal contact	8 10
900322	Socket	Signal contact	8 10
900323	Socket	Signal contact	8 10
900324	Socket	Signal contact	8 10
900325	Socket	Signal contact	8 10
900327	Pin	QUADRAX CONTACTS	43
900329	DUMMY CONTACTS		58
900330	Pin	QUADRAX CONTACTS	43
900332	DUMMY CONTACTS		58
900337	Socket	QUADRAX CONTACTS	43
900338	Socket	QUADRAX CONTACTS	43
900340	Pin	Shielded Coaxial contact	21 22
900341	Pin	Shielded Coaxial contact	21 22
900350	Socket	Shielded Coaxial contact	22
900351	Socket	Shielded Coaxial contact	22
900354	Socket	Shielded Coaxial contact	21
900361	Socket	QUADRAX CONTACTS	43
900384	Pin	Impedance Matched Coaxial Contact	24
900385	Pin	Impedance Matched Coaxial Contact	24
900389	Pin	Signal contact LI	14
900395	Socket	Impedance Matched Coaxial Contact	24
900403	Socket	Signal contact CI	14
900405	Socket	Shielded Coaxial contact CI	26 27
900409	Pin	Shielded Coaxial contact LI	26
900410	Pin	QUADRAX CONTACTS	43
900411	Socket	QUADRAX CONTACTS	43
900412	Socket	Impedance Matched Coaxial Contact	26
900413	Pin	Signal contact LI	14
900418	Pin	DIFFERENTIAL TWINAX CONTACTS	41
900419	Socket	DIFFERENTIAL TWINAX CONTACTS	41
900420	Socket	Shielded Coaxial contact	21
900421	Socket	Shielded Coaxial contact	22
900422	Socket	Shielded Coaxial contact	22
900423	Socket	Signal contact LI	14
900424	Pin	Shielded Coaxial contact	21 22
900425	Socket	Shielded Coaxial contact	21
900426	Pin	Shielded Coaxial contact	21 22
900427	Socket	Shielded Coaxial contact	21
900428	Pin	Shielded Coaxial contact	21 22
900429	Socket	Shielded Coaxial contact	21
900430	Socket	Shielded Coaxial contact	22

P/N	Pin or Socket	Type	Pages
900458	Pin	Signal contact CI	14
900459	Socket	Signal contact CI	14
900471	Piggy Back Grommet		16
900472	Piggy Back Grommet		16 32 56
900476	Piggy Back Grommet		58
900488	DUMMY CONTACTS		58
900489	Pin	Shielded Coaxial contact LI	26
900496	Pin	QUADRAX CONTACTS	43
900928	Socket	RF Coaxial Contact	30
900937	Pin	DIFFERENTIAL TWINAX CONTACTS	41
922390	Socket	Signal contact LI	14
60020802	Socket	Signal contact	8 10
60023302	Pin	Signal contact	8 10
60087001	Socket	Signal contact	12 13
60087101	Socket	Signal contact	12 13
60087201	Socket	Signal contact	12 13
60087301	Socket	Signal contact	12 13
60087401	Socket	Signal contact	12 13
60087501	Socket	Signal contact	12 13
60087601	Socket	Signal contact	12 13
60087701	Socket	Signal contact	12 13
60088001	Pin	Signal contact	12 13
60088002	Pin	Signal contact	8 10
60088101	Pin	Signal contact	12 13
60088201	Pin	Signal contact	12 13
60088202	Pin	Signal contact	8 10
60088301	Pin	Signal contact	12 13
60088401	Pin	Signal contact	12 13
60088402	Pin	Signal contact	8 10
60088501	Pin	Signal contact	12 13
60088601	Pin	Signal contact	12 13
60088602	Pin	Signal contact	8 10
60088701	Pin	Signal contact	12 13
60089001	Socket	Signal contact	12 13
60089002	Socket	Signal contact	8 10
60089101	Socket	Signal contact	12 13
60089201	Socket	Signal contact	12 13
60089202	Socket	Signal contact	8 10
60089301	Socket	Signal contact	12 13
60089401	Socket	Signal contact	12 13
60089402	Socket	Signal contact	8 10
60089501	Socket	Signal contact	12 13
60089601	Socket	Signal contact	12 13
60089602	Socket	Signal contact	8 10
60089701	Socket	Signal contact	12 13
050741	Socket	SPLIT PAIR QUADREX CONTACTS	48
050742	Pin	SPLIT PAIR QUADREX CONTACTS	48
050998	Pin	QUADRAX CONTACTS	43
050999	Socket	QUADRAX CONTACTS	43
070247	Pin	Shielded Coaxial contact	21 22 56
070248	Socket	Shielded Coaxial contact	22
070586	Pin	Thermo-couple	15
070587	Pin	Thermo-couple	15
071094	Pin	Shielded Coaxial contact	21 22
071315	Socket	Signal contact	8 10
071954	Pin	Shielded Coaxial contact	21 22
071965	Socket	Shielded Coaxial contact	22
071998	Socket	Shielded Coaxial contact	21
072265	Pin	TWINAX - PCB	39
072453	Socket	TWINAX Contact - MIL	35
072500	Socket	Thermo-couple	15
072501	Pin	Thermo-couple	15
072502	Pin	Thermo-couple	15

P/N	Pin or Socket	Type	Pages
072503	Socket	Thermo-couple	13
074834	Pin	TWINAX Contact - MIL	33
076588	Socket	TWINAX Contact 1760 interface	35
076589	Socket	TWINAX Contact 1760 interface	35
076590	Pin	TWINAX Contact - 1760 interface	35
076915	Pin	TWINAX Contact 1760 interface	35
077516	Socket	TWINAX Contact 1760 interface	35
077517	Pin	TWINAX Contact 1760 interface	35
077987	Socket	Shielded Coaxial contact	19

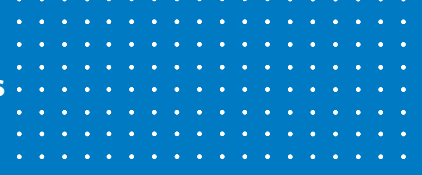

DESIGN

Amphenol Socapex drives innovation through products since years. Thanks to our localization in the Arves valley and our integrated organization, Amphenol acquires a strong knowledge on design and manufacturing of contacts. Our team can support customer requests and offer the right design for the right application.

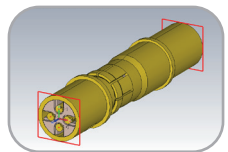
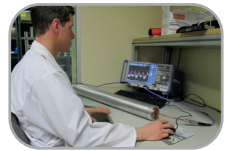
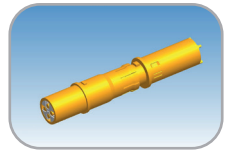

QUICK FACTS

- ProEngineer software link to a mechanical software analysis
- CST software to characterize high speed contacts
- Engineering laboratory for:
 - Mechanical measurements

SCREW MACHINING OPERATIONS

Our screw machining operations based in Theyez work independently. They manage both internal requests for Amphenol and demands from outside companies.

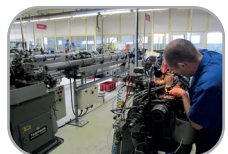

QUICK FACTS

- A park for all series from 1 to 100 000 pieces, and more. Maximal diameter workable: 10mm
- Machined parts with slots, milling, axial holes, radial or eccentric holes, thread, tapping, contacts with wire wrap terminations and winchester.
- Deburring and polishing by tribofinishing or dry sand blasting.
- Heat treatment under controlled atmosphere (beryllium copper). Local induction annealing on contacts.
- Standard metal on stock: beryllium copper, brass, brass for crimping, steel, stainless steel.
- Capability to have a combined project with plating including cadmium plating, electroless nickel-plating, nickel + gold plating, silver plating, tin plating, passivating for stainless steel.
- Quick turn-around: quick delivery for small quantities.

PLATING CAPABILITIES

Amphenol Socapex provides you with plating services for a wide range of pieces such as connectors, contacts, boxes and accessories.

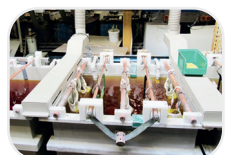

Our plating services include:

- cadmium plating
- chemical nickel (medium and high phosphorous)
- copper, nickel, silver and gold plating
- passivation of stainless steel
- substitutes treatment plating to ROHS cadmium

These treatments can be done in rack, barrel, vibratory bowl-feeder, reel to reel for stamped and formed contacts.

To guarantee the best quality, we utilize different control methods:

- X-ray measurement for thickness
- binocular microscope for aspect
- salt spray chamber for testing corrosion
- chemical laboratory for the follow-up of the baths and the development of new processes.

Our workshop is accredited by many OEMs such as MBDA, Aérazur, Safran...

The plating is made in compliance with environmental norms, our factory is certified ISO 14001.

PRODUCT DESIGNATION AND DERIVATED PRODUCTS

In this catalog, Amphenol refers only on standard designations for the contacts usages. This page is a guide to help finding all the Amphenol compliant products behind the standard designation

Design
Screw machining operations
Plating capabilities



MIL-DTL-38999 SERIES I

- Amphenol proprietary : LJT series (please refer catalog DOC-000031-ANG)
- Rack & Panel derived product:
 - RNJ series (please refer catalog E115)



MIL-DTL-38999 SERIES II

- Amphenol proprietary : JT series (please refer catalog E 111)
- Quick release derived product: SC39LP (please refer DOC-000637-ANG)



MIL-DTL-38999 SERIES III / EN3645

- Amphenol proprietary: TV / CTV series (please refer DOC-000035-ANG)
- Rack & Panel derived product:
 - RNJLP series (please refer catalog E124)
 - Quick release derived product: SC39 (please refer DOC-000637-ANG)



For more information, please visit our website: www.38999-solutions.com

SIGNAL CONTACTS

CRIMP CONTACTS

MIL-DTL-38999 SERIES I, II,III / EN3645 / EN4165

Amphenol contacts are designed to meet and exceed SAE39029 and EN3155 standards. The following contacts are gold plating over suitable underplate. They withstand 500 and 1500 cycles. The 1500 cycles contacts are dedicated to MIL-DTL-38999 series III classes H and J.



SAE39029 CONTACTS - US MIL STANDARD

500 CYCLES

PIN or SOCKET	MILITARY Nb	CONTACT		AMPHENOL P/N	Color bands			CONNECTOR				
		Mating end size	Wire barrel size		Wire barrel			MIL-DTL-38999			EN3645	EN4165
					1st	2nd	3rd	S I	S II	S III		
P	M39029/18-177	23	22	900049	Orange	Blue	Black			X	X	X
	M39029/58-360	22	22D	900004	Orange	Blue	Black	X	X	X	X	X
	M39029/58-363	20	20	900001	Orange	Blue	Black	X	X	X	X	X
	M39029/58-364	16	16	900000	Orange	Blue	Black	X	X	X	X	X
	M39029/58-365	12	12	900005	Orange	Blue	Black	X	X	X	X	X
S	M39029/17-172	23	22	900048	Orange	Blue	Black			X	X	
	M39029/56-348	22	22D	900044	Orange	Blue	Black	X		X	X	
	M39029/57-354	22	22D	900014	Orange	Blue	Black		X			
	M39029/56-351	20	20	900041	Orange	Blue	Black	X		X	X	
	M39029/57-357	20	20	900011	Orange	Blue	Black		X			
	M39029/56-352	16	16	900040	Orange	Blue	Black	X		X	X	
	M39029/57-358	16	16	900010	Orange	Blue	Black		X			
	M39029/56-353	12	12	900045	Orange	Blue	Black	X		X	X	
	M39029/57-359	12	12	071315	Orange	Blue	Black		X			



Contacts size 23 are dedicated to HD38999 Amphenol connectors.

SAE39029 CONTACTS

ENHANCED PERFORMANCES

QUALIFICATION IN PROGRESS

PIN or SOCKET	MILITARY Nb	CONTACT		AMPHENOL P/N	Color bands			CONNECTOR				
		Mating end size	Wire barrel size		Wire barrel			MIL-DTL-38999			EN3645	EN4165
					1st	2nd	3rd	S I	S II	S III		
P	AS39029/122-669	23	26	/	Blue	Blue	Black			X		
	AS39029/122-670	23	22	/	Blue	Blue	Black			X		
	AS39029/122-671	22	22D	60088002	Blue	Blue	Black	X	X	X	X	X
	AS39029/122-672	20	20	60088202	Blue	Blue	Black	X	X	X	X	X
	AS39029/122-673	16	16	60088402	Blue	Blue	Black	X	X	X	X	X
	AS39029/122-674	12	12	60088602	Blue	Blue	Black	X	X	X	X	X
S	AS39029/122-675	10	10	60023302	Blue	Blue	Black	X	X	X		
	AS39029/121-662	23	26	/	Blue	Blue	Black			X		
	AS39029/121-663	23	22	/	Blue	Blue	Black			X		
	AS39029/121-664	22	22D	60089002	Blue	Blue	Black	X		X	X	
	AS39029/121-665	20	20	60089202	Blue	Blue	Black	X		X	X	
	AS39029/121-666	16	16	60089402	Blue	Blue	Black	X		X	X	
	AS39029/121-667	12	12	60089602	Blue	Blue	Black	X		X	X	
AS39029/121-668	10	10	60020802	Blue	Blue	Black	X		X			

SIGNAL CONTACTS

CRIMP CONTACTS

MIL-DTL-38999 SERIES I, II,III / EN3645 / EN4165

SAE39029 CONTACTS











1500 CYCLES

PIN or SOCKET	MILITARY Nb	CONTACT		AMPHENOL P/N	Color bands			CONNECTOR			
		Mating end size	Wire barrel size		Wire barrel			MIL-DTL-38999			EN3645
					1st	2nd	3rd	S I	S II	S III	
P	M39029/107-620	22	22D	900317	Blue	Red	Black			X	X
	M39029/107-621	20	20	900318	Blue	Red	Brown			X	X
	M39029/107-622	16	16	900319	Blue	Red	Red			X	X
	M39029/107-623	12	12	900320	Blue	Red	Orange			X	X
S	M39029/106-614	22	22D	900322	Blue	Brown	Yellow			X	X
	M39029/106-615	20	20	900323	Blue	Brown	Green			X	X
	M39029/106-616	16	16	900324	Blue	Brown	Blue			X	X
	M39029/106-617	12	12	900325	Blue	Brown	Purple			X	X

SAE39029 WIRE BARREL RANGE AND NOMINAL TEST CURRENT (A)

Wire barrel size	Wire Size								
	12	14	16	18	20	22	24	26	28
22						5	3	2	1.5
22D						5	3	2	1.5
20					7.5	5	3		
16			13	10	7.5				
12	23	17							

COLOR BAND

	Orange
	Brown
	Violet
	Blue
	Green
	Black
	Yellow
	Red
	Gray
	White

SIGNAL CONTACTS

Signal Contacts

CRIMP CONTACTS MIL-DTL-38999 SERIES I, II,III / EN3645 / EN4165



SAE 39029 CRIMPING TOOLS

PIN or SOCKET	MILITARY Nb	CONTACT		Amphenol P/N	Crimping Tool	
		Mating end size	Wire barrel size		Crimping Tool	Positionner
P	M39029/18-177	23	22	900049	M22520/2-01	M22520/2-13
	M39029/58-360	22	22D	900004	M22520/2-01	M22520/2-09
	M39029/58-363	20	20	900001	M22520/2-01	M22520/2-10
					M22520/1-01	M22520/1-04
	M39029/58-364	16	16	900000	M22520/1-01	M22520/1-04
	M39029/58-365	12	12	900005	M22520/1-01	M22520/1-04
S	M39029/17-172	23	22	900048	M22520/2-01	M22520/2-16
	M39029/56-348	22	22D	900044	M22520/2-01	M22520/2-07
	M39029/57-354	22	22D	900014	M22520/2-01	M22520/2-06
					M22520/2-01	M22520/2-10
	M39029/56-351	20	20	900041	M22520/1-01	M22520/1-04
					M22520/2-01	M22520/2-10
	M39029/57-357	20	20	900011	M22520/1-01	M22520/1-04
					M22520/2-01	M22520/2-10
	M39029/56-352	16	16	900040	M22520/1-01	M22520/1-04
	M39029/57-358	16	16	900010	M22520/1-01	M22520/1-04
	M39029/56-353	12	12	900045	M22520/1-01	M22520/1-04
	M39029/57-359	12	12	071315	M22520/1-01	M22520/1-04

QUALIFICATION IN PROGRESS

PIN or SOCKET	MILITARY Nb	CONTACT		Amphenol P/N	Crimping Tool	
		Mating end size	Wire barrel size		Crimping Tool	Positionner
P	AS39029/122-669	23	26	/	M22520/2-01	M22520/2-16
	AS39029/122-670	23	22	/	M22520/2-01	M22520/2-16
	AS39029/122-671	22	22D	60088002	M22520/2-01	M22520/2-09
					M22520/7-01	M22520/7-07
	AS39029/122-672	20	20	60088202	M22520/1-01	M22520/2-10
					M22520/7-01	M22520/7-08
					M22520/1-01	M22520/1-04
	AS39029/122-673	16	16	60088402	M22520/1-01	M22520/1-04
M22520/7-01					M22520/7-04	
AS39029/122-674	12	12	60088602	M22520/1-01	M22520/1-04	
AS39029/122-675	10	10	60023302	M22520/45-04	Basic tool	
S	AS39029/122-662	23	26	/	M22520/2-01	M22520/2-16
	AS39029/122-663	23	22	/	M22520/2-01	M22520/2-16
	AS39029/122-664	22	22D	60089002	M22520/2-01	M22520/2-07
					M22520/7-01	M22520/7-05
	AS39029/122-665	20	20	60089202	M22520/2-01	M22520/2-10
					M22520/7-01	M22520/7-08
					M22520/1-01	M22520/1-04
	AS39029/122-666	16	16	60089402	M22520/1-01	M22520/1-04
M22520/7-01					M22520/7-04	
AS39029/122-667	12	12	60089602	M22520/1-01	M22520/1-04	
AS39029/122-668	10	10	60020802	M22520/45-01	Basic tool	

SIGNAL CONTACTS

CRIMP CONTACTS MIL-DTL-38999 SERIES I, II,III / EN3645 / EN4165

SAE 39029 CRIMPING TOOLS

PIN or SOCKET	MILITARY Nb	CONTACT		Crimping Tool	
		Mating end size	Wire barrel size	Crimping Tool	Positionner
P	M39029/107-620	22	22D	M22520/2-01	M22520/2-13
	M39029/107-621	20	20	M22520/2-01	M22520/2-10
				M22520/1-01	M22520/1-04
	M39029/107-622	16	16	M22520/2-01	M22520/2-10
M39029/107-623	12	12	M22520/1-01	M22520/1-04	
S	M39029/106-614	22	22D	M22520/1-01	M22520/1-04
	M39029/106-615	20	20	M22520/2-01	M22520/2-10
				M22520/1-01	M22520/1-04
	M39029/106-616	16	16	M22520/2-01	M22520/2-16
M39029/106-617	12	12	M22520/2-01	M22520/2-07	

SIGNAL CONTACTS

Signal Contacts



CRIMP CONTACTS
MIL-DTL-38999 SERIES I, II, III /
EN3645 / EN4165

EN3155 CONTACTS - EUROPEAN STANDARD

PIN or SOCKET	EN3155	CONTACT		AMPHENOL P/N	Color bands		CONNECTOR				
		Mating end size	Wire barrel size		Wire barrel		MIL-DTL-38999			EN3645	EN4165
					1st	2st	S I	S II	S III		
P	EN3155-008	22	22	60088001	Green	Green	X	X	X	X	X
		20	22	60088101	Green	Red	X	X	X	X	X
		20	20	60088201	Red	Red	X	X	X	X	X
		20	18	60088301	Brown	Red	X	X	X	X	X
		16	16	60088401	Blue	Blue	X	X	X	X	X
		16	14	60088501	White	Blue	X	X	X	X	X
		12	12	60088601	Yellow	Yellow	X	X	X	X	X
S	EN3155-003	22	22	60087001	Green	Green		X			X
		20	22	60087101	Green	Red		X			X
		20	20	60087201	Red	Red		X			X
		20	18	60087301	Brown	Red		X			X
		16	16	60087401	Blue	Blue		X			X
		16	14	60087501	White	Blue		X			X
		12	12	60087601	Yellow	Yellow		X			X
	12	14	60087701	White	Yellow		X			X	
	EN3155-009	22	22	60089001	Green	Green	X		X	X	
		20	22	60089101	Green	Red	X		X	X	
		20	20	60089201	Red	Red	X		X	X	
		20	18	60089301	Brown	Red	X		X	X	
		16	16	60089401	Blue	Blue	X		X	X	
		16	14	60089501	White	Blue	X		X	X	
12		12	60089601	Yellow	Yellow	X		X	X		
		12	14	60089701	White	Yellow	X		X	X	

EN3155 WIRE BARREL RANGE AND NOMINAL TEST CURRENT (A)

Wire barrel size	Wire Size								
	12	14	16	18	20	22	24	26	28
22						5	3	2	
20					7.5	5	3		
18				7.5	7.5	5	3		
16			13	10	7.5				
14		13	13	10	7.5				
12	23	17							

HOW TO BUILD EN3155 REFERENCE

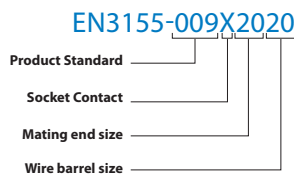
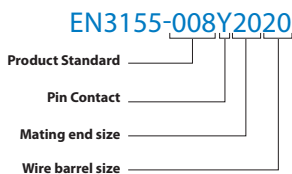

SIGNAL CONTACTS

CRIMP CONTACTS

MIL-DTL-38999 SERIES I, II,III / EN3645 / EN4165

EN3155 CRIMPING TOOLS

PIN or SOCKET	EN3155	CONTACT		Amphenol P/N	Crimping Tool	
		Mating end size	Wire barrel size		Crimping Tool	POSITIONNER
P	EN3155-008	22	22	60088001	M22520/2-01	M22520/2-09
		20	22	60088101	M22520/2-01	M22520/2-10
					M22520/1-01	M22520/1-04
		20	20	60088201	M22520/2-01	M22520/2-10
					M22520/1-01	M22520/1-04
		20	18	60088301	M22520/2-01	M22520/2-10
					M22520/1-01	M22520/1-04
		16	16	60088401	M22520/1-01	M22520/1-04
16	14	60088501	M22520/1-01	M22520/1-04		
12	12	60088601	M22520/1-01	M22520/1-04		
12	14	60088701	M22520/1-01	M22520/1-04		
S	EN3155-003	22	22	60087001	M22520/2-01	M22520/2-06
		20	22	60087101	M22520/2-01	M22520/2-10
					M22520/1-01	M22520/1-04
		20	20	60087201	M22520/2-01	M22520/2-10
					M22520/1-01	M22520/1-04
		20	18	60087301	M22520/2-01	M22520/2-10
					M22520/1-01	M22520/1-04
		16	16	60087401	M22520/1-01	M22520/1-04
	16	14	60087501	M22520/1-01	M22520/1-04	
	12	12	60087601	M22520/1-01	M22520/1-04	
	12	14	60087701	M22520/1-01	M22520/1-04	
	EN3155-009	22	22	60089001	M22520/2-01	M22520/2-07
		20	22	60089101	M22520/2-01	M22520/2-10
					M22520/1-01	M22520/1-04
		20	20	60089201	M22520/2-01	M22520/2-10
					M22520/1-01	M22520/1-04
20		18	60089301	M22520/2-01	M22520/2-10	
				M22520/1-01	M22520/1-04	
16		16	60089401	M22520/1-01	M22520/1-04	
16	14	60089501	M22520/1-01	M22520/1-04		
12	12	60089601	M22520/1-01	M22520/1-04		
12	14	60089701	M22520/1-01	M22520/1-04		

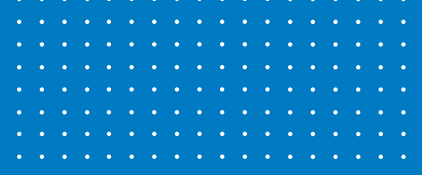

SIGNAL CONTACTS

SIGNAL CONTACTS

PCB CONTACTS

MIL-DTL-38999 SERIES I, III / EN3645 / EN4165

PIN or SOCKET	Mating end size	TYPE	AMPHENOL P/N	TYPE	AMPHENOL P/N
P	23	CI	900458	LI	600867
	22D		900245		922389
	20		900241		900243
	16		900240		900246
	12		900238		900282
S	23		900459		600866
	22D		900256		922390
	20		900251		900252
	16		900263		600526
	12		900403		

Pin 900245, Socket 900256

Connectors with PCB Contacts		MIL-DTL-38999 series I		SJT		MIL-DTL-38999 series II			MIL-DTL-38999 series III / EN3645			MIL-DTL-38999 series III / EN3645 composite						
		Sizes	9 to 17	19 to 25	8 to 16	18 to 24	8 to 18	20 to 22	24	9 to 11	13	15 to 17	19 to 25	9 to 11	13 to 25			
	Pin	L1	8,7 - 9,7		13,8 - 14,8		12,3 - 13,2		11,6 - 12,6		10,1 - 11,1		10 - 10,9		10,1 - 11,1	10 - 10,9		
		L2	1,1 - 2,1	0,7 - 1,7		1,2 - 2,4	0,4 - 1,6		5,1 - 5,9		3,3 - 4,2		1 - 1,9		1 - 1,8	1 - 1,9		
	Socket	L1	8,5 - 9,5		13,6 - 14,6		12,1 - 13		11,4 - 12,4		9,9 - 10,9		9,8 - 10,7		9,9 - 10,9		9,8 - 10,7	
		L2	0,9 - 1,9	0,5 - 1,5		1 - 2,2	0,2 - 1,4		4,9 - 5,7		3,1 - 4,0		0,8 - 1,7		0,8 - 1,6	0,8 - 1,7		
	Pin	L1	13,7 - 14,6		13,8 - 14,6		/			9 to 25			9 to 19		21 to 25			
		L2	1,6 - 2,6		1,6 - 2,6	0,3 - 1,2				9,3 - 10,1			9,3 - 10,2		9,4 - 10,3			
	Socket	L1	13,5 - 14,4		13,6 - 14,4					1 - 2			1 - 1,9		9,1 - 10		9,2 - 10,1	
		L2	1,4 - 2,4		1,4 - 2,4	0,1 - 1				0,8 - 1,8			0,8 - 1,7		0,8 - 1,7			
	Pin	L1	11,3 - 12,1	12,1 - 12,9	15,4 - 16,2	11,8 - 12,6	8 to 22		24	9 to 19		21 to 25		9 to 19		21 to 25		
		L2	1,3 - 2,2		2,7 - 3,7	0 - 0,9		4,6 - 5,5		3,3 - 4,2		1 - 2		1 - 1,9		12,2 - 13		
	Socket	L1	11,1 - 11,9	11,9 - 12,7	15,2 - 16	11,6 - 12,4	12 - 12,8		11,3 - 12,2		12,1 - 13		12,6 - 13,4		13,4 - 14,2			
		L2	1,1 - 2		2,5 - 3,5	0 - 0,7		4,4 - 5,3		3,1 - 4		0,8 - 1,8		0,8 - 1,7				
	Pin	L1	/		4,5 - 5,3	0,9 - 1,7	8 to 24		9 to 19		21 to 25		/					
		L2			1 - 2	/	6,8 - 7,8		6,8 - 7,8									
	Socket	L1			4,2 - 5,1	0,7 - 1,5	12 - 12,8		11,3 - 12,2		12,1 - 13							
		L2			0,8 - 1,8	/	6,6 - 7,6		6,6 - 7,6									

SIGNAL CONTACTS

THERMO COUPLE CONTACTS

MIL-DTL-38999 SERIES I, II,III / EN3645 / EN4165

AMPHENOL thermocouples contacts are designed to keep the signal transmission of thermocouples wires. They meet or exceed SAE 39029 standards

EN3155 BIN CODES

PIN or SOCKET	AMPHENOL P/N	MILITARY Nb	CONTACT		Color bands			CLASS
			Mating end size	Wire barrel size	Wire barrel end			
					1st	2nd	3rd	
P	072502	M39029/87-471	22	22D	Yellow	Blue	Red	ALUMEL
	072501	M39029/87-472	22	22D	Yellow	Blue	Red	CHROMEL
	070586	M39029/87-475	20	20	Yellow	Blue	Green	ALUMEL
	070587	M39029/87-476	20	20	Yellow	Blue	Blue	CHROMEL
		M39029/87-479	16	16	Yellow	Blue	White	ALUMEL
		M39029/87-480	16	16	Yellow	Grey	Black	CHROMEL
S	072500	M39029/88-484	22	22D	Yellow	Grey	Yellow	CHROMEL
	072503	M39029/88-483	22	22D	Yellow	Grey	Orange	ALUMEL
	250711	M39029/88-488	20	20	Yellow	Grey	White	CHROMEL
	250712	M39029/88-487	20	20	Yellow	Grey	Purple	ALUMEL
		M39029/88-492	16	16	Yellow	White	Red	CHROMEL
		M39029/88-491	16	16	Yellow	White	Brown	ALUMEL



For other thermocouple class as Iron or Constantan, please consult us.

PRINT CIRCUIT BOARD CONTACTS

- Amphenol Socapex can design specific Print Circuit Board pin contacts for thermocouple application. Please consult us.
- Amphenol Socapex has a wide range of thermo-couple contacts.

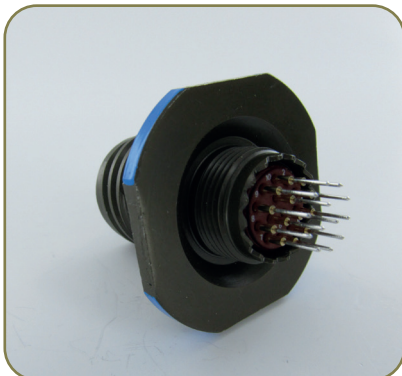

POWER CONTACTS

SIZE 8 CONTACTS

MIL-DTL-38999 SERIES III / EN3645 / EN4165

Amphenol has a large experience in power generation contact, and has developed some technologies dedicated to power in order to reduce heating, save space, as well as increasing the durability



Pin or socket	EN3155	Contact		Amphenol P/N	Color bands Wire barrel		Crimping Tools	Piggy Back Grommet
		Mating end size	Wire barrel size		1st	2st		
P	EN3155-065	8	8	600863			See page 17	900471
		8	10	600864				900472
S	EN3155-083	8	8	603160				900471
		8	10	600865				900472



The standard EN3155-066 has been superseded by EN3155-083

Pin or socket	Contact		Amphenol P/N	Crimping Tool	Piggy Back Grommet
	Mating end size	Wire barrel size			
P	8	8	900197	M300-BT with SP593	900471
			900198		
S	8	8	900217		
M300-BT is supplied by DMC Tools					



The contact 900198 is only compliant with 21-48 connector

CONTACT PERFORMANCES

MECHANICAL

- Endurance: 500 mating/unmating
- Shock & vibrations: As per EN3645 /MIL-DTL-38999

ELECTRICAL

- Max Current rating: 46A (8 8); 33A (8 10)

ENVIRONMENTAL

- Temperature : -65°C +200°C

POWER CONTACTS

CRIMPING TOOLS

Pin or socket	EN3155	Contact		Amphenol P/N	Crimping Tool			
		Mating end size	Wire barrel size		Automatic tool M22520/23-01		Manual tool M300BT	
					Die Set	Locator	Locator	Selector
P	EN3155-065	8	8	600863	WA23-264DA	WA23-447L	SP593	4
		8	10	600864			SP593	3
S	EN3155-083	8	8	603160			SP593	4
		8	10	600865			SP593	3

Automatic tool			Manual hand tool	
				
Crimping tool M22520/23-01	Die Set	Locator	Crimping tool M300BT	Locator

38999 TYPE 21-48 - 4X60 AMPS CIRCULAR POWER CONNECTOR

- The Amphenol Socapex power connector 38999 type 21-48 provides 4 size 8 power contacts in a size 21 shell in accordance with the MIL-DTL-38999 Series I standard. This arrangement was originally developed for military applications. Due to the rigidity of the cables used, the front male insulator has been reinforced to maintain a perfect alignment of contacts during mating.
- A header is placed in the backshell to guide each wire and to guarantee tightness even when cables are bent.
- Available in TV-CTV (Mil-DTL-38999 Series III).

Please refer to catalog E117

4X100A - CIRCULAR POWER



- This power connector from Amphenol LJT 25-1A was originally developed for military applications. Indeed, it is used in the conditioning of tanks.
- This connector has the particularity to provide 4 size 4 power contacts and 4 size 16 contacts in a size 25 shell in accordance with the MIL-C-38999 Series 1 standard.
- Available in TV-CTV

Please refer to catalog E116

POWER CONTACTS

SPECIFIC RANGE OF PRODUCTS

AMPHENOL RADSOK TECHNOLOGY

The RADSOK® High Amperage Electrical Terminal benefits the user from engineering, quality, and manufacturing viewpoints.

RADSOK® technology is based upon a stamped and formed flat grid, twisted into a hyperbolic shape to provide secure and robust contact to the mating pin's contact surface. Most Pin and Socket technologies rely upon spring (compressive) properties of the contact elements, which may weaken over time. Unlike other Pin and Socket solutions, the RADSOK® also utilizes the tensile strength properties of the flat stamped, copper alloy grid to provide high normal forces with a large socket-to-pin conductive surface area.

This design provides a correspondingly low voltage drop and low temperature rise. Other tensile design products use round wires (instead of flat bands) in the hyperbolic shape, this significantly reduces the contact surface between pin and socket.

Proven by millions of parts in the field, a RADSOK® electrical connection is economical and extremely reliable, with zero reported failures in properly designed applications. RADSOK® technology benefits can be summarized as:

- **HIGH RELIABILITY**

Unique RADSOK® design and construction technology create an electrical contact interface that exceeds typical interconnect requirements. Applications in aerospace, medical, industrial, automotive, mining, offshore, and other harsh environments depend on high reliability of the Amphenol RADSOK® technology.

- **LOW CONTACT ENGAGEMENT/SEPARATION FORCES**

The hyperbolic lamella socket contact construction distributes normal forces over a high percentage of the mating pin surface. This creates a smooth, even engagement effort. This force distribution also contributes to excellent performance in vibration applications with resistance to typical fretting corrosion.

- **LOW CONTACT RESISTANCE**

The large interface area between the socket lamella and pin surface result in very low contact resistance, enabling the RADSOK® contacts' high current ratings compared to traditional power contact designs.

- **HIGH MATING CYCLE DURABILITY**

RADSOK® contacts with typical silver plating finishes have demonstrated survival of 20,000 mating cycles. Specialized plating and contact lubricants can extend cycle life to 200,000 matings or higher. Even with continuous exposure to harsh environmental abuse (salt, sand, and high humidity), RADSOK® contacts have been tested to maintain low contact resistance beyond 10,000 mating cycles.

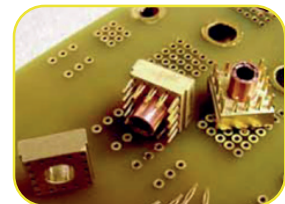

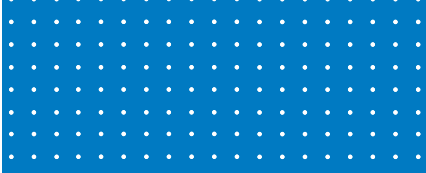

NOTES

A series of horizontal dotted lines for taking notes, spanning most of the page width.

Power Contacts



SHIELDED COAXIAL CONTACT

These contacts are required for high frequency interconnection. High speed Coax contacts within a connector provide the shielding protection in order to eliminate interferences from outside electrical sources, and many cases the RF/Microwave performance needed in the circuitry of many applications.

FEATURES AND BENEFITS

- Large crimping area assures low contact resistance and high tensile strength
- Back insulator provides closed entry for socket inner contact against axial loads
- Front insulator provides closed entry for socket inner contact
- Recessed inner contact is protected
- Outer contact has rugged wall section for durability

MATERIALS AND FINISH

- Body: Copper alloy
- Finish: Gold over nickel on mating parts
- Insulators: High Performance Fluorocarbon

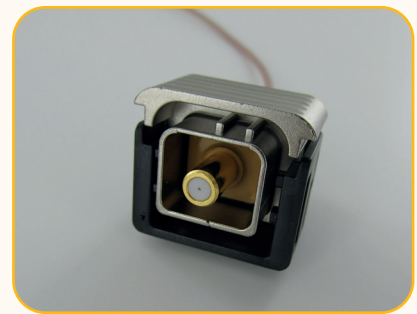

TYPICAL COAXIAL CABLE

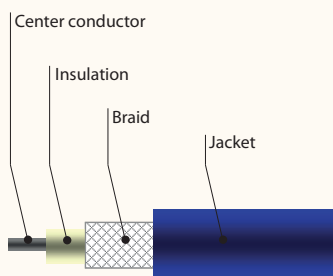

? GUIDELINE TO CHOOSE THE RIGHT COAXIAL CONTACT

Choose the contact application :

Standard Frequency, High Frequency or very high Frequency

- Standard Frequency: Non Impedance Matched Contacts (VSWR: 1.5:1)
- High Frequency: Impedance Matched Contacts (VSWR: 1.2:1 +.04F (GHz) up to 3GHz)
- Very High Frequency: BMA / BMZ Interface contacts

Check the cable diameter versus the contact size :

- Sometimes we can use a smaller contact
- Sometimes the wire is bigger than the contact



For more details, please refer contact and cable selection guides at page 56

SHIELDED COAXIAL CONTACT

MIL-DTL-38999 SERIES II
EN4165 SERIES

INTERFACE AND QUALIFICATION : SAE AS39029 / 27,28,76,78

Contact Size	Cable	Contact Part Number				Crimping Tools	
		Pin		Socket		Inner contact	Crimp ferrule
		Proprietary	Standard	Proprietary	Standard		
16	RG-178B/U, RG-196A/U	070575	M39029/76-425	070574	M39029/78-433	M22520/2-01 with Positioner M22520/2-35 or with Daniels Positioner K532	M22520/4-01 with Positioner M22520/4-02
	HAVEG 30-00761, 30-02024, 30-02033 TENSOLITE 24713/A955KK1, 26723/A955KK1	900309		900310			
	HAVEG 61-02051	900186		900187			
	RG-174A/U, RG-188A/U, RG-161/U, RG-187A/U, RG-316/U, RG-179B/U, HAVEG 8100207, TIMES (HS-179) AA3248, TELEDYNE 11299, RAYCHEM 7528H1424	071094	M39029/76-424	077987	M39029/78-432		

Contact Size	Cable	Contact Part Number				Crimping Tools	
		Pin		Socket		Inner contact	Crimp ferrule
		Proprietary	Standard	Proprietary	Standard		
12	RG-174A/U, RG-188A/U, RG-161/U, RG-187A/U, RG-316/U, RG-179B/U, Haveg 8100207, Times (HS-179) AA3248, Teledyne 11299, Raychem 7528H1424	900340	M39029/28-211	900354	M39029/27-210	M22520/2-01 with Positioner M22520/2-34 or with Daniels Positioner K323	M22520/31-01 with Positioner M22520/31-02 or Daniels GS200 Tool with Positioner G2P330
	RG-180B/U, RG-195A/U, Raychem 9528A1318	900341	M39029/28-409	900286	M39029/27-402		
	Raychem 5022E5111	900424		900425			
	Raychem 9530A5314	900426		900427			
	Raychem 9527A1318	071954		900420			
	GORE GWN1159A	900428		900429			

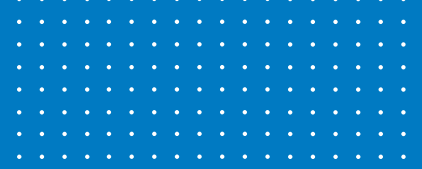

SHIELDED COAXIAL CONTACT

MIL-DTL-38999 SERIES I, III / EN3645

Coaxial Contacts

Contact Size	Cable	Contact Part Number				Crimping Tools	
		Pin		Socket		Inner contact	Crimp ferrule
		Proprietary	Standard	Proprietary	Standard		
16	RG-178B/U, RG-196A/U	070575	M39029/76-425	071965	M39029/77-429	M22520/2-01 with Positioner M22520/2-35 or with Daniels Positioner K532	M22520/4-01 with Positioner M22520/4-02
	HAVEG 30-00761, 30-02024, 30-02033 TENSOLITE 24713/A955KK1, 26723/A955KK1	900309		900310			
	HAVEG 61-02051	900186		603247			
	RG-174A/U, RG-188A/U, RG-161/U, RG-187A/U, RG-316/U, RG-179B/U, HAVEG 8100207, TIMES (HS-179) AA3248, TELEDYNE 11299, Raychem 7528H1424	071094	M39029/76-424	070248	M39029/77-428		
	KX22A	900132		900142			
	KX21A	900131		900141			

Contact Size	Cable	Contact Part Number				Crimping Tools	
		Pin		Socket		Inner contact	Crimp ferrule
		Proprietary	Standard	Proprietary	Standard		
12	RG-174A/U, RG-188A/U, RG-161/U, RG-187A/U, RG-316/U, RG-179B/U, Haveg 8100207, Times (HS-179) AA3248, Teledyne 11299, Raychem 7528H1424	900340	M39029/28-211	900350	M39029/75-416	M22520/2-01 with Positioner M22520/2-34 or with Daniels Positioner K323	M22520/31-01 with Positioner M22520/31-02 or Daniels GS-200 Tool with Positioner G2P330
	RG-180B/U, RG-195A/U, Raychem 9528A1318	900341	M39029/28-409	900351	M39029/75-417		
	Raychem 5022E5111	900424		900421			
	Raychem 9530A5314	900426		900422			
	Raychem 9527A1318	071954		900430			
	Gore GWN1159A, Nexans RG179-DT	900428		900075			

SHIELDED COAXIAL CONTACT

MIL-DTL-38999 SERIES I, III / EN3645

Contact Size	Cable	Contact Part Number				Crimping Tools	
		Pin		Socket		Inner contact	Crimp ferrule
		Proprietary	Standard	Proprietary	Standard		
8	RG-187A/U, RG-179B/U, RG-174A/U, RG-188A/U, RG-316/U, RG-161/U, Haveg 8100201, Times (HS-179)AA3248, Teledyne 11299	900135		900145		M22520/2-01 with Positioner M22520/2-31 or solder	M22520/5-01 with die set M22520/5-03 (A) or M22520/508 (B) or M
	RG-142B/U, RG-223/U, SF-142 (solder inner conductor)	900136		900146			M22520/5-01 with die set M22520/5-05 (A) or M22520/519 (B) or M22520/1001 with Die Set M22520/10-07 (A)
	Haveg 51-03111, Tensolite 28895/2X1	600900		600910		M22520/2-01 with Positioner M22520/2-31** or solder	M22520/5-01 with die set M22520/5-41 (B)
	RG-180B/U, RG-195A/U, Raychem 9528A1318	900130	M39029/60-367 Supersedes MS27536	900140	M39029/59-366		
	RD-316 Double Shield (M17/152-00001)	900137		900147		M22520/2-01 with Positioner M22520/2-31	M22520/5-01 with die set M22520/5-37 (B) or M22520/10-01 with die set M22520/10-15 (A)
	RG-400, ECS3C058A, ECS352001, ECS432101	900138		900148		M22520/2-01 with Positioner M22520/2-10	M22520/5-01 with die set M22520/5-45 (A)
	RG-58(M17/155-00001), M17/028-RG-058, RG303, Times LMR-195-UF	600901		600911		Solder	M22520/5-01 with die set M22520/5-05 (B)
	5021D1331-0	600902		600912		M22520/2-01 with Positioner M22520/2-31	M22520/5-01 with die set M22520/5-05 (B) or M22520/10-01 with die set M22520/10-07 (B)
	5M2869-001, ESC432101, BMS13-65	600903		600913			
	5022A1311-0	600904		600914			

IMPEDANCE MATCHED COAXIAL CONTACT

AMPHENOL® MATCHED IMPEDANCE SIZE 12 COAXIAL CONTACTS FOR RF/MICROWAVE, HIGH FREQUENCY AND HIGH PERFORMANCE REQUIREMENTS

Coaxial Contacts

The use of this contact is mandatory when the performance of standard Mil or EN contacts is not sufficient to achieve the level of signal transmission required. Below a large range of contacts with the correspondence of cable PN.



MATCHED IMPEDANCE COAX CONTACT PERFORMANCE

- Contact impedance = 50 ohms nominal
- Frequency range = 0–3 GHz Operable at higher frequencies depending on cable selection. Consult Amphenol for details.
- Dielectric withstanding voltage (for a mated pair):
At sea level = 1000 VRMS
At 50,000 ft. = 250 VRMS
- Insulation resistance: 5 gigaohms min. @ 25°C
- VSWR: 1.20 + .04F (F in GHz) max. up to 3 GHz
- Insertion Loss: .11 fGHz dB max.
- Environmental Specifications:
 - Thermal limits: -55 ° to 200°C
- Mechanical Specifications:
 - Mating: slide-on
 - Mounting: conforms to M39029/102 & /103 envelope dimensions

MIL-DTL-38999 SERIES I, II, III / EN3645 / EN4165

Contact Size	Cable	Contact Part Number				Crimping Tools	
		Pin		Socket		Inner contact	Crimp ferrule
		Proprietary	Standard	Proprietary	Standard		
12 (Series II)	RG-316, T-Flex-405	900384		600750		MH992 with K1360 (5)	M22520 5-01 with M225205-03(a)
	RG178, Gore CXN 340	600907		600659		MH992 with K1360 (4)	
12 (Series III)	RD316, Filotex, ET124962, M17/152-00 001	900385	M39029/103 type	900395	M39029/102 type	MH992 with K1360 (5)	
	JN1088WT	600905		600915		MH992 with K1360 (6)	
	PAN6422XQ	600906		600916		MH992 with K1360 (5)	
	RG178, GORE CXN 3403	600907		600917		MH992 with K1360 (4)	
	SFT-316-TR	600908		600918		MH992 with K1360 (5)	
	RG316	900384		900394		MH992 with K1360(5)	

MH992 is supplied by DMC Tools

SHIELDED COAXIAL CONTACT

TYPICAL COAXIAL CONTACT INSTALLATION INSTRUCTIONS

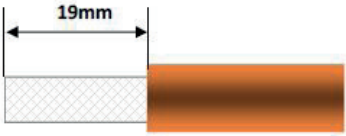
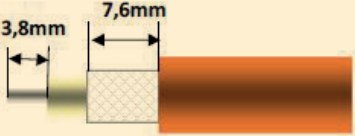
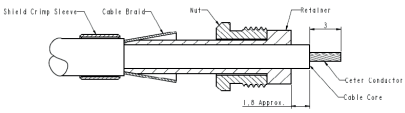
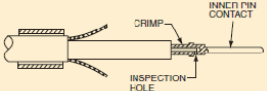
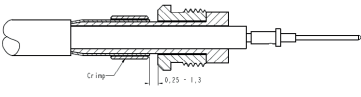
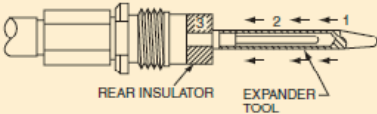
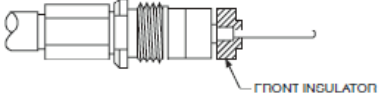
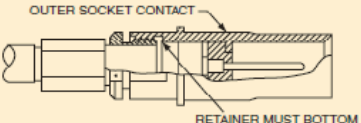
Picture	Process	Check	Tools
	Strip the jacket slide the piggy back grommet and crimping ferule	Do not damage the braid	Blade
	Trim shield strip cable core	Do not damage the inner conductor	Blade
	Position nut on retainer as illustrated flare shield and slide nut and retainer assembly under the cable shield until retainer bottoms against braid		
	Slide inner pin contact over cable center conductor crimp inner conductor	The inner conductor shall be visible thru the inspection hole	M22520/2-01 with positioner M22520/2-31 (5)
	Slide nut and retainer assembly forward until retainer flush with edge of cable core crimp shield crimp sleeve and observe a 0,25 and 1,3mm dimension	Nut must be rotate freely after crimping sleeve	M22520/5-01 with die M22520/5-37 (B)
	Slide rear insulator using expander tool. slide tool over inner pin contact. Push rear insulator with push rod until it seats between retainer end and inner pin contact shoulder		Expander tool bendix p/n 11-10136 or equivalent rod bendix p/n 11-10135 or equivalent
	Snap rear insulator behind inner contact shoulder slide front insulator until the inner contact flange		
	Slide outer socket contact over inner pin assembly and insulator thread nut into rear of outer pin contact tighten nut until metal to metal (0,21 - 0,25N.m)	Do not allow the cable to rotate while tightening the nut	

SHIELDED COAXIAL CONTACT

MIL-DTL-38999 SERIES I, III / EN3645



PRINT CIRCUIT BOARD CONTACTS

Contact Size	Tail Length	Contact Part Number		Gold	Tin
		Pin	Socket		
		Proprietary	Proprietary		
16	CI	900184	900405	X	
	CI	900179	600748		X

Contact Size	Tail Length	Contact Part Number		Gold	Tin
		Pin	Socket		
		Proprietary	Proprietary		
12	CI	900489	600749	X	
	LI	900409	900412	X	

IMPEDANCE MATCHED PCB COAXIAL CONTACT 900461 - SIZE 12

MATCHED IMPEDANCE COAX CONTACT PERFORMANCE :

- Contact impedance = 50 ohms nominal
 - Frequency range = 0–3 GHz Operable at higher frequencies depending on cable selection. Consult Amphenol for details.
 - Dielectric withstanding voltage (for a mated pair):
At sea level = 1000 VRMS
At 50,000 ft. = 250 VRMS
 - Insulation resistance: 5 gigaohms min. @ 25°C
 - VSWR: 1.20 + .04F (F in GHz) max. up to 3 GHz
 - Insertion Loss: .11 fGHz dB max.
- Environmental Specifications:
- Thermal limits: –55°C to 200°C



SHIELDED COAXIAL CONTACT

Pin 900184, Socket 900405

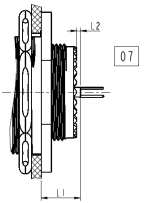
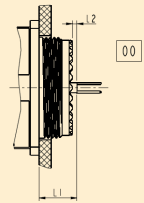
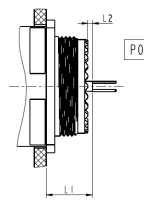
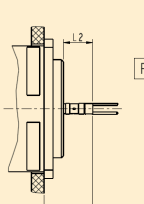
Connectors with Coax Contacts		MIL-DTL-38999 series I		MIL-DTL-38999 series III / EN3645				MIL-DTL-38999 series III / EN3645 composite		
	Sizes	9 to 17	19 to 25	9 to 11	13	15 to 17	19 to 25	9 to 11	13 to 25	
	Pin	L1	8,3 - 9,5		9,7 - 10,9		9,6 - 10,8		9,7 - 10,9	9,6 - 10,7
		L2	0,7 - 1,9	0,3 - 1,5	0,6 - 1,8		0,6 - 1,7	0,6 - 1,8	(-0,5) - 0,7	
	Socket	L1	7,9 - 9,1		9,3 - 10,5		9,2 - 10,4		9,3 - 10,5	9,2 - 10,3
		L2	0,3 - 1,5	(-0,1) - 1,1	0,2 - 1,4		0,2 - 1,3	0,2 - 1,4	(-0,9) - 0,3	
	Sizes	9 to 25		9 to 25				9 to 19	21 to 25	
	Pin	L1	13,4 - 14,5		8,9 - 10				8,9 - 10,1	9 - 10,1
		L2	1,2 - 2,5		0,6 - 1,8				0,6 - 1,8	
	Socket	L1	13 - 14,1		8,5 - 9,6				8,5 - 9,7	8,6 - 9,7
		L2	0,8 - 2,1		0,2 - 1,4				0,2 - 1,4	
	Sizes	9 to 19	21 to 25	9 to 19		21 to 25		9 to 19	21 to 25	
	Pin	L1	10,9 - 12	11,7 - 12,8	11,2 - 12,3		11,9 - 13		12,4 - 13,4	13,2 - 14,2
		L2	0,9 - 2,1		0,6 - 1,8				0,6 - 1,8	
	Socket	L1	10,5 - 11,6	11,3 - 12,4	10,8 - 11,9		11,5 - 12,6		12 - 13	12,8 - 13,8
		L2	0,5 - 1,7		0,2 - 1,4				0,2 - 1,4	
	Sizes	/		9 to 19		21 to 25		/		
	Pin			L1	11,2 - 12,3		11,9 - 13			
				L2	6,4 - 7,7					
	Socket			L1	10,8 - 11,9		11,5 - 12,6			
				L2	6 - 7,3					

RF COAXIAL CONTACT

MIL-DTL-38999 SERIES I, III / EN3645

FEATURES AND BENEFITS

- The HIGHEST frequency available on the market : up to 65 GHz
- The LARGEST range of size available on the market : 3 sizes - 8, 12 & 16
- Designed for HARSH ENVIRONMENT : resistance to shocks and vibrations
- Unique float mount technology to allow constant microwave performance



APPLICATIONS

- Battlefield communications : high frequency applications
- Aerospace
- Telecom : radars, wireless networks (wifi, GSM)

MATERIALS AND FINISH

Body and Sleeve :

Stainless steel per AMS-5640 Alloy UNS S30300 Type 1

Ferrule :

Brass per ASTM B16, Alloy UNS C36000

Contact & Lock Ring :

Beryllium copper per ASTM B196 Alloy UNS C17300, Td04

Insulator :

PTFE per ASTM D1710, Type 1, Grade 1, Class B

Spring :

Stainless steel per ASTM A313 Type 631

Rear Body & Contacts :

Gold per ASTM B488 Type II, Code C, Class 1.27;
 over Nickel per AMS-QQ-N-290 Class 1 (60µ inches);
 over Copper per MIL-C-14550 (10µ inches)
 Passivated per AMS-2700, Type 2

RF COAXIAL CONTACT

MIL-DTL-38999 SERIES I, III / EN3645



Contacts size 8 BMZ Interface

BMZ INTERFACE SPECIFICATIONS

Impedance	50 Ω
Frequency Range	DC – 40 GHz
VSWR	1.07+.01 (freq. GHz)
Insertion Loss	0.06√ (freq. GHz)
Contact Resistance (Max.)	
center conductor:	6.0 mΩ
outer conductor:	3.0 mΩ
outer to cable:	0.5 mΩ
Insulation Resistance (Min.)	10,000MΩ
DWV	1,000 VRMS
RF Leakage	-(80-freq. GHz)
Corona Extinction Voltage	250 VRMS
RF High Potential Voltage	500 VRMS



Contacts size 8 BMA Interface

BMA INTERFACE SPECIFICATIONS

Impedance	50 Ω
Frequency Range	DC – 26,5 GHz
VSWR	
DC to 18 GHz	1.05 + .005f (GHz)
18 to 22 GHz	1.05 + .009f (GHz)
Insertion Loss	0.3x√f (freq. GHz)
Contact Resistance (Max.)	
center conductor:	2.0 mΩ
outer conductor:	2.0 mΩ
Insulation Resistance (Min.)	5,000MΩ
DWV	1,000 VRMS
RF Leakage	-(90-fGHz)
Corona Extinction Voltage	670 VRMS
RF High Potential Voltage	500 VRMS

RF COAXIAL CONTACT

MIL-DTL-38999 SERIES I, III / EN3645

SMPM INTERFACE SPECIFICATIONS

Impedance	50 Ω
Frequency Range	DC – 65 GHz
VSWR	1.1:1 DC to 26.5 GHz (typical) 1.3:1 26.5 to 65 GHz (typical)
Insertion Loss (Adapters)	.10 dB x √f (where f = GHz) dB
Insertion Loss (Cable Connectors)	.12 dB x √f (where f = GHz) dB
Contact Resistance (Max.)	
center conductor:	6.0 mΩ
outer conductor:	2.0 mΩ
Insulation Resistance (Min.)	5,000MΩ
DWV	325 VRMS
RF Leakage	–80 dB from DC to 3 GHz –65 dB from 3 to 65 GHz



Contact Size	Interface	Cable	Frequency	Contact Part Number		Piggyback Grommet
				Pin	Socket	
8	BMZ	TFLEX-405	40 GHZ	600920	600925	
		TFLEX-405	18 GHZ	600921	600926	
		RG-400/ RG-142	12 GHZ	600922	600927	900471
		TFLEX-402	18 GHZ	600923	600919	900472
	BMA	TFLEX-405	26.5 GHZ	600600	600580	
		TFLEX-402	26.5 GHZ	600606	600581	900472

Contact Size	Interface	Cable	Frequency	Contact Part Number		Piggyback Grommet
				Pin	Socket	
12	SMPM	TFLEX-405	65 GHZ	600924	600928	

Contact Size	Interface	Cable	Frequency	Contact Part Number		Piggyback Grommet
				Pin	Socket	
16	SMPM	0.047 DIA CABLE	65 GHZ	600929	600930	

75 OHMS COAXIAL CONTACT

MIL-DTL-38999 SERIES I, III / EN3645



FEATURES AND BENEFITS

- MIL-DTL-38999 / EN3645 CONNECTORS
- CRIMP AND PCB VERSION AVAILABLE
- MEET 3G-SDI VIDEO FORMAT

MATERIALS AND FINISH

Sleeve : Stainless steel
 Contact & Ferrule : Copper Alloy
 Insulator: PTFE
 Rear Body & Contacts: Gold over nickel

SMPTE STANDARDS

SMPTE: Society of Motion and Television Engineers
 SDI: Serial Digital Interface
 SD-SDI: Standard Definition SDI (SMPTE 259M)
 ED-SDI: Enhanced Definition SDI (SMPTE 344M)
 HD-SDI: High Definition SDI (SMPTE 292M)
 3G-SDI: (SMPTE 424M)

75 OHMS SIZE 6 CONTACTS AND CONNECTORS

Contact Size	Cable	SMPTE			Contact Part Number		Piggy Back Grommet
		SD-SDI	HD-SDI	3G-SDI	PIN	SOCKET	
6	RG179B/U	X	X	X	600757	603180	600762
	DRAKA HD PRO 0.8/3.7 AF	X	X	X	600813	600715	600759
	BELDEN RG59 0.8/3.7	X	X	X			
	GRÜN 0.6/3.7	X	X	X			

SIZE 6 CONTACT CONNECTORS AND ARRANGEMENTS



SHELL SIZE: 11
Please consult us

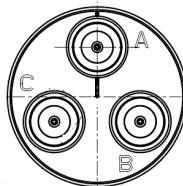

SHELL SIZE: 19
Please consult us

75 OHMS COAXIAL CONTACT

MIL-DTL-38999 SERIES I, III / EN3645

75 OHMS SIZE 8 PERFORMANCE

IMPEDANCE: 75Ohms
 FREQUENCY RANGE: 0 – 3GHz . Meet 3G-SDI standard (SMPTE 424M)
 Insulation resistance: 5GΩ min @ 25°C
 Dielectric Withstanding Voltage:
 1300Vrms Rms @ sea level
 250 VRms @ 50 000ft



Contact Size	Cable	SMPTE			Contact Part Number		Piggy Back Grommet
		SD-SDI	HD-SDI	3G-SDI	PIN	SOCKET	
8	RG179B/U	X	X	X	600822	600841	603161
	PIC V75268	X	X	X	600830	600836	900472
	PIC V76261	X	X	X			
	PIC 73263	X	X	X			
	EMTEQ TFLX125-075-01	X	X	X			

75 OHMS SIZE 8 PRINT CIRCUIT BOARD CONTACTS

Contact Size	Tail Length	SMPTE			Contact Part Number	
		SD-SDI	HD-SDI	3G-SDI	PIN	SOCKET
8	Cl	X	X	X	600889	600909

NOTES

A series of horizontal dotted lines for taking notes.



TWINAX CONTACTS

Amphenol Twinax contacts were designed for use with twinax cable in data Bus systems.

FEATURES AND BENEFITS

- Protection from magnetic interference
- Protection from electrostatic interference including nuclear electromagnetic pulse
- Meets parameters defined by MIL-STD-1553B
- Maintains shield integrity through a multi-pin circular connector and does not require contact polarization within the insert

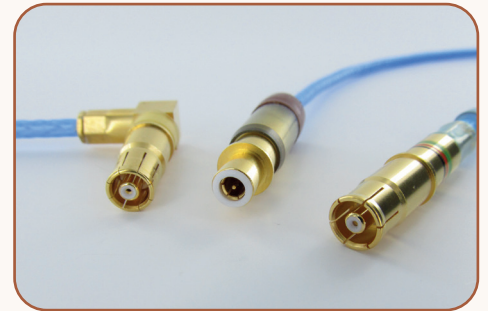

MATERIALS AND FINISH

- Body: Copper alloy
- Finish: Gold over nickel on mating parts
- Insulators: High Performance Fluorocarbon or PEEK

TYPICAL TWINAXIAL CABLE

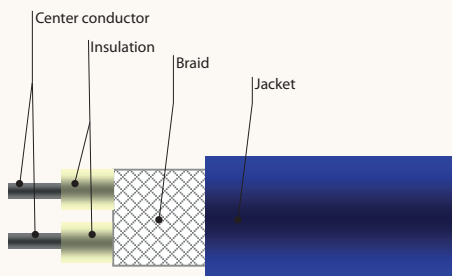

? DO YOU KNOW BUS1553 AND ARINC429 ?

- **Amphenol size 8 concentric twinax** are designed for use in MIL-STD-1553 data bus. MIL-STD-1553 is a military standard published by the United Department of Defense that defines the mechanical, electrical and functional characteristics of a serial data bus.
- **Amphenol size 8 concentric twinax** are designed for use in ARINC429 or DITS (Data Information Transfer System). ARINC429 is technical standard for the avionics data bus used commercial and transport aircraft.

TWINAX CONTACTS

MIL-DTL-38999 SERIES I, III / EN3645

INTERFACE AND QUALIFICATION : SAE AS39029 / 90/91/113/114



Concentric Twinax Contacts

FEATURES AND BENEFITS

- 175°C rated and meets performance levels of MIL-DTL-38999 series III connectors
- MIL-C-17/176-00002 cable termination
- Gold plated full crimp termination contacts qualified to M39029/90 & 91

TYPICAL ELECTRICAL PERFORMANCE:

Voltage Rating: 500 Vrms max. @ sea level

Contact Resistance:

Center @ 1 Amp: 55 millivolts max. voltage drop @ 25°C
 Intermediate @ 1 Amp: 55 millivolts max. voltage drop @ 25°C
 Outer @ 12 Amps: 75 millivolts max. voltage drop @ 25°C

Operating Frequency: 0–20 MHz

Dielectric Withstanding Voltage:

Center to Intermediate: 1000 VAC Rms @ Sea Level
 Intermediate to Outer: 500 VAC Rms @ Sea Level

Contact Size	Cable	Contacts Part Number				Comments
		PIN		SOCKET		
		Proprietary	Standard	Proprietary	Standard	
8	M17/176-00002	074834	M39029/90-529	072453	M39029/91-530	Supplied with heat shrink seal
	M17/176-00002	600850	M39029/113-625	600851	M39029/114-628	Supplied with heat shrink seal

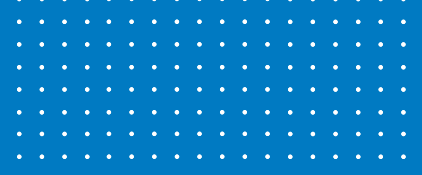

TWINAX CONTACTS

MIL-DTL-38999 SERIES I, III / EN3645 / EN4165 INTERFACE AND QUALIFICATION : EN3155-024 -025 & ABS2217

Concentric Twinax Contacts

EN3155
QUALIFIED

ABS2217
COMPLIANT

FEATURES AND BENEFITS

- 200°C rated and meets performance levels of MIL-DTL-38999 series III connectors, EN3645 and EN4165
- Many EN3375 cable termination
- Gold plated full crimp termination contacts qualified to EN3155-024 -025



TYPICAL ELECTRICAL PERFORMANCE

Voltage Rating: 500 Vrms max. @ sea level

Contact Resistance:

- Center @ 1 Amp: 55 millivolts max. voltage drop @ 25°C
- Intermediate @ 1 Amp: 55 millivolts max. voltage drop @ 25°C
- Outer @ 12 Amps: 75 millivolts max. voltage drop @ 25°C

Dielectric Withstanding Voltage:

- Center to Intermediate: 1000 VAC Rms @ Sea Level
- Intermediate to Outer: 500 VAC Rms @ Sea Level

Contact Size	Cable	Contact Part Number				Crimping Tools	
		Pin		Socket		Inner contact	Intermediate Outer
		Proprietary	Standard	Proprietary	Standard		
8	EN3375-003 KG24	600611	EN3155-024M08AA	600614	EN3155-025F08AA	M22520/2-01 with Daniels positionner K880	M22520/5-01 with Daniels tools Y832
	EN3375-004 WJ24	600612	EN3155-024M08BA	600615	EN3155-025F08BA		
	EN3375-005 WV24	600613	EN3155-024M08CA	600616	EN3155-025F08CA		
	EN3375-009 W26	600854	ABS2217P01	600855	ABS2217S01	M22520/2-01 with Daniels positionner K1815	M22520/5-01 with Daniels tools Y832
	EN3375-006 XM24	600856	ABS2217P02	600857	ABS2217S02		
	EN3375-004 WJ24	600858	ABS2217P03	600859	ABS2217S03		

TWINAX CONTACTS

1760 INTERFACE

Concentric Twinax Contacts

Contact Size	Cable	Contact Part Number				Crimping Tools	
		Pin		Socket		Inner contact	Intermediate Outer
		Proprietary	Standard	Proprietary	Standard		
8	Raychem 10614 EPD44692 EPD44695	076590	711-1760-101	076589	711-1760-201	M22520/2-01 with Daniels positionner K880	M22520/5-01 with Daniels tools Y832
	PAN6421 Raychem 10613	076915	711-1760-102	076588	711-1760-202		
	Raychem 10612 M17/176-00002 EPD44690 EPD44691	077517	711-1760-104	077516	711-1760-204		



Delivered without heat shrink boot or piggy back grommet

TWINAX CONTACTS FOR ARINC600

ABS1600 AND ABS1607



TYPICAL ELECTRICAL PERFORMANCE

Voltage Rating: 500 Vrms max. @ sea level

Contact Resistance:

Center @ 1 Amp:

55 millivolts max. voltage drop @ 25°C

Intermediate @ 1 Amp:

55 millivolts max. voltage drop @ 25°C

Outer @ 12 Amps:

75 millivolts max. voltage drop @ 25°C

Operating Frequency:

0–20 MHz

Dielectric Withstanding Voltage:

Center to Intermediate:

1000 VAC Rms @ Sea Level

Intermediate to Outer:

500 VAC Rms @ Sea Level

Contact Size	Cable	Contact Part Number			
		Pin		Socket	
		Proprietary	Standard	Proprietary	Standard
8	EN3375-004	140675	ABS1600M08A	140683	ABS1607F08A

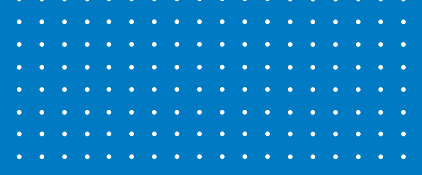

TYPICAL CONTACTS INSTALLATION INSTRUCTIONS FOR TWINAX CONTACTS

PICTURE	PROCESS	CHECK	TOOLS
	<p>Strip the jacket</p> <p>Slide the piggy back grommet and crimping ferule</p>	<p>Do not damage the braid</p>	<p>Blade</p>
	<p>Open the braid over the crimping ferule</p>	<p>The braid shall cover equally the crimping ferule</p>	
	<p>Strip the inner conductors</p>	<p>Do not damage the inner conductors</p>	<p>Blade</p>
	<p>Insert the white jacket inner conductor into the inner contact and crimp</p>	<p>The inner conductor shall be visible thru the inspection hole</p>	<p>M22520/2-01 with positionner</p>
	<p>Insert the crimp inner contact into the center hole and insert the blue inner conductor in the intermediate contact crimp the intermediate contact</p>	<p>The inner conductor shall be visible thru the inspection hole</p>	<p>M22520/5-01 with correct die</p>
	<p>Push the sub assembly into the outer contact when nice installed, cut the additional braid</p>	<p>Do not damage the crimping ferule</p>	<p>Blade</p>
	<p>Crimp the outer contact</p>		<p>M22520/5-01 with correct die</p>

TWINAX CONTACTS

MIL-DTL-38999 SERIES III / EN3645

PRINT CIRCUIT BOARD CONTACTS AND SPECIFICS

Pin 072265, Socket 600709



Connectors with Twinax Contacts		MIL-DTL-38999 series III				MIL-DTL-38999 series III / EN3645 composite	
	Sizes	9 to 11	13	15 to 17	19 to 25	9 to 11	13 to 25
	Pin/Socket	L1	10,4 - 11,6		10,2 - 11,4		10,4 - 11,6
	L2	1,2 - 2,5		1,2 - 2,3	1,2 - 2,5	0,1 - 1,4	
	Sizes	9 to 25				9 to 19	21 to 25
	Pin/Socket	L1	9,5 - 10,6				9,5 - 10,7
	L2	1,2 - 2,5				1,2 - 2,5	
	Sizes	9 to 19		21 to 25		9 to 19	21 to 25
	Pin/Socket	L1	11,8 - 12,9		12,5 - 13,7		13 - 14,1
	L2	1,2 - 2,5				1,2 - 2,5	



INFORMATION

AMPHENOL CAN ALSO PROVIDE SPECIFIC AND CUSTOM TWINAX CONTACT SUCH AS:

- SIZE 10 and 12
- SIZE 8 HOODED
- 90° TWINAX

PLEASE CONSULT US

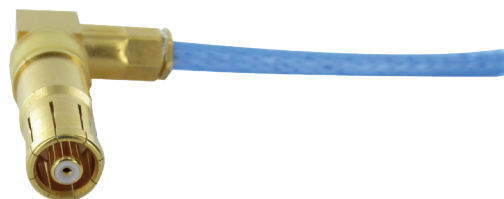



DIFFERENTIAL TWINAX CONTACTS

Differential Twinax Contacts

MIL-DTL-38999 SERIES III / EN3645 / EN4165

FEATURES AND BENEFITS

- Offer several advantages for high data transfer rates, low power consumption and excellent EMI compatibility:
- Two strategically spaced inner contacts form two 100 or 150 Ohm matched impedance differential pairs
- Outer contact has rugged wall section for durability
- Available in size 8 crimp termination style
- Also available in size 8 with PC tails
- Requires modification of MIL-DTL-38999 connector to accommodate keyed contacts



MATERIALS AND FINISH

- Body: Copper alloy
- Finish: Gold over nickel on mating parts
- Insulators: High Performance Fluorocarbon or PEEK



TYPICAL TWINAXIAL CABLE

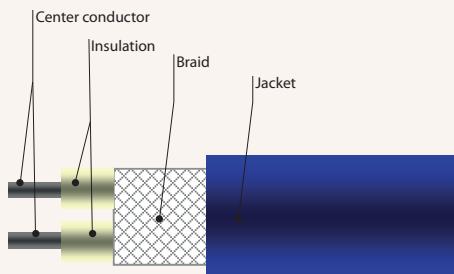

TYPICAL ELECTRICAL PERFORMANCE

- Bandwidth: Up to 1.25 GHz
- Data Rate: Exceeding 2.5 Gbps
- Voltage Rating: 500 Vrms max. @ sea level
- Dielectric Withstanding Voltage: 1000 VAC rms between all inner contacts @ sea level 500 VAC rms between inner and outer contacts @ sea level

DIFFERENTIAL TWINAX CONTACTS

MIL-DTL-38999 SERIES III / EN3645 / EN4165

CRIMP CONTACTS

Cable	Contact Part Number			Crimping Tools	
	Pin	Socket	Impedance (Ohms)	Inner contact	Outer contact
Tensolite 24463/05099X-8(LD), Thermax MX 100-24, Tensolite 24463/9P025X-2(LD), Thermax 12814, ST5M1284-003 (98 Ohm), 26463/70460X- 2 (98 Ohm), PIC E10224, Fileca 2709-3, NF24T100-200C (Space), S280W502-1	900418	900419	100	M22520/2-01 with M22520/2-37 or with Daniels positionner K709	M22520/5-01 with die set M22520/5-45 (Location A)
GORE GSC-05-827300-00 Tensolite 26453/03184X-2(LD) Thermax 956-626Z	600931	600932			
Tensolite 26453/03184X-2(LD), Thermax 956-626Z, GORE GSC-05-827300-00 ASNE08072003-09	600933	600934			
23460/05114X-2(LD), PIC E1024	600935	600936			
Raychem 0026A0024, M17/176-00002 (77 Ohm)	600937	600938			
JSFY11-24, Tensolite 24463/03220T-2(LD), Thermax 956-1T200	600939	600940			
S280W502-6, Tensolite 24463/9P026X-2(LD)	600941	600942			
AXON P509782	600943	600944			
Tensolite 26453/03184X-2(LD)	600945	600946			
Gore DXN 2125	600947	600948			
Tensolite 26483/03071X-2(LD)	900294	900299	150		
Tensolite 26483/03071X-2(LD)	600858	600899			

QUADRAX CONTACTS

MIL-DTL-38999 SERIES III / EN3645 / EN4165

FEATURES AND BENEFITS

Amphenol® Quadrax Contacts - Offer several advantages for high data transfer rates, low power consumption and excellent EMI compatibility:

- Four strategically spaced inner contacts form two 100 or 150 Ohm matched impedance differential pairs
- Outer contact has rugged wall section for durability
- Available in size 8 crimp termination style
- Also available in size 8 with PC tails
- Requires modification of MIL-DTL-38999 connector to accommodate keyed contacts

MATERIALS AND FINISH

- Body: Copper alloy
- Finish: Gold over nickel on mating parts
- Insulators: High Performance Fluorocarbon or equivalent

TYPICAL QUADRAX CABLE

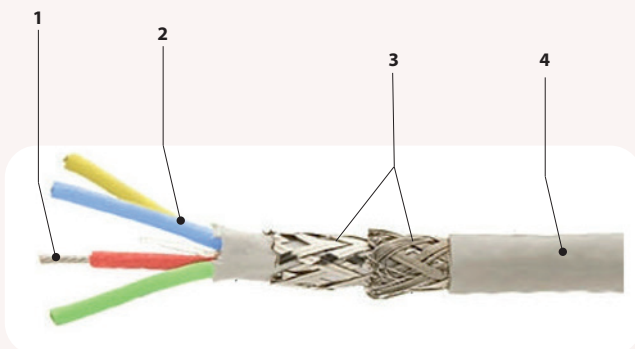

- 1 – 4 Center conductor
- 2 – 4 Insulation
- 3 – Braid
- 4 – Jacket

TYPICAL QUADRAX CABLE

- Bandwidth: Up to 1.25 GHz
- Data Rate: Exceeding 2.5 Gbps.
- Voltage Rating: 500 Vrms max. @ sea level
- Dielectric Withstanding Voltage:
 - 1000 VAC rms between all inner contacts @ sea level
 - 500 VAC rms between inner and outer contacts @ sea level

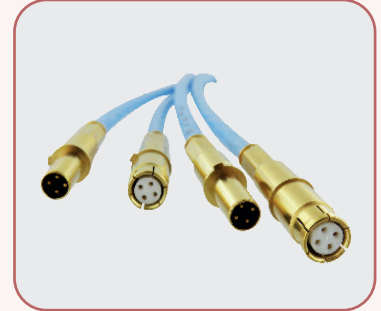
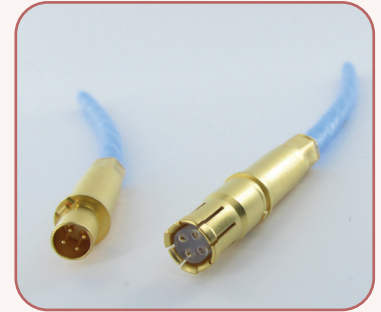

QUADRAX CONTACTS

TV SERIES, MIL-DTL-38999 SERIES III / EN3645 / EN4165

CRIMP CONTACTS

Contact Size	Cable	Contact Part Number			Inner conductor Gauge	Electrical Protocol	Crimping Tools				
		Pin	Socket	Impedance (Ohms)			Inner contact	Outer contact			
8	Draka Fileca F-4703-3, F4704-4, Filotex ET 2PC236, Filotex ET2PF870, PIC Wire E50424, ABS0972, Tensolite 23450/04090X-4(LD) Draka Fileca F-4704-5, ABS1503 KD 24	900496	900361	100	24	Ethernet, 1000 Base-T Gigabit Ethernet	M22520/2-01 with Positioner M22520/2-37 or with Daniels Positioner K709	M22520/5-01 with Die Set M22520/5-45 (Location A)			
	Tensolite NF24Q100, NF24Q100-01, 24443/9P025X-4(LD), S280W502-4, 24443/03130X-4(LD), 24443/C20714X-4(LD), 24450/0120X-4(LD), NF24-2Q100, TYCO CECRWC-18664, GORE GSC-01-81869-01, 24443/03166X-4(LD), Thermax T956-4T200, Pic Wire E51424, Thermax MX100Q-24, NF24Q100-01-200C (Space), BMS13-72T03C04G024	900330	900338								
	Tensolite NF22Q100, NF22Q100-01, Thermax 956-5, GORE RCN 7688	900410	900411								
	Tensolite NF26Q100, NF26Q100-01, NF26-2Q100, PIC E51426, Wirenetics W-3714-379	600514	600516								
	S280W502-4/BMS13-72T03C04G024	600953	600954								
	Draka Fileca F-4704-6, Gore RCN 8672	600513	600515								
	Gore RCN8513, JSFY18-3										
	Tensolite NF24Q100, NF24Q100-01 for 2.5 Gbps applications	600951	600952								
	Gore 8647	600955	600956								
	USB2 (28433/02171LX-4)	600957	600958						90		USB2.0 (480 Mbps)
	Tensolite 24450/03089X-4(LD) Gore RCN8647	050998	050999						110	24	IEEE 1394B Firewire
	JSFY02-1, JSFY18	600959	600960								IEEE 1394B Firewire
	Gore RCN8487, JSFY18	600961	600962								IEEE 1394B Firewire
	Tensolite 26473/02006X-4(LD)/Gore RCN8328 (not for new designs, use 21-033450/1 series)	900327	900337						150	26	

EN3155-074 AND -075 CRIMP CONTACTS

EN3155 QUALIFIED

Contact Size	Cable	Contact Part Number				Impedance (Ohms)	Inner conductor Gauge	Electrical Protocol	Crimping Tools	
		Pin		Socket					Inner contact	Outer contact
		Proprietary	Standard	Proprietary	Standard					
8	ABS1503KD24	600963	EN3155-074M8A	600964	EN3155-075F08A	100	24	Ethernet, 1000 Base-T Gigabit Ethernet	M22520/2-01 with Positioner M22520/2-37 or with Daniels Positioner K709	M22520/5-01 with Die Set M22520/5-45 (Location B)
		603085	EN3155-074M08	603086	EN3155-075F08					

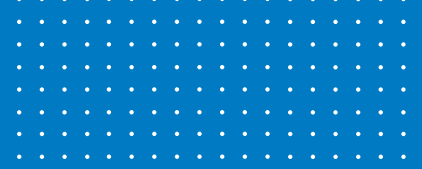

QUADRAX CONTACTS FOR SUBMINIATURE

TYPICAL CONTACTS INSTALLATION INSTRUCTIONS FOR QUADRAX CONTACTS

Picture	Process	Check	Tools
	<p>Strip the jacket</p> <p>Slide the piggy back grommet and crimping ferule</p>	<p>Do not damage the braid</p>	<p>Blade</p>
	<p>Open the braid over the crimping ferule</p>	<p>The braid shall cover equally the crimping ferule</p>	<p>Blade (To Trim Excess Braid)</p>
	<p>Strip the inner conductors</p>	<p>Do not damage the inner conductors</p>	<p>Blade</p>
	<p>Crimp the inner contacts</p>	<p>The inner conductor shall be visible thru the inspection hole</p>	<p>M22520/2-01 with positionner M22520/2-37</p>
	<p>Install the rear insulator and respect the circular location for each individual contact</p>	<p>The contact location shall respect circular location</p>	
	<p>Slide the front insulator over the contact by the front</p>	<p>The keyway orientation shall meet the key way in outer contact</p>	
	<p>Crimp the outer contact</p>		<p>M22520/5-01 with M22520/5-45(A)</p>

QUADRAX CONTACTS FOR SUBMINIATURE

MIL-DTL-38999 SERIES III / EN3645

PRINT CIRCUIT BOARD CONTACTS

Contact Size	Release	Type	Contact Part Number		Impedance (Ohms)
			PIN	SOCKET	
8	Rear	CI	900210	600520	100
	Rear	LI	600512	600519	

Quadrax Contacts

Pin 900210, Socket 600520

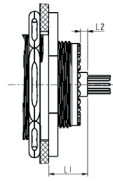
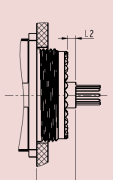
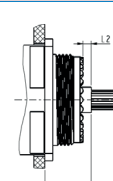
Connectors with Quadrax Contacts		MIL-DTL-38999 series III / EN3645				MIL-DTL-38999 series III / EN3645 composite		
 07	Sizes	9 to 11	13	15 to 17	19 to 25	9 to 11	13 to 25	
	Pin/Socket	L1	10,4 - 11,6	10,2 - 11,4			10,4 - 11,6	10,2 - 11,4
		L2	1,2 - 2,5		1,2 - 2,3	1,2 - 2,5	0,1 - 1,4	
 00	Sizes	9 to 25				9 to 19	21 to 25	
	Pin/Socket	L1	9,5 - 10,6				9,5 - 10,7	9,6 - 10,8
		L2	1,2 - 2,5				1,2 - 2,5	
 P00	Sizes	9 to 19		21 to 25		9 to 19	21 to 25	
	Pin/Socket	L1	11,8 - 12,9		12,5 - 13,7		13 - 14,1	13,8 - 14,9
		L2	1,2 - 2,5			1,2 - 2,5		

QUADRAX CONTACTS

ARINC600, EN3545

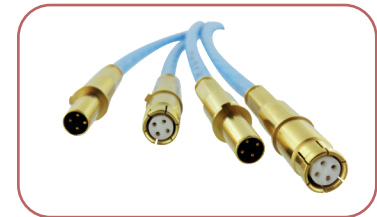

CRIMP CONTACTS

Contact Size	Cable	Contact Part Number		Impedance (Ohms)	Inner conductor Gauge	Electrical Protocol	Crimping Tools	
		Pin	Socket				Inner contact	Outer contact
8	ABS0972 ABS1503KD24	603113	603116	100	24	Ethernet, 1000 Base-T, Gigabit Ethernet, ARINC664	M22520/2-01 with positionner K709	M22520/5-01 with Die set M22520/5- 45 (Location A)
	Tensolite NF24Q100, NF24Q100-01, 24443/9P025X-4(LD), S280W502-4, 24443/03130X-4(LD), 24443/0120X-4(LD), NF24-2Q100, TYCO CECRWC-18664, GORE GSC-01-81869-01, 24443/03166X-4(LD), Thermax T956-4T200, Pic Wire E51424, Thermax MX100Q-24, NF24Q100 01-200C (Space), BMS13 72T03C04G024	603210	603209					M22520/5-01 with Die set M22520/5- 45 (Location B)

PRINT CIRCUIT BOARD CONTACTS

Contact Size	Release	Contact Part Number		Impedance (Ohms)	Connector	
		Pin	Socket		ARINC600	EN3545
8	Front	603228		100	√	
	Rear	603177	603229			

? DO YOU KNOW AFDX AND ARINC664 ?

Amphenol size 8 quadrax contacts are designed for use in ARINC664p7 or AFDX network. AFDX (Avionics Full Duplex Switched Ethernet) and ARINC 664 are a data network based on ethernet technology. AFDX is patented by AIRBUS.

NOTES

Horizontal dotted lines for notes.



SPLIT PAIR QUADRAX CONTACTS

MIL-DTL-38999 SERIES III / EN3645 / EN4165

FEATURES AND BENEFITS

- Overall higher bandwidth than standard CAT5E quadrax
- Enhanced crosstalk performance (compared to standard quadrax) due to compatibility with shielded twisted pair of cables
- Can be used for a variety of high speed applications beyond current quadrax design**
- Four strategically spaced inner contacts form two 100 Ohm matched impedance differential pairs
- Outer contact has rugged wall section for durability
- Available in size 8 crimp termination style
- Also available in size 8 PC tails
- Can be installed into existing quadrax contact connector cavities
- Requires modification of MIL-DTL-38999 connector to accommodate keyed contacts

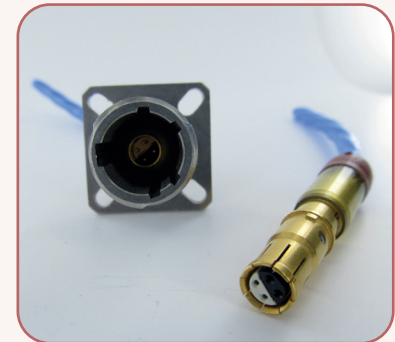

APPLICATION

For use with, but not limited to, the following electrical protocols :

- 10/100/1000/10GBASE-T Ethernet
- DVI
- USB 2.0, 3.0
- Serial Rapid IO (up to 3.125 Gbps)
- PCI-Express 2.0
- HDMI 1.3a
- SATA 2.0 (up to 3 GHz)

Suggested Numbering for Quadrax Contacts

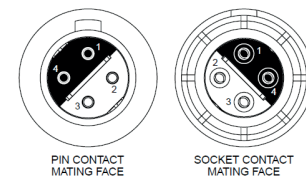

Differential Pairs: 1 & 4, 2 & 3

CRIMP CONTACTS

Contact Size	Cable	Contact Part Number		Inner conductor Gauge	Crimping Tools	
		Pin	Socket		Inner contact	Outer contact
8	Thermax 1536-224	050742	050741	24	DANIELS M22520/2-01 with positioner K1777	DANIELS M22520/5-01 with die set Y1999 or M22520/5-45

PRINT CIRCUIT BOARD CONTACTS

Contact Size	Release	Type	Contact Part Number		Impedance (Ohms)
			Pin	Socket	
8	Rear	CI	603250	600742	100
	Rear	LI	603251	603252	

** For stick out, please refer to p45

µCOM-10GB +

HARSH ENVIRONMENT 10GB ETHERNET MICRO CONNECTORS

µCom Series is a new range of connectors designed to address the latest trends of the industry : miniaturization and high speed, with the highest resistance for use in the harshest environments. µCom-10Gb + is the first product of this new range.



MAIN FEATURES

- 10Gb+ exceeds 10Gb/s Ethernet following IEEE 802.3an-2006 : 10GBase-T
- Cat.6A connector according to TIA568C.2 and ISO/IEC11801 norms
- Environmental testing based on MIL-DTL-38999 series III military specifications
- Miniature : 15 mm(.59") max external diameter

FEATURES AND BENEFITS

- 4 pairs totally insulated throughout the connector minimum cross-talk between the four pairs
- Patent pending special interfacial shapes minimum perturbation at the interface of each pair
- Thread coupling mechanism 2000 mating cycles & high vibration resistance
- Machined Brass shells and RoHS compliant plating shell to shell continuity and 500h salt Spray resistance
- Machined & gold plated Solder and Crimp contacts design & performance according to the innercontact of M39029/77-429#16 M39029/76-425#16 38999 contact
- Solder contact : max AWG24
- Crimp contact : AWG 24 to 26
- IP68 sealing mated and unmated for receptacles
- 1500 Vrms Dielectric Withstanding voltage
- Temperature range : - 55°C / + 125°C

HOW TO ORDER

Female In-line receptacles	UCOM - 10G+	L	S	B	G	A
Shell L: in line receptacle (push pull or thread)						
Contacts termination C: crimp S: solder						
Shell plating B: black nickel G: olive drab cadmium U: unplated brass						
Backshell type G: gland B: band						
Cable diameter (for gland backshell only) A: for cable diam 7.5mm B: to be defined						

Female receptacles	UCOM - 10G+	R	P	B
Shell R: receptacle (push pull or thread)				
Contacts termination P: PCB S: solder C: crimp				
Shell plating B: black nickel G: olive drab cadmium U: unplated brass				

Male plugs	UCOM - 10G+	P	T	C	B	G	A
Shell P: plug							
Mating (for plugs only) T: thread P: push-pull							
Contacts termination C: crimp S: solder							
Shell plating B: black nickel G: olive drab cadmium U: unplated brass							
Backshell type G: gland B: band							
Cable diameter (for gland backshell only) A: for cable diam 7.5mm B: to be defined							

Cordsets	UCOM - 10G+	C	T	C	B	015
Shell C: µCom plug - µCom plug cordset D: µCom plug - RJ45 Cat6A plug cordset E: µCom panel mount receptacle - RJ45 Cat6A plug cordset F: µCom plug - µCom inline receptacle cordset Open versions: G: µCom plug - no connector at the end H: µCom panel mount receptacle - no connector at the end J: µCom inline receptacle - no connector at the end						
Mating (for plugs only) T: thread						
Contacts termination C: crimp S: solder						
Shell plating B: black nickel G: olive drab cadmium U: unplated brass						
Total length - For other lengths, please consult us. 002: 20 cm [7.87] 005: 50 cm [19.68] 010: 1.0 m [39.37] 015: 1.5 m [59.05] 020: 2.0 m [78.74] 050: 5.0 m [196.85] 100: 10.0 m [393.70]						

For more information on µCom series, thanks to consult our dedicated datasheet

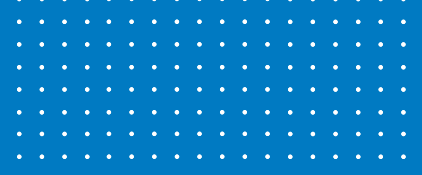

HIGH-SPEED CORDSETS

Thanks to our large contacts portfolio and expertise on major high speed protocols, Amphenol Socapex is now offering a capability of high-speed cordsets design and manufacturing. All cordsets are fully tested with test such as DWV, resistance and continuity. Other tests could be performed on demand.

High-speed cordsets



38999 connectors to RJ45



USB3 to SPLIT-PAIR QUADRAX

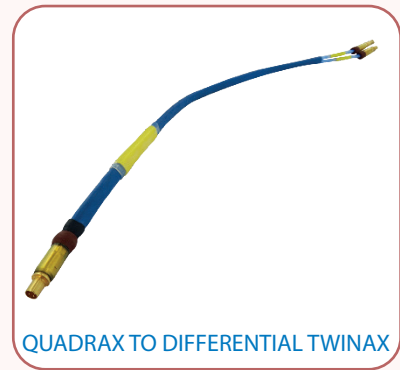

QUADRAX TO DIFFERENTIAL TWINAX

ASSEMBLY SHOP

A dedicated 400m² workshop and team focus on harnesses and cordsets manufacturing. Technical and manufacturing supports are available in France to help you on your definition.



M29504/4 & /5

FIBER OPTIC TERMINI

FEATURES AND BENEFITS

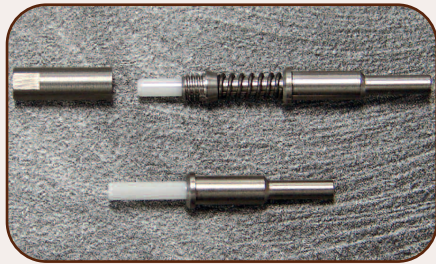

- Precision fiber optic ceramic ferrules
- Pre-radius ferrule design
- Precision “press fit” stainless steel design
- Accurate ferrule alignment system
- Size 16 design (MIL-DTL-38999 compatible)
- Low insertion loss and back reflection
- Designed and manufactured to MIL-PRF-29504/ 4 and /5 specifications

BENEFITS

- Solid reliable connectivity through a wide range of harsh environmental conditions
- Compatible with all qualified MIL-DTL-38999, Series III connectors.
- Fast termination and polish time
- Reliable, repeatable and durable connections
- Easy to clean

PRODUCT SPECIFICATIONS

- Solid reliable connectivity through a wide range of harsh environmental conditions
- Compatible with all qualified MIL-DTL-38999, Series III connectors.
- Fast termination and polish time
- Reliable, repeatable and durable connections
- Easy to clean

Specification	Measurement/Detail
Back Reflection	Better than -40 dB – PC polish Better than -50 dB – enhanced PC polish
Insertion Loss	0.45 typical (measured with 62.5/ 125 mm fiber @1310nm)
Operating Temperature	-65°C to +150°C
Temperature Life	+150°C for 1000 hours
Vibration	40 G random
Mechanical Shock	500 G
Mating Durability	500 cycles
Salt Spray	500 hours
Cable Retention Force	25 lbs (dependent on cable construction)

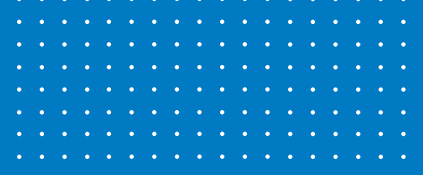

M29504/4 & /5

FIBER OPTIC TERMINI

ABOUT THE M29504

Amphenol Fiber Systems International's (AFSI) **M29504 /4 & /5** Style Fiber optic termini, the M29K1000 and M29L1000 series, provide superior optical and mechanical performance. Designed to fit into MIL-DTL-38999 Series III, pin size 16 connectors, this low-cost, high-precision terminus family is ideal for harsh environment fiber optic interconnections. Available for single mode and multimode applications these termini conform to the rigorous conditions of the MIL-PRF-29504B specification.

The M29K1000 and M29L1000 series termini utilize the highest quality Zirconia ceramic ferrules and split alignment sleeves available. AFSI's tight-tolerance ferrules are optimized for low insertion loss, low back reflection and exceptional durability. All ferrules are available in standard and ultra polished end faces for those tight optical budget applications. In addition, epoxy removal and polishing times are minimized by the ferrule's pre-domed design feature.

The M29L1000's Zirconia split alignment sleeve design ensures accurate physical contact, fiber-to-fiber alignment and guarantees the highest performing connector of its kind for use in a variety of demanding environmental conditions.

The M29K1000 and M29L1000 series fiber optic termination system offers precise, superior and reliable connections over repeated connector mating cycles and through a wide range of harsh environmental conditions.

M29504/4 FIBER SIZE TABLE

AFSI Pin Part Number	Fiber Size Core/Cladding	A Diam. (Microns)	Reference Only M29504 /4-XXXX
M29K2000	9/125	126	M29504/4-4209
M29K1001	50/125 & 62.5/125	126	M29504/4-4210
M29K1000	50/125 & 62.5/125	127	M29504/4-4040
M29K3000	100/140	142	M29504/4-4043
M29K3001	100/140	144	M29504/4-4044
M29K5000	62.5/125/155 (Polyimide)	156	M29504/4-4211
M29K5001	62.5/125/155 (Polyimide)	157	M29504/4-4212
M29K6000	100/140/172 (Polyimide)	173	M29504/4-4087
M29K6001	100/140/172 (Polyimide)	175	M29504/4-4213
M29K8000	200/233	236	M29504/4-4214
M29K8050	200/280	286	M29504/4-4215
M29K9000	400/440	448	M29504/4-4216

M29504/5 FIBER SIZE TABLE

AFSI Pin Part Number	Fiber Size Core/Cladding	A Diam. (Microns)	Reference Only M29504 /4-XXXX
M29L2000	9/125	126	M29504/5-4238
M29L1001	50/125 & 62.5/125	126	M29504/5-4239
M29L1000	50/125 & 62.5/125	127	M29504/5-4046
M29L3000	100/140	142	M29504/5-4049
M29L3001	100/140	144	M29504/5-4050
M29L5000	62.5/125/155 (Polyimide)	156	M29504/5-4240
M29L5001	62.5/125/155 (Polyimide)	157	M29504/5-4241
M29L6000	100/140/172 (Polyimide)	173	M29504/5-4088
M29L6001	100/140/172 (Polyimide)	175	M29504/5-4242
M29L8000	200/233	236	M29504/5-4243
M29L8050	200/280	286	M29504/5-4244
M29L9000	400/440	448	M29504/5-4245

LUX-BEAM®

SINGLE EXPANDED BEAM TERMINI

ABOUT LUX-BEAM®

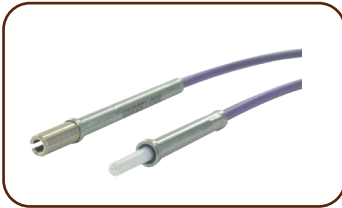

Lux-beam size 16

The new requirements for Avionics and Field communication systems demand for always higher amount of data, HD video transmission and higher bandwidth to be transmitted. Fiber optic technology is the technology of choice for those requirements.

With over 20 years of production of fiber optics expanded beam solutions, Amphenol introduces the **LUX-BEAM™** Single Expanded beam termini. A solution to upgrade the optical physical contact technology to an optical contactless technology.

LUX-BEAM™ is easy to clean, less sensitive to pollution by dust or debris. The contactless coupling of LUX-BEAM™ is not subject to degradation of performances resulting from friction of optical surfaces as it usual is on traditional butt joint termini. With its patented pin to socket realignment feature, LUX-BEAM™ is compatible with connectors from different suppliers and provides an efficient adjustment to tolerances during mating. Per design, LUX-BEAM™ is as easy to install.

FEATURES AND BENEFITS

Expanded Beam technology

- Surface expanded bundle >140X
- Reduced sensitivity to dust
- No degradation of the optical face
- Easy cleaning
- Low maintenance

Compatibility

- Cavity #16
 - MIL-DTL-38999 series III TV/CTV, EN3645
 - EN 4165 (SIM)

Other benefits technology

- Easy installation with standard tools
- Possibility to mix with Electrical contact for Hybrid solutions

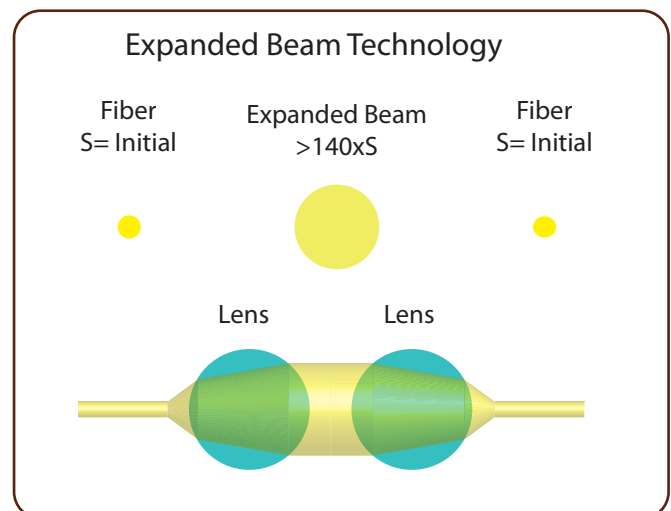

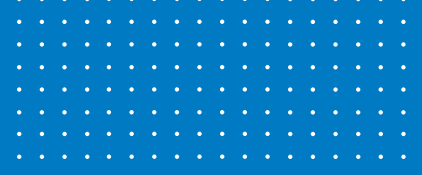

LUX-BEAM®

TECHNICAL DATA

SPECIFICATION	MEASUREMENT DETAILS	STANDARD	METHOD
Insertion loss	1.5dB max multimode, 850nm 1.5dB max multimode, 1300nm	MIL-PRF-29504D	TIA-455-34
Mating durability	500 cycles	MIL-DTL-38999	TIA-455-21
Operating temperature, temperature life	125°C 1000H	MIL-PRF-29504D	TIA-455-04
Storage temperature	-40°C / +85°C	MIL-PRF-29504D	
Temperature cycling	5 cycles -40°C +70°C	MIL-DTL-38999	TIA-455-03
Thermal shock	5 cycles -55°C +125°C	MIL-PRF-29504D	TIA-455-34
Humidity	24h at 50°C max 33% hum 240H at 40°C 90% RH	MIL-DTL-38999	TIA-455-05
Salt spray	48H	MIL-PRF-29504D	TIA-455-16
Vibration	Connectors mated Method B: Figure 2, Table 1, level J (1g2/Hz) Duration: 8h / axe – 2 axes longitudinal and perpendicular direction. Duration of micro-discontinuity : < 1µs IL max 2dB.	EN2591-6403	
Shock	Method A, severity 100 Number of shocks: 1 each way for each of the 2 directions (6 shocks in all). Duration of micro-discontinuity : < 1µs	EN2591-6402	
Insertion and removal force	max 22 pounds	MIL-PRF-29504D	3.6.9
Maintenance aging	10 insertions / removal cycles	MIL-PRF-29504D	3.6.13

HOW TO ORDER

Designation	LXB	16	P	A	18X
	LXB	16	S2	C	18X
Series LXB : LUX-BEAM, Single expanded beam optical termini					
Cavity size 16 : size 16 for 38999 series III					
Type of termini P : Pin termini S2 : Socket termini for series II S3 : socket termini for series III					
Wavelength A : optimised for wavelength 850nm (Multimode) B : optimised for wavelength 1300nm (Multimode) C : optimised for wavelength 850nm & 1300nm (Multimode)					
Cable 18X : for cable 1.8mm					

LUX-BEAM®

HOW TO ORDER CABLE ASSEMBLIES WITH LUX-BEAM™

CABLE ASSEMBLIES WITH LUX-BEAM™ TO OTHER TERMINI

Designation	LXB	16	P	A	1	D	1	L	0020	ST2	1	D	0	M
Type of Termini LXB: LUX-BEAM™, Single expanded beam optical termini														
Cavity size 16: size 16 for 38999 series III														
Type of termini P : pin termini S2 : socket termini for series II S3 : socket termini for series III														
Wavelength A: optimised for wavelength 850nm (Multimode) B: optimised for wavelength 1300nm (Multimode) C: optimised for wavelength 850nm & 1300nm (Multimode)														
Termination type 1: PC Ceramic														
Boot form D: straight boot														
Type of fiber 1: 50/125 Multimode 2: 62.5/125 Multimode														
Type of cable L: Simplex cable with buffer 900µm and outer jacket dia. 1.8mm														
Length XXXX: length in m for L ≥ 10m, ex 0020 for L=20 meters X.XX: length in m for L < 10m, ex 5.00 for L=5.0 meters														
Type of Termini XXX: pigtail ST2: connector ST2 954: connector SC simplex LCS: connector LC simplex ELU: connector ARINC 801 optical termini														
Termination type 1: PC Ceramic														
Boot form D: straight boot														
Protective Cap O: standard protective cap														
Marking : standard marking MX: specific marking														

Optical Contacts

LUMIÈRE

FIBER OPTIC TERMINI

ABOUT THE LUMIERE

Amphenol Fiber Systems International (AFSI) offers the **Lumière** fiber optic terminus for commercial airframe, avionics and aerospace applications. AFSI's Lumière termini are a direct replacement for ELIO® termini and are compatible with existing ELIO® connectors. This fiber optic contact utilizes a 2.5mm diameter field-proven ceramic ST type ferrule which can be inserted into a size #16 cavity.

The terminus is hermaphroditic allowing the use of the same contact on the receptacle or plug. In addition, the contact is available in both multi-mode and single mode versions and an anti-rotation feature allows PC, UPC and APC polishes. Because the Lumière uses a standard ST type ferrule, well known procedures and readily available tools can be used for termination. Long and short boot versions are available to support multiple connector types.

Amphenol also manufactures a full line of EN 4531 rectangular and cylindrical connectors to house the Lumière termini.

FEATURES AND BENEFITS

- Hermaphroditic style allows one contact type
- Standard 2.5mm ST type ferrule interface allows the use of standard termination procedures and readily available tools
- Simple access to optical termini facilitates cleaning
- Options available for single mode and multimode fiber
- Pull Proof option allows the use of the terminus in a connector without a backshell
- Supports both tight or loose structure cable



OPTICAL PERFORMANCE

Typical IL: 0.3dB SM, 0.2dB MM @ 1300nm

Typical Return Loss: -30dB SM and MM @ 1300nm

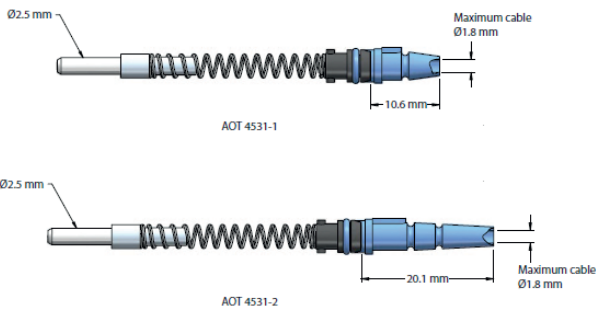

Part Number	Description
AOT 4532-1	Lumière-S, Short Boot
AOT 4531-2	Lumière-L, Long Boot

ARINC 801

FIBER OPTIC TERMINI

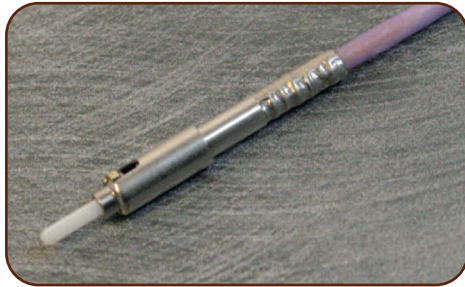

ABOUT ARINC 801 TERMINI

Amphenol Fiber Systems International (AFSI) offers the fully-compliant [ARINC 801 fiber optic terminus](#) for aerospace applications. The AFSI ARINC 801 uses a standard 1.25 mm ferrule and sleeve and can be terminated with standard LC termination procedures. The terminus can be inserted, or removed, from the connector with a standard size 16 removal tool.

The terminus is available in both multimode and single mode versions. The fiber optic contact provides low insertion loss (0.3 dB max) and backreflection (-50 dB). In addition to the standard PC end-face option, AFSI's ARINC 801 is offered with an APC end-face for those applications requiring lower backreflection.

The terminus is highly flexible and is used primarily in ARINC 801, 600, 404, 781 and EPXA/B multichannel connectors. The fiber optic contact is offered in an optional pull-proof (allows the use of the contact in a connector without a strain-relief backshell) configuration and an optical disconnect style for tight jacket cable.

FEATURES AND BENEFITS

- Flexible design for use in multiple connector types
- Genderless terminus allows one contact type
- Standard 1.25 mm LC ferrule interface allows the use of standard termination procedures and widely available tools
- Options available for single mode and multimode fiber in PC or APC polishes
- Pull-proof option allows the use of the terminus in a connector without a backshell
- Works with tight or loose structure cable
- All stainless steel option available

Specification	Measurement/Detail
Insertion Loss	0.3 dBmax (multimode) 0.5 dBmax (singlemode)
Operating Temperature	-55° C to +85° C
Connector Format	ARINC 600, 404, 781&801;MIL-DTL-82527 type; MIL-DTL-38999
Mating	100 mate/demate cycles
Cable OD Supported	1.55 mm to 2.2 mm

ACCESSORIES

Amphenol provides a full range of accessories as:

Sealing plugs: to be mounted behind the crimp contacts

Dummy contacts: to be mounted instead of the contacts

Piggy Back Grommets: To insure back contact sealing when using size 8 power, coax, twinax or quadrax. Those piggy back grommets are only compliant with tower grommet style

SEALING PLUGS

Contact size	Proprietary No	Military No
8 power	900024	-
12	900023	MS27488-12-2
16	900020	MS27488-16-2
20	900021	MS27488-20-2
22D	900022	MS27488-22-2
23	900022	MS27488-22-2

DUMMY CONTACTS

Contact size	Dummy contact material	Proprietary No
4	White plastic	900329
8	Green plastic	900488
8	Brass + gold finish	900183
8	White plastic (recommended)	900029
12	Brass + gold finish	900025
12	White plastic	900486
16	Brass + gold finish	900028
16	Blue plastic	900026
20	Brass + gold finish	900332

Metal dummy contacts are recommended for applications requesting EMI protection.

PIGGY BACK GROMMET

Type of contact	Cable OD (mm)	Proprietary No
Size 8 power	4.4 to 5.2	900471
Size 8 twinax and coax	3 to 4.4	900472
Size 8 twinax and coax	3 to 4.4	900476*
Quadrax	3 to 4.4	603015
	4.4 to 5.2	603016

* to use for arrangements 25-20, 19-17

ACCESSORIES

REDUCING FERRULE

Reducing ferrule No	Contact size	Wire Gauge	Pin contacts	Socket contacts	Crimping tool	Selector position	Type
900154	8	10	900197/ 900198	900217	809872+809873	6	1
900092	12	16			M22520/1-01+ M22520/1-04	7	2
		18				6	
		20				5	
900093		20				6	2
		22				6	
		24				5	
900091	16	24			M22520/2-01 + M22520/2-09 or M22520/2-07	4	2
		26				4	
		28				3	
900090	20	26			M22520/2-01 + M22520/2-09 or M22520/2-07	2	2
		28				2	
900099	22D	30	900004	900044	M22520/2-01 + M22520/2-09 or M22520/2-07	4	2
900094		32				5	2
		34				4	

The sealing of mated connectors is only guaranteed for the minimum wire outside diameter given in the table page 7

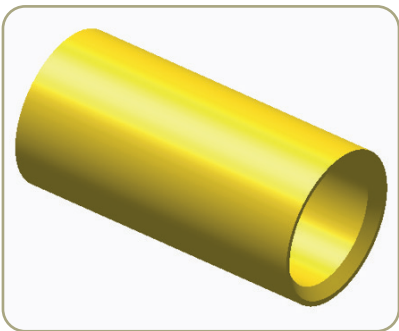

Type 1

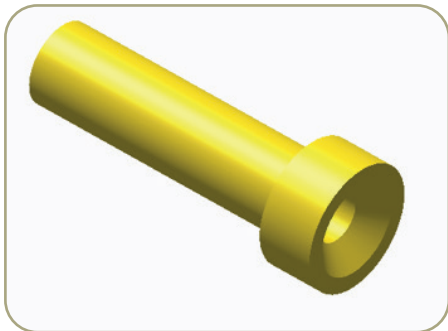

Type 2

GLOSSARY

INSERTION FORCE:

It's force resulting when the pin contact get engaged in the socket contact. It's usually given in Newtons

INSULATOR:

It's the plastic components located between contacts for multi-part contacts (COAX, TWINAX, QUADRAX). There could be multiple insulators per contacts.

ELECTRICAL IMPEDANCE (or IMPEDANCE):

Electrical impedance, or simply "impedance," describes a measure of opposition to alternating current (AC). Electrical impedance extends the concept of resistance to AC circuits, describing not only the relative amplitudes of the voltage and current, but also the relative phases. When the circuit is driven with direct current (DC), there is no distinction between impedance and resistance; the latter can be thought of as impedance with zero phase angle.

VOLTAGE STANDARD WAVE RATIO (or VSWR):

It's used to measure the efficiency of a transmission line. The value is expressed as a ratio with 1 (1:1, 2:1, 3:1). A perfect transmission line would be 1:1.

CRIMPING TOOL:

The crimping tool is the tool used to crimp the wire into the contact. It's usually used with a additional component called positioner or die sets.

FREQUENCY RANGE:

It's define the better range of frequency in utilisation to obtain the better performance of the couple cable + contact.

INSERTION LOSS:

It's the difference between the amount of data has been sent versus the data received.

POSITIONER:

This complementary component of crimping tool is used to guide, locate the crimping area of the contact during the crimping operation.

DIE SET:

This complementary component of crimping tool defines the hexagonal crimping die.

GLOSSARY

PIGGY BACK GROMMET:

The piggy back grommet is an additional device for contact size 8 which provide sealing on the wire and also guiding of the contact in the connector.

DATA RATE:

Data rate is the number of "bits" of data transferred per a given unit of time.

BANDWIDTH:

Is the difference between the upper and lower frequencies in a continuous set of frequencies.

DURABILITY:

Is the number of mating cycle admissible by the contacts.

RF LEAKAGE:

Is defined as the amount of energy which "leaks" from the connector and/or component. Although RF Leakage will vary with frequency, it is typically tested at only one frequency. Leakage, like Insertion Loss, is expressed in dB. Very large negative dB values indicate that the device does not radiate much energy.

DIFFERENTIAL PAIR:

Differential signaling is a method of transmitting information electrically with two complementary signals sent on two paired wires, called a differential pair.

CONTACT AND CABLE SELECTION GUIDE

COAXIAL PIN

Contact and Cable Selection Guide

Cable	Impedance	Contact Size		Standard	P/N	Impedance Match	Most Appropriate		Connector				
							Contact Size vs Cable	Frequency	MIL-DTL-38999			EN3645	EN4165 Standard
									Series I	Series II	Series III		
RG-58C/U (M17/028-RG058)	50	8			600901				X	X	X	X	X
RG-58 (M17/155-00001)	50	8			600901				X	X	X	X	X
RG-142B/U (M17/060-RG142)	50	8			900136				X	X	X	X	X
RG-161/U	70	16	*	M39029/76-424	071094		X		X	X	X	X	X
		12		M39029/28-211	900340				X	X	X	X	X
		8			900135				X	X	X	X	X
RG-174A/U (M17/119-RG174)	50	16	*	M39029/76-424	071094		X		X	X	X	X	X
		12		M39029/28-211	900340				X	X	X	X	X
		8			900135				X	X	X	X	X
RG-178B/U (M17/093-RG178)	50	16	*	M39029/76-425	070247		X		X	X	X	X	X
		12	*		600907	X		X	X	X	X	X	X
RG-179B/U (M17/094-RG179)	75	16	*	M39029/76-424	071094		X		X	X	X	X	X
		12		M39029/28-211	900340	X		X	X	X	X	X	X
		8	*		600822	X (3G-SDI)		X	X	X	X	X	X
		8			900135			X	X	X	X	X	X
RG-180B/U (M17/095-RG180)	95	6			600757	X			X	X	X		
		12	*	M39029/28-409	900341		X		X	X	X	X	X
		8		M39029/60-367	900130				X	X	X	X	X
RG-187A/U (M17/094-RG179)	75	16	*	M39029/76-424	071094		X		X	X	X	X	X
		12		M39029/28-211	900340				X	X	X	X	X
		8			500135				X	X	X	X	X
RG-188A/U (M17/113-RG316)	50	16	*	M39029/76-424	071094		X		X	X	X	X	X
		12		M39029/28-211	900340				X	X	X	X	X
		8			900135				X	X	X	X	X
RG-195A/U (M17/095-RG180)	95	12	*	M39029/28-409	900341		X		X	X	X	X	X
		8			900130				X	X	X	X	X
RG-196A/U (M17/169-00001)	50	16	*	M39029/76-425	070247		X		X	X	X	X	X
RG-223/U (M17/084-RG223)	50	8			900136				X	X	X	X	X
RG-316/U (M17/113-RG316)	50	16	*	M39029/76-424	071094				X	X	X	X	X
		12		M39029/28-211	900340				X	X	X	X	X
		12	*		900384	X		X	X	X	X	X	X
		8			900135			X	X	X	X	X	X
RD-316	50	12	*	M39029/103	900385	X		X	X	X	X	X	X
		8			900137			X	X	X	X	X	X
(M17/152-00001)	50	8	*	M39029/103	900385	X		X	X	X	X	X	X
RG-400 (M17/128-RG400)	50	8			900138				X	X	X	X	X
		8	*		600922	12GHz		X	X	X	X	X	X
TFLEX-402	50	8			600923	18GHz			X	X	X	X	X
		8	*		600606	26,5GHz		X	X	X	X	X	X
TFLEX-405	50	12	*		600924	65GHz	X	X	X	X	X	X	X
		8			600921	18GHz			X	X	X	X	X
		8			600600	26,5GHz			X	X	X	X	X
		8	*		600920	40GHz		X	X	X	X	X	X
Filotex ET124962	50	12		M39029/103	900385	X		X	X	X	X	X	
PAN6422XQ	75	12			600906	X		X	X	X	X	X	
Belden RG59 0,8/3,7	75	6			600813	X		X	X	X	X	X	
Draka HD PRO 0,8/3,7 AF	75	6			600813	X		X	X	X	X	X	
Haveg 61-02051		16			900186			X	X	X	X	X	
Haveg 8100207		16		M39029/76-424	071094		X		X	X	X	X	X
		12		M39029/28-211	900340				X	X	X	X	X

CONTACT AND CABLE SELECTION GUIDE

COAXIAL PIN

Cable	Impedance	Contact Size	Standard	P/N	Impedance Match	Most Appropriate		Connector				
						Contact Size vs Cable	Frequency	MIL-DTL-38999			EN3645	EN4165 Standard
								Series I	Series II	Series III		
Grun 0,6/3,7	75	6		600813				X	X	X	X	X
Gore GWN1159A		12		900428				X	X	X	X	X
Gore CXN340		12		600907	X			X	X	X	X	X
Times AA3248		16	*	M39029/76-424	071094	X		X	X	X	X	X
		12		M39029/28-211	900340			X	X	X	X	X
		8			900135			X	X	X	X	X
Times LMR-195-UF		8		600901				X	X	X	X	X
Teledyne 11299		16	*	M39029/76-424	071094		X	X	X	X	X	X
		12			900340			X	X	X	X	X
		8			900135			X	X	X	X	X
Raychem 5021D13311-0	50	8		600904				X	X	X	X	X
Raychem 5021D1331-0				600902				X	X	X	X	X
Raychem 5022E5111		12		900424				X	X	X	X	X
Raychem 9528A1318	75	16	*	M39029/76-424	071094		X	X	X	X	X	X
		12		M39029/28-409	900341			X	X	X	X	X
Raychem7528H1424		12		M39029/28-211	900340			X	X	X	X	X
Raychem 9528A1318	95	12	*		071954		X	X	X	X	X	X
		8		M39029/60-367	900130			X	X	X	X	X
Raychem 9530A5314	95	12		900426				X	X	X	X	X
Tensolite 28895/2X1		8		600900				X	X	X	X	X
ESC432101		8		600903				X	X	X	X	X
ECS3C058A		8		900138				X	X	X	X	X
ECS352001		8		900138				X	X	X	X	X
ECS432101		8		900138				X	X	X	X	X
PIC V75268	75	8		600830	X			X	X	X	X	X
PIC V75248		8		600830	X			X	X	X	X	X
PIC V75261	75	8		600830	X			X	X	X	X	X
PIC V73263	75	8		600830	X			X	X	X	X	X
EMTQ TFLEX 125-075.01	75	8		600830	X			X	X	X	X	X

*Mean the best match between cable and contacts

CONTACT AND CABLE SELECTION GUIDE

COAXIAL SOCKET

Cable	Impedance	Contact Size		Standard	P/N	Impedance Match	Most Appropriate		Connector					
							Contact Size vs Cable	Frequency	MIL-DTL-38999			EN3645	EN4165	
									Series I	Series II	Series III		Standard	Series III
RG-58C/U (M17/028-RG058)	50	8			600911				X		X	X		X
RG-58 (M17/155-00001)	50	8			600911				X		X	X		X
RG-142B/U (M17/060-RG142)	50	8			900146				X		X	X		X
RG-161/U	70	16	*	M39029/78-432	077987		X			X			X	
		16	*	M39029/77-428	070248		X			X	X			
		12		M39029/27-210	900354					X			X	
		12		M39209/75-416	900350					X	X	X		
		8			900145					X	X	X		X
RG-174A/U (M17/119-RG174)	50	16	*	M39029/78-432	077987		X			X			X	
		16	*	M39029/77-428	070248					X	X			
		12		M39029/27-210	900354					X			X	
		12		M39209/75-416	900350					X	X	X		
		8			900145					X	X	X		X
RG-178B/U (M17/093-RG178)	50	16	*	M39029/78-433	071998		X			X			X	
		12			600659	X					X			
		16		M39029/77-429	071965					X		X		X
		12	*		600917	X		X	X	X	X			
RG-179B/U (M17/094-RG179)	75	16	*	M39029/78-432	077987		X			X			X	
		12		M39029/27-210	900354					X			X	
		12		M39209/75-416	900350					X	X	X		
		8	*		600841	X (3G-SDI)		X	X	X	X		X	
		8			900145				X		X	X		X
RG-180B/U (M17/095-RG180)	95	6			603180	X				X	X	X		
		12	*	M39029/27-402	900286		X			X			X	
		12	*	M39029/75-417	900351		X			X	X	X		
		8		M39029/59-366	900140					X	X	X		X
RG-187A/U (M17/094-RG179)	74	16	*	M39029/78-432	077987		X			X			X	
		16	*	M39029/77-428	070248		X			X	X			
		12		M39029/27-210	900354					X			X	
		12		M39029/75-417	900351		X			X	X	X		
		8			900145					X	X	X		X
RG-188A/U (M17/113-RG316)	50	16	*	M39029/78-432	077987		X			X			X	
		16	*	M39029/77-428	070248		X			X	X			
		12		M39029/27-210	900354					X			X	
		12		M39029/75-417	900351		X			X	X	X		
		8			900145					X	X	X		X
RG-195A/U (M17/095-RG180)	95	12	*	M39029/27-210	900354					X			X	
		12	*	M39029/75-417	900351		X			X	X			
		8			900140					X	X	X		X
RG-196A/U (M17/169-00001)	50	16		M39029/78-433	071998		X			X			X	
		16		M39029/77-429	071965					X			X	
RG-223/U (M17/084-RG223)	50	8			900146					X		X	X	
RG-316/U (M17/113-RG316)	50	16	*	M39029/78-432	077987		X			X			X	
		16	*	M39029/77-428	070248		X			X	X			
		12		M39029/27-210	900354					X			X	
		12		M39209/75-416	900350					X	X	X		
		12	*		600750	X		X		X				
RD-316 (M17/152-00001)	50	12	*	M39029/102	900395	X		X		X	X	X	X	X
		8			900147					X	X	X		X
RG-400 (M17/128-RG400)	50	8			900148					X	X	X		X
		8	*		600927	12GHz		X		X	X	X		X
TFLEX-402	50	8			600919	18GHz				X	X	X		X
		8	*		600581	26,5GHz		X		X	X	X		X

Contact and Cable Selection Guide

CONTACT AND CABLE SELECTION GUIDE

COAXIAL SOCKET

Cable	Impedance	Contact Size		Standard	P/N	Impedance Match	Most Appropriate		Connector					
							Contact Size vs Cable	Frequency	MIL-DTL-38999			EN3645	EN4165	
									Series I	Series II	Series III		Standard	Series III
TFLEX-405	50	12	*		600928	65GHz	X	X	X	X	X	X		
		8			600926	18GHz			X		X	X		X
		8			600580	26,5GHz			X		X	X		X
		8	*		600925	40GHz		X	X		X	X		X
Filotex ET124962	50	12		M39029/102	900395	X		X		X	X	X		
PAN6422XQ	50	12			600916	X		X		X	X	X		
Belden RG59 0,8/3,7	75	6			600715	X		X	X	X	X			
Draka HD PRO 0,8/3,7 AF	75	6			600715	X		X	X	X	X			
Haveg 61-02051		16			900187				X				X	
		16			603247			X		X	X			
Haveg 8100207		16	*	M39029/78-432	077987		X		X				X	
		16	*	M39029/77-428	070248		X		X		X			
		12		M39029/27-210	900354				X				X	
		12		M39209/75-416	900350				X		X	X		
Grun 0,6/3,7	75	6			600715			X	X	X	X			
Gore GWN1159A		12			900429				X				X	
		12			900075			X		X	X			
Gore CXN3403		12			600917	X		X	X	X	X	X		
Times AA3248		16	*	M39029/78-432	077987		X		X				X	
		16	*	M39029/77-428	070248		X		X		X			
		12		M39029/27-210	900354				X				X	
		12		M39209/75-416	900350				X		X	X		
		8			900145				X		X	X		X
Times LMR-195-UF		8			600911			X		X	X		X	
Teledyne 11299		16		M39029/78-432	077987		X		X				X	
		16		M39029/77-428	070248		X		X		X			
		12		M39029/27-210	900354				X				X	
		12		M39209/75-416	900350				X		X	X		
		8			900145				X		X	X		X
Raychem 5021D13311-0	50	8			600914			X		X	X		X	
Raychem 5021D1331-0		8			600912			X		X	X		X	
Raychem 5022E5111		12			900425			X	X	X	X		X	
Raychem 7527A1318	75	16	*	M39029/78-432	077587		X		X				X	
		16	*	M39029/77-428	070248		X		X		X			
		12		M39029/27-210	900354				X		X	X		
		12		M39209/75-416	900350				X		X	X		
Raychem 7528H1424		12		M39029/27-210	900354				X		X	X		X
		12		M39209/75-416	900350				X		X	X		
Raychem 9528A1318	95	12	*		900420		X		X				X	
		12	*		900430		X		X		X	X		
		8		M39029/59-366	900140				X		X	X		X
Raychem 9530A5314	95	12			900427				X				X	
		12			900422				X		X	X		X
Tensolite 28895/2X1		8			600910				X		X	X		X
ESC432101		8			600913				X		X	X		X
ECS3C058A		8			900148				X		X	X		X
ECS352001		8			900148				X		X	X		X
ECS432101		8			900148				X		X	X		X
PIC V75268		8			600836	X			X		X	X		X
PIC V75248		8			600836	X			X		X	X		X
PIC V75261		8			600836	X			X		X	X		X
PIC V73263		8			600836	X			X		X	X		X
EMTQ TFLX 125-075-01		8			600836	X			X		X	X		X

Contact and Cable Selection Guide

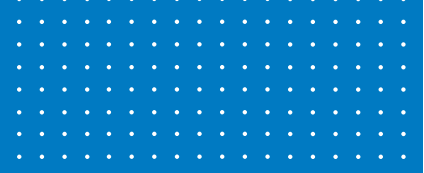

CONTACT AND CABLE SELECTION GUIDE

TWINAX PIN AND SOCKET

Cable	Impedance	Contact Size	Standard	P/N		Concentric - differential	Protocol	Connector				Sim Connector Series III
				PIN	SKT			MIL-DTL-38999			EN3645	
								Series I	Series II	Series III		
M17-176-0002	77	8	AS39029/90-529	074834	072453	CONCENTRIC	BUS1553	X		X	X	X
		8	AS39029/113-625			CONCENTRIC	BUS1553	X		X	X	X
		8		900937	900938	DIFFERENTIAL		X		X	X	X
		8	711-1760-104			CONCENTRIC	BUS1553	X		X	X	X
EN3375-003 KG24	77	8	EN3155-024M08AB	600611	600614	CONCENTRIC	BUS1553	X		X	X	X
EN3375-004 WJ24	77	8	EN3155-024M08BB	600612	600615	CONCENTRIC	BUS1553	X		X	X	X
			ABS2217P03	600858	600859	CONCENTRIC	BUS1553	X		X	X	X
		8 (ARINC)	ABS1600M08A	140675	140683	CONCENTRIC	BUS1553	ARINC CONNECTOR				
EN3375-005 WV24	77	8	EN3155-024M08CB	600613	600616	CONCENTRIC	BUS1553	X		X	X	X
EN3375-006 XM24	78	8		600856	600857	CONCENTRIC	BUS1553	X		X	X	X
EN3375-009 WS26	120	8	ABS2217P01	600854	600855	CONCENTRIC		X		X	X	X
Raychem 10612	77	8	711-1060-104			CONCENTRIC	BUS1553	X		X	X	X
Raychem 10613	77	8	711-1760-102			CONCENTRIC	BUS1553	X		X	X	X
Raychem 10614	77	8	711-1760-101			CONCENTRIC	BUS1553	X		X	X	X
EPD44690	77	8	711-1760-104			CONCENTRIC	BUS1553	X		X	X	X
EPD44691	77	8	711-1760-104			CONCENTRIC	BUS1553	X		X	X	X
EPD44692	77	8	711-1760-101			CONCENTRIC	BUS1553	X		X	X	X
EPD44695	77	8	711-1760-101			CONCENTRIC	BUS1553	X		X	X	X
PAN 6421	77	8	711-1760-102			CONCENTRIC	BUS1553	X		X	X	X
Mc Donnell Douglas SM2022/003	77	8	711-1760-103			CONCENTRIC	BUS1553	X		X	X	X
ASNE08072003-09	100	8		600933	600934	DIFFERENTIAL	ETHERNET USB	X		X	X	X
AXON P509782	100	8		600943	600944	DIFFERENTIAL		X		X	X	X
Tensolite 24463/05099X-8(LD)	100	8		900418	900419	DIFFERENTIAL	ETHERNET USB	X		X	X	X
Tensolite 24463/9P025X-2(LD)	100	8		900418	900419	DIFFERENTIAL	ETHERNET USB	X		X	X	X
Tensolite 26453/03184X-2(LD)	100	8		600933	600934	DIFFERENTIAL	ETHERNET USB	X		X	X	X
Tensolite 24460/05114X-2(LD)	100	8		600935	600934	DIFFERENTIAL	ETHERNET USB	X		X	X	X
Tensolite 24463/03220T-2 (LD)	100	8		600939	600940	DIFFERENTIAL	ETHERNET USB	X		X	X	X
Tensolite 26453/03184X-2(LD)	100	8		600945	600946	DIFFERENTIAL		X		X	X	X
Tensolite 26483/03071X-2(LD)	150	8		900294	900299	DIFFERENTIAL		X		X	X	X
				600858	600899	DIFFERENTIAL	FIBRE CHANNEL ETHERNET 1000BASE-T	X		X	X	X
Thermax MX 100-24	100	8		900418	900419	DIFFERENTIAL	ETHERNET	X		X	X	X
Thermax 12814	100	8		900418	900419	DIFFERENTIAL	ETHERNET	X		X	X	X
Thermax 956-626Z	100	8		600933	600934	DIFFERENTIAL	ETHERNET USB	X		X	X	X
Thermax 956-1T200	100	8		600931	600932	DIFFERENTIAL	ETHERNET USB	X		X	X	X
ST5M1 284-003	98	8		900418	900419	DIFFERENTIAL	ETHERNET USB	X		X	X	X
26463/70460X-2	98	8		900418	900419	DIFFERENTIAL	ETHERNET USB	X		X	X	X
PIC E10224	100	8		900418	900419	DIFFERENTIAL	ETHERNET USB	X		X	X	X
PIC E1024	100	8		600935	600936	DIFFERENTIAL	ETHERNET USB	X		X	X	X
Draka 2709-3	100	8		900418	900419	DIFFERENTIAL	ETHERNET USB	X		X	X	X
NF24T100-200C	100	8		900418	900419	DIFFERENTIAL	ETHERNET USB	X		X	X	X
S280W502-1	100	8		900418	900419	DIFFERENTIAL	ETHERNET USB	X		X	X	X
S280W502-6	100	8		600941	600942	DIFFERENTIAL	ETHERNET USB	X		X	X	X
GORE GSC-05-827300-00	100	8		600931	600932	DIFFERENTIAL	ETHERNET USB	X		X	X	X
GORE DXN 2125	100	8		600947	600948	DIFFERENTIAL		X		X	X	X
JSFY11-24	100	8		600939	600940	DIFFERENTIAL	ETHERNET USB	X		X	X	X

Contact and Cable Selection Guide

ABOUT AMPHENOL

Founded in 1932, **Amphenol** is one of the largest manufacturers of interconnect products in the world. The company designs, manufactures, and markets electrical, electronic, and fiber optic connectors, interconnect systems, and coaxial and specialty cables.

Amphenol has a diversified presence as a leader in high growth areas of the interconnect industry and provides solutions for customers in the automotive, broadband, industrial, information technology and data communications, military and aerospace, mobile devices, and mobile networks markets.

More info on www.amphenol.com

Amphenol
ENABLING THE ELECTRONICS REVOLUTION

Amphenol Military & Aerospace Operations (AMAO) has the largest and broadest selection of interconnect products in the military and aerospace markets.

More info on www.amphenolmao.com

Amphenol
MILITARY & AEROSPACE

Europe

FRANCE	Amphenol AIR LB	2 rue Clément Ader, ZAC de Wé - 08110 Carignan	+33 3 24 22 78 49
FRANCE	Amphenol SEFEE	Z.I. des Cazes – BP243 - 12402 Saint-Affrique Cedex	+33 5 65 98 11 00
GERMANY	Amphenol AIR LB GMBH	Am Kleinbahnhof 4 - 66740 Saarlouis	+49 6831 981 00
ITALY	Amphenol EUROPEAN SALES OPERATIONS	Via Barbaiana n.5 - 20020 Lainate - Milano	+39 293 254 214
UNITED KINGDOM	Amphenol INVOTEC	Unit 1-3, Hedging Lane Industrial Estate, Dosthill - Tamworth, B77 5HH	+44 1827 263 000
UNITED KINGDOM	Amphenol IONIX SYSTEMS	Prospect House, Taylor Business Park, Risley, Warrington, WA3 6HP	+44 1 942 685 200
UNITED KINGDOM	Amphenol LTD	Thanet Way, Whitstable - KENT, CT53JF	+44 1227 773 200
UNITED KINGDOM	Amphenol MARTEC	St Augustines Business Park, Swalecliffe Whitstable - Kent CT5 2QJ	+44 1227 793 733

North America

CANADA	Amphenol CANADA	605 Milner avenue - Toronto, Ontario	+1 416 291 0647
USA	Amphenol AEROSPACE OPERATIONS	40-60 Delaware street - Sidney, NY 13838	+1 800 678 0141
USA	Amphenol BORISH TECHNOLOGIES	4511 East Paris AVE - Grand Rapids, MI 49512	+1 616 554 9820
USA	Amphenol FSI	1300 Central Expwy N, Suite 100 - Allen, TX 75013	+1 214 547 2400
USA	Amphenol GRIFFITH ENTERPRISES	6000 East Coury Drive - Cottonwood, AZ 86326	+1 928 634 3685
USA	Amphenol NEXUS TECHNOLOGIES	50 Sunnyside Avenue - Stamford, CT 06902	+1 203 327 7300
USA	Amphenol PCD	72 Cherry Hill Drive - Beverly, MA. 01915	+1 978 624 3400
USA	Amphenol PRINTED CIRCUIT	Board Technology, 91 Northeastern Boulevard - Nashua, NH 03062	+1 603 324 4500
USA	Amphenol SV MICROWAVE	2400 Centrepark West Drive - West Palm Beach, FL	+1 561 840 1800
USA	Amphenol TIMES MICROWAVE	358 Hall Avenue - Wallingford, CT 06492	+1 800 867 2629

Asia

CHINA	Amphenol PCD CO.	Building 21, 1 st Liao Keng Industrial Zone, Shi Yan Street - Bao An District - Shenzhen 518108	+86 755 8173 8000/8286
INDIA	Amphenol INTERCONNECT INDIA	105 Bhosari Industrial Area - Pune 411 026	+91 20 27120363
JAPAN	Amphenol JAPAN	471-1, Deba, Ritto-City - Shiga 520 3041	+81 77 553 8501
KOREA	Amphenol DAESHIN	558 SongNae-Dong SoSa-Gu, Bucheon-city, Kyunggi-Do - 420-130	+81 32 610 3830/3845
SINGAPORE	Amphenol EAST ASIA	26/F, Railway Plaza, 39 Chatham Road South, Tsim Sha Tsui, Kowloon, Hong Kong	+65 6294 2128

Other Areas

AFRICA	Amphenol AFRICA	30 Impala Rd - Sandton 2146	+27 82 410 5179
ARGENTINA	Amphenol ARGENTINA	Av. Callao 930 2do piso Oficina B "Plaza" C1023 - AAP Buenos Aires	+54 11 4815 6886
AUSTRALIA	Amphenol AUSTRALIA PTY	2 Fiveways Blvd., Keysborough - Melbourne - Victoria 3173	+61 3 8796 8888
BRAZIL	Amphenol DO BRAZIL	Rua Diogo Moreira, 132, 20 andar, rooms 2001-2-3	+55 11 3815 1003
ISRAEL	Amphenol BAR-TEC	3 Hagavish Street, K fir-Barkan Bldg. East Industrial Zone - Kfar-Sava, 44102	+972 9 764 4100
MEXICO	Amphenol OPTIMIZE	Carretera Internacional Km 6.5, Col. Parque Industrial, Nogales, Sonora, C.P. 84094	+52 631 311 160
NEW ZEALAND	Amphenol PHITEK	Level 4, 2 Kingdon Street, Newmarket, Auckland 1023	+64 9 524 2984
RUSSIA	Amphenol RUSSIA	Yaroslavskaja Street 8 - 129164 Moscow	+7 495 937 6341
TURKEY	Amphenol TURKEY	Sun Plaza 15 Kat: 15 Maslak Hah. Bilim Sok. No.5 - Sisli/Istanbul, 34398	+90 212 367 92 19

Amphenol SOCAPEX



Amphenol Socapex

948, promenade de l'Arve BP29
74311 Thyez Cedex - France
Phone: +33 (0)4 50 89 28 00
contact@amphenol-socapex.fr
www.amphenol-socapex.com



For Technical Support

+33 (0)4 50 89 28 49
technicalsupport@amphenol-socapex.fr
www.amphenol-socapex.com/technical_support



To buy our products

+33 (0)4 50 90 28 00
contact@amphenol-socapex.fr
www.amphenol-socapex.com/amphenol/sales
Request a quote online at www.amphenol-socapex.com/quotation_request







Documentation

www.amphenol-socapex.com/documentation
To order a paper version of our catalogs, send an e-mail to communication@amphenol-socapex.fr



www.amphenol-socapex.com

Follow Amphenol Socapex on social media :    

This catalog uses paper from managed forests, PEFC & FSC labels, and is printed by a printer certified "Imprim'Vert®"

*We reserve the right to modify our products in any way we deem necessary.
Any duplication is prohibited, unless approved in writing.*

Designed by Amphenol Socapex
DOC-000081-ANG - March 2020