

Disc-Type Handwheels • DIN 3670

24570.0305

Product Description

There are gripping indentations on the rear sides.
Hub machined; rim turned and mirror-finished on all sides, non-machined surfaces cleanly blasted.



Material

Handwheel

- Aluminium permanent-mould casting

Assembly

Shaft-end washers EH 22270. for axial fastening.

More information

Further products

- Shaft-End Washers

Drawing

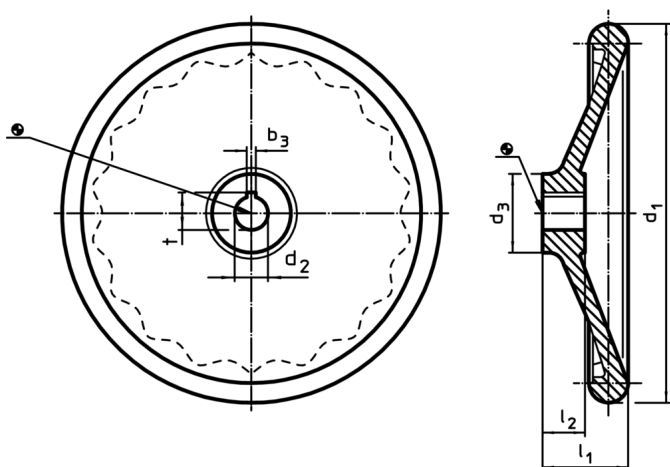

The orientation of the hub keyway may be different than shown in the drawing.

Order information

d ₁	d ₂ H7	Dimensions			Hub keyway, DIN 6885 sheet 1		[g]	Art. No.
		d ₃	l ₁	l ₂	b ₃	t		
		[mm]			[mm]			
without steel bushing, form N, with keyway								
100	10	28	33	17	3	11.4	244	24570.0305

Application example

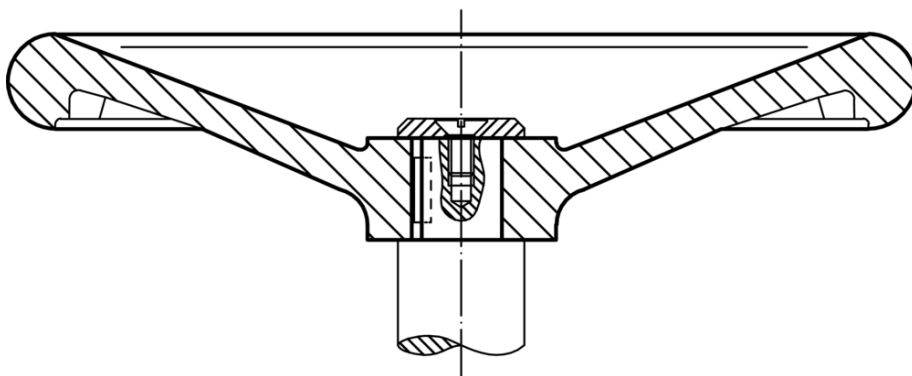

Compliance

RoHS compliant

Contains lead - compliant according to exceptions 6a / 6b / 6c

Contains SVHC substances >0,1% w/w

Contains lead - SVHC list [REACH] as of 10.06.2022

Contains Proposition 65 substances



Lead can cause cancer and reproductive harm from exposure

<https://www.P65Warnings.ca.gov/>

Free from Conflict Minerals

This product does not contain any substances designated as "conflict minerals" such as tantalum, tin, gold or tungsten from the Democratic Republic of Congo or adjacent countries.