



Datenblatt - Fiche technique - Data sheet

11.04.5303



ROLINE VGA-Kabel HD15 ST - BU, 3,0m

ROLINE Câble HD15 M/HD15 F, 3,0m

ROLINE HQ VGA Cable, HD15, M/F, 3 m

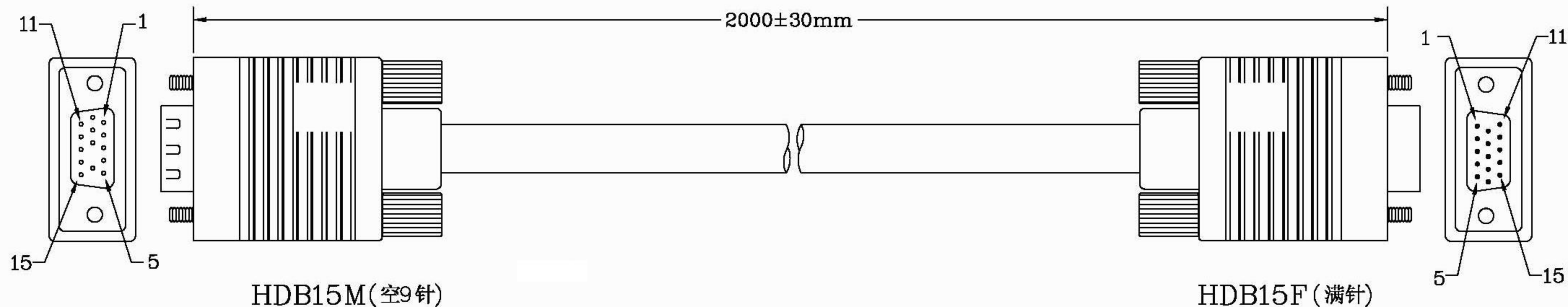

料号	颜色	长度
11.04.5302	BLACK	2000MM
11.04.5303	BLACK	3030MM

NOTE:

1. CABLE: 28AWG, UL2919, AL+B-FOIL, 3同轴+7C(26AWG), 黑色, 齿状, OD=9.0mm. PVC JACKET
2. LENGTH: 2000mm
3. CONNECTORS: HDB15M *1 (空9针). HDB15F*1, (满针)(黑胶芯)
4. SCREW :INCH SCREW *4(BNC螺丝)
5. CONTACTS:

HDB15M	1	2	3	6	7	8	4	5	10	11	12	13	14	64
HDB15F	1	2	3	6	7	8	4	5	10	11	12	13	14	64
	红	绿	蓝	红	绿	蓝	26AWG							
	轴	轴	轴	地	地	地								
6. MOLD: IBM四方模(内用马口铁)马口铁要压到编织线.)
7. OPEN/SHORT TEST: 100% TEST.
INSULATIONS: 2M.
8. ALL MUST BE ROHS COMPLIANT.

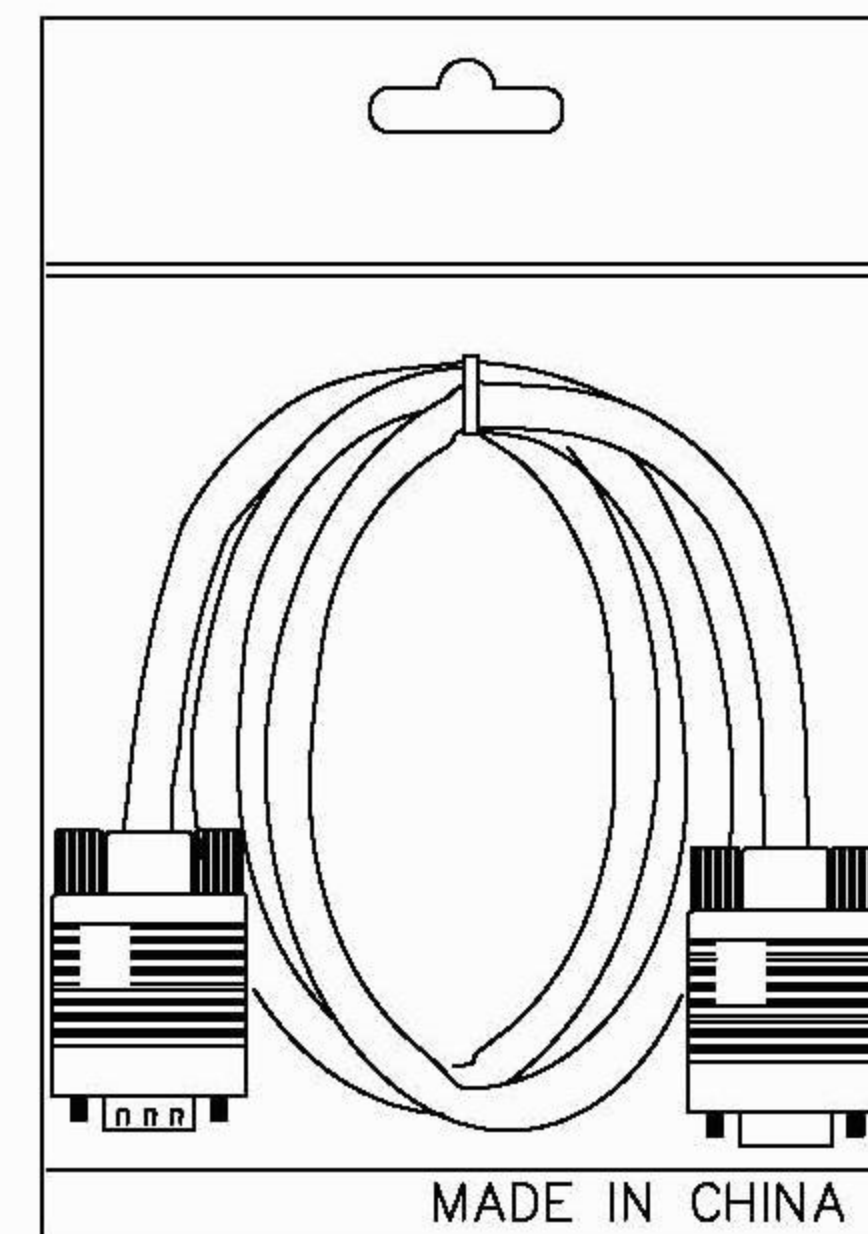

PE BAG(190*300*0.06)
+ 吊卡+条码贴纸

COMPANY	RLA		ITEM NO.	11.04.5302	NO	B3897	SCALE	NON
REVISION	DATE	DISCRIPTION	DRAWN BY				UNIT(mm)	
REV.A/0	2006.04.27	C6-2604081	DESIGNED BY				DRAWING NO.	
			APPROVAL BY					
Rotronic Co.,Ltd.								