

DO NOT SCALE DRAWING

REVISIONS				
ZONE	REV.	DESCRIPTION	DATE	APPROVED
	A	DRAWN	13-06-2013	

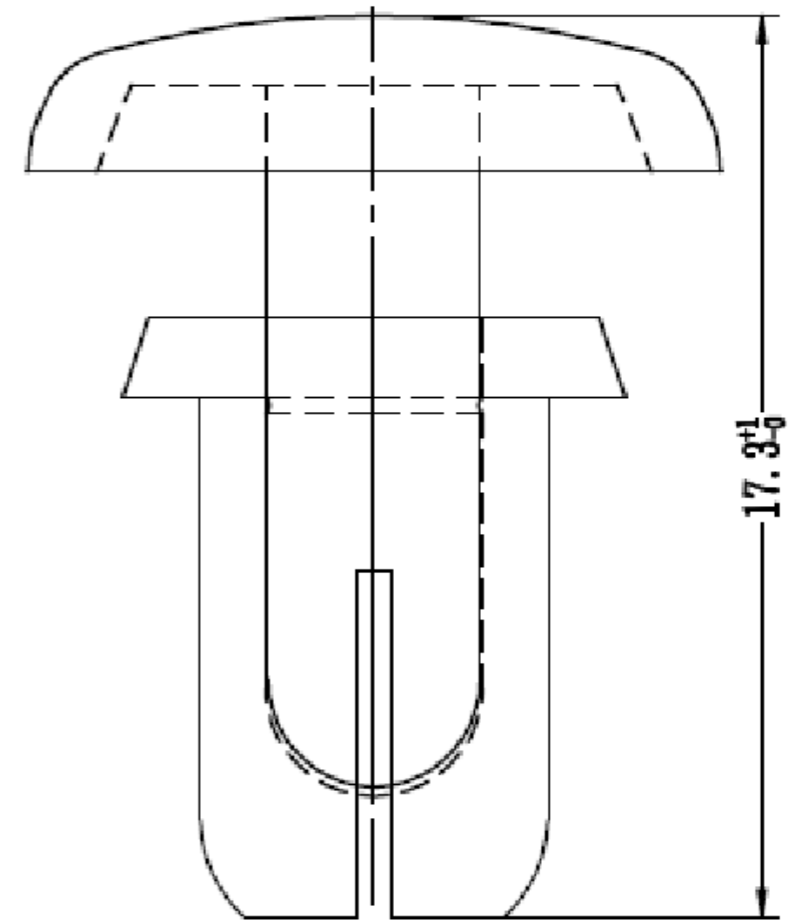
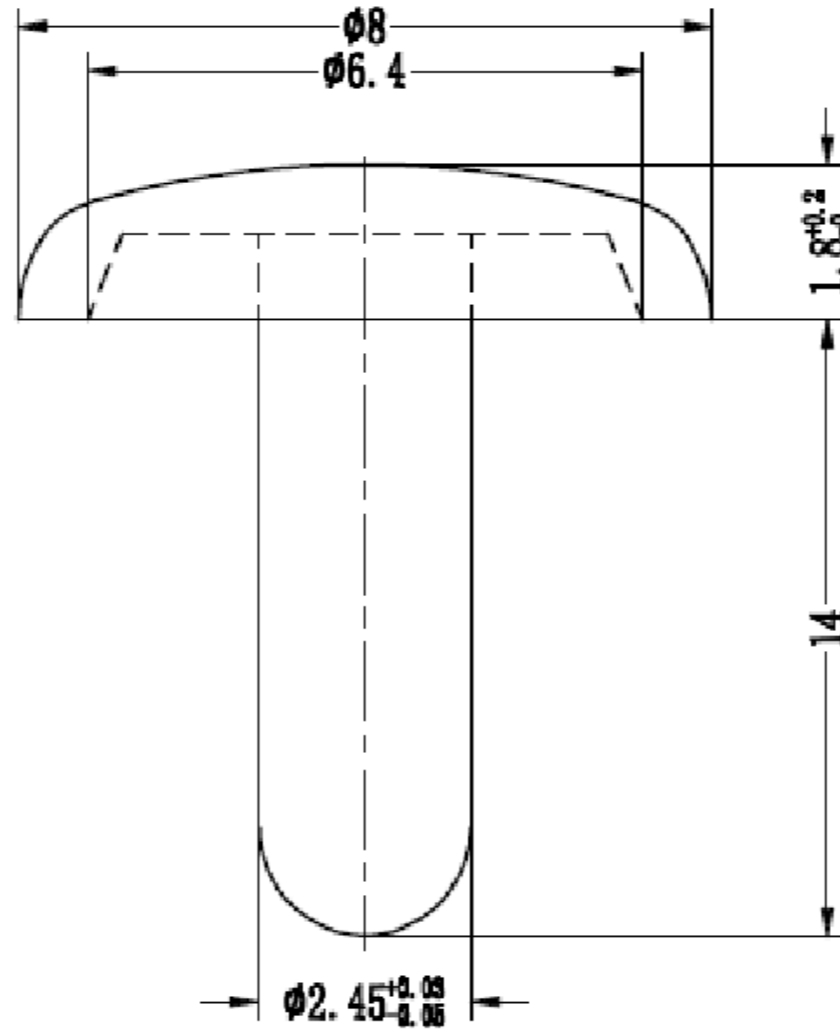
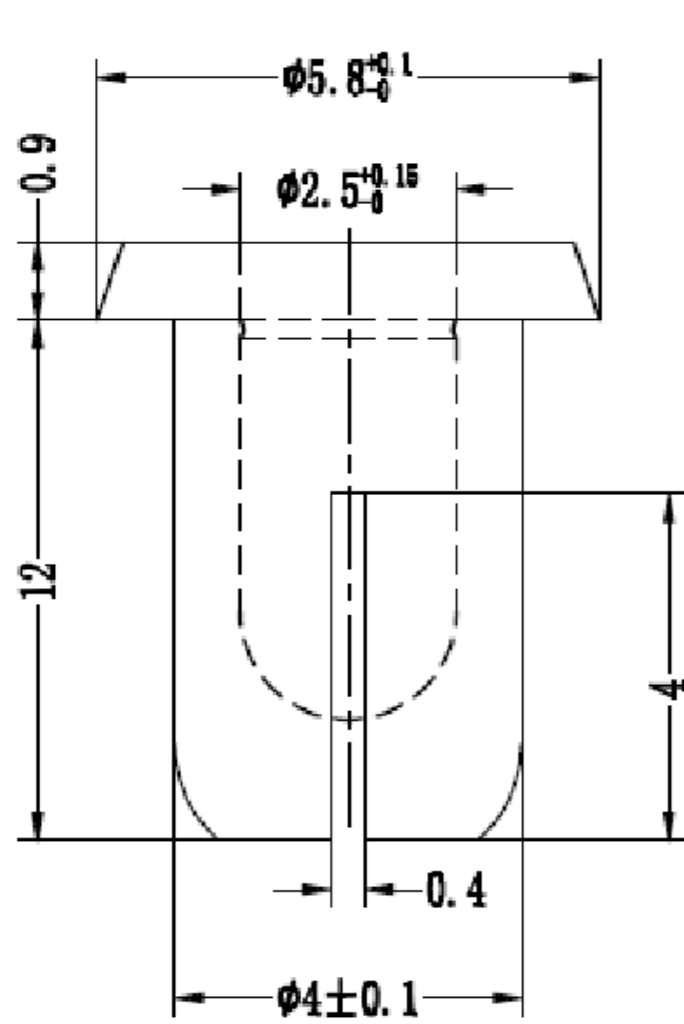

NOTES

Also available in flame retardant nylon (PA6 UL94V-0)



DESIGN RIGHT. TR FASTENINGS LTD, 2003  
 UNDER NO CIRCUMSTANCES MUST THIS  
 DRAWING BE COPIED OR DISCLOSED,  
 WITHOUT FIRST OBTAINING WRITTEN  
 AUTHORITY.

UNLESS OTHERWISE SPECIFIED:  
 DIMENSIONS ARE IN MILLIMETERS.  
 SURFACE FINISH:  
 TOLERANCES:  
 L ≤ 4 = ±0,1      4 < L ≤ 15 = ±0,2  
 15 < L ≤ 50 = ±0,3      50 < L ≤ 100 = ±0,4

	NAME	DATE
DRAWN	DANIELE MONTALI	13/06/2013
CHK'D		
APPV'D		

MATERIAL  
 PA6 UL94V-2  
 ROHS compliant

HEAT TREATMENT  
 N/A

FINISH  
 Black or White

TITLE  
 Snap Rivet

DWG NO.  
**TRSR4120**

A3