



**B8041089**  
**STAR-KNOBS 41**

Passend für Drehpotentiometer und Drehimpulsgeber mit runden Wellenenden nach DIN 41591.  
Spannzangensystem für bequeme Knopfmontage von vorn. Achsbohrung durchgehend.

**Lieferumfang**

1 Knopf (Mindestbestandteile für 1 STAR-KNOB: 1 Knopf, 1 Deckel und 1 Montage-Set)

**Technische Daten**

|           |                                |             |       |
|-----------|--------------------------------|-------------|-------|
| Material  | PA 6                           | Durchmesser | 41 mm |
| Farbe     | nero                           | Höhe        | 14 mm |
| Standards | RoHS konform,<br>REACH konform | Achsbohrung | 8 mm  |

**Kaufmännische Daten**

|                                   |  |
|-----------------------------------|--|
| Lieferumfang                      | 1 Knopf (Mindestbestandteile für 1 STAR-KNOB: 1 Knopf, 1 Deckel und 1 Montage-Set) |
| Verpackungseinheit (VE)           | 1 Stück  |
| Mindestbestellmenge               | 1 VE   |
| Gewicht/1 Stück                   | 20 g   |
| Warentarifnummer<br>(OKW Produkt) | 84879090   |
| Herstellungsland                  | Deutschland  |

**B8041089  
STAR-KNOBS 41**

Passende Systemkomponenten / Zubehör

**Einbau-Variante ohne Beleuchtung**







**Mindestbestandteile**  
1 Knopf.  
1 Deckel.  
1 Montage-Set Einbau-Variante.

| Foto | Bestell-Nr. | Artikel Version | Schutzart | Material | Farbe | Außenabmessungen |
|------|-------------|-----------------|-----------|----------|-------|------------------|
|------|-------------|-----------------|-----------|----------|-------|------------------|

**Systemkomponenten zum Komplettieren**

|   |                 |                                   |  |      |        |  |
|---|-----------------|-----------------------------------|--|------|--------|--|
|    | <b>B8641008</b> | Deckel 41                         |  | PA 6 | vulkan |  |
|    | <b>B8641009</b> | Deckel 41                         |  | PA 6 | nero   |  |
|   | <b>B8641108</b> | Deckel 41, mit Fingermulde        |  | PA 6 | vulkan |  |
|  | <b>B8641109</b> | Deckel 41, mit Fingermulde        |  | PA 6 | nero   |  |
|  | <b>B8741118</b> | Montage-Set 41,<br>Einbauvariante |  | PA 6 | vulkan |  |
|  | <b>B8741119</b> | Montage-Set 41,<br>Einbauvariante |  | PA 6 | nero   |  |

**Zubehör**

|   |                 |                       |  |                |      |  |
|---|-----------------|-----------------------|--|----------------|------|--|
|  | <b>A6207009</b> | Rundmutter M7 x 0,75  |  |                |      |  |
|  | <b>A6210009</b> | Rundmutter M10 x 0,75 |  |                |      |  |
|  | <b>A6295009</b> | Rundmutter 3/8"-32G   |  |                |      |  |
|  | <b>A6300000</b> | Steckschlüssel        |  |                |      |  |
|  | <b>B8741001</b> | Montagehilfe 41       |  | ABS (UL 94 HB) | grün |  |









**Aufbau-Variante mit LED Beleuchtung**



**Mindestbestandteile**  
 1 Knopf.  
 1 Deckel.  
 1 Montage-Set Aufbau-Variante.  
 1 LED-Beleuchtung.

| Foto | Bestell-Nr. | Artikel Version | Schutzart | Material | Farbe | Außenabmessungen |
|------|-------------|-----------------|-----------|----------|-------|------------------|
|------|-------------|-----------------|-----------|----------|-------|------------------|

**Systemkomponenten zum Komplettieren**

|   |                 |                                |  |               |         |  |
|---|-----------------|--------------------------------|--|---------------|---------|--|
|    | <b>B8641008</b> | Deckel 41                      |  | PA 6          | vulkan  |  |
|    | <b>B8641009</b> | Deckel 41                      |  | PA 6          | nero    |  |
|    | <b>B8641108</b> | Deckel 41, mit Fingermulde     |  | PA 6          | vulkan  |  |
|    | <b>B8641109</b> | Deckel 41, mit Fingermulde     |  | PA 6          | nero    |  |
|  | <b>B8741201</b> | Montage-Set 41, Aufbauvariante |  | PC (UL 94 HB) | diamant |  |
|  | <b>B8741203</b> | Montage-Set 41, Aufbauvariante |  | PC (UL 94 HB) | rubin   |  |
|  | <b>B8741205</b> | Montage-Set 41, Aufbauvariante |  | PC (UL 94 HB) | smaragd |  |
|  | <b>B8741206</b> | Montage-Set 41, Aufbauvariante |  | PC (UL 94 HB) | saphir  |  |

**Zubehör "Beleuchtung"**

|   |                 |                                 |
|---|-----------------|---------------------------------|
|  | <b>B8733000</b> | LED-Beleuchtung                 |
|  | <b>B8733002</b> | LED-Beleuchtung (RGB-Backlight) |

**Zubehör**















|   |                 |                       |
|---|-----------------|-----------------------|
|  | <b>A6207009</b> | Rundmutter M7 x 0,75  |
|  | <b>A6210009</b> | Rundmutter M10 x 0,75 |
|  | <b>A6295009</b> | Rundmutter 3/8"-32G   |
|  | <b>A6300000</b> | Steckschlüssel        |

| Foto  | Bestell-Nr.     | Artikel Version | Schutzart | Material       | Farbe | Außenabmessungen |
|---|-----------------|-----------------|-----------|----------------|-------|------------------|
|  | <b>B8741001</b> | Montagehilfe 41 |           | ABS (UL 94 HB) | grün  |                  |

**Aufbau-Variante ohne Beleuchtung**



**Mindestbestandteile**  
 1 Knopf.  
 1 Deckel.  
 1 Montage-Set Aufbau-Variante.

| Foto  | Bestell-Nr.     | Artikel Version                | Schutzart | Material       | Farbe   | Außenabmessungen |
|---|-----------------|--------------------------------|-----------|----------------|---------|------------------|
| <b>Systemkomponenten zum Komplettieren</b>  |                 |                                |           |                |         |                  |
|    | <b>B8641008</b> | Deckel 41                      |           | PA 6           | vulkan  |                  |
|    | <b>B8641009</b> | Deckel 41                      |           | PA 6           | nero    |                  |
|    | <b>B8641108</b> | Deckel 41, mit Fingermulde     |           | PA 6           | vulkan  |                  |
|    | <b>B8641109</b> | Deckel 41, mit Fingermulde     |           | PA 6           | nero    |                  |
|   | <b>B8741201</b> | Montage-Set 41, Aufbauvariante |           | PC (UL 94 HB)  | diamant |                  |
|  | <b>B8741203</b> | Montage-Set 41, Aufbauvariante |           | PC (UL 94 HB)  | rubin   |                  |
|  | <b>B8741205</b> | Montage-Set 41, Aufbauvariante |           | PC (UL 94 HB)  | smaragd |                  |
|  | <b>B8741206</b> | Montage-Set 41, Aufbauvariante |           | PC (UL 94 HB)  | saphir  |                  |
|  | <b>B8741218</b> | Montage-Set 41, Aufbauvariante |           | PA 6           | vulkan  |                  |
|  | <b>B8741219</b> | Montage-Set 41, Aufbauvariante |           | PA 6           | nero    |                  |
| <b>Zubehör</b>  |                 |                                |           |                |         |                  |
|  | <b>A6207009</b> | Rundmutter M7 x 0,75           |           |                |         |                  |
|  | <b>A6210009</b> | Rundmutter M10 x 0,75          |           |                |         |                  |
|  | <b>A6295009</b> | Rundmutter 3/8"-32G            |           |                |         |                  |
|  | <b>A6300000</b> | Steckschlüssel                 |           |                |         |                  |
|  | <b>B8741001</b> | Montagehilfe 41                |           | ABS (UL 94 HB) | grün    |                  |

### **Kundenspezifische Modifikationen**

Was benötigen Sie für Ihr persönliches Produkt? Bei Bedarf liefern wir Ihnen die Gehäuse einbaufertig mit allen notwendigen Modifikationen und Veredelungen.



Mechanische Bearbeitung



Sieb-/ Tampondruck

Technische Änderungen vorbehalten. © OKW Gehäusesysteme, Buchen/Deutschland.

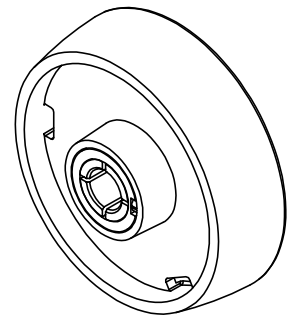
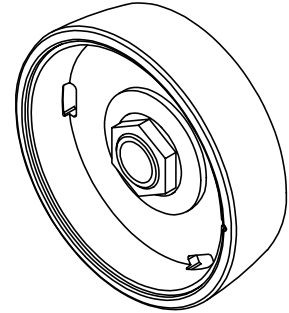
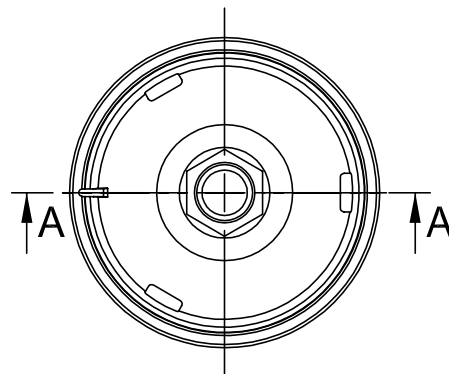
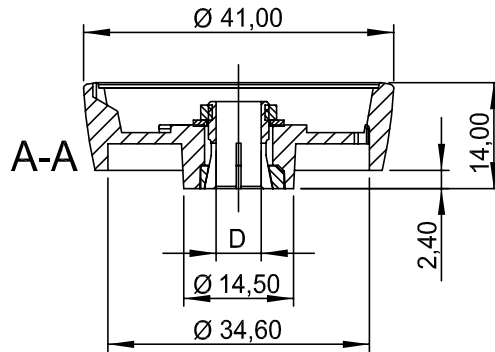

|  |      |      |
|--|------|------|
| B 80 41 068<br>B 80 41 069                               | 6 mm |      |
| B 82 41 061<br>B 82 41 063<br>B 82 41 065<br>B 82 41 066 |      |      |
| B 80 41 088<br>B 80 41 089                               |      | 8 mm |
| B 82 41 081<br>B 82 41 083<br>B 82 41 085<br>B 82 41 086 |      |      |
| <b>Part. No.</b>   |      |      |

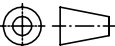
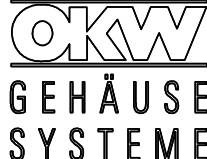
|  |                     |  |   |   |
|--|---------------------|--|---|---|
| <b>Informationskopie</b><br>wird nicht aktualisiert<br><b>Copy for Information</b><br>will not be updated  | Bearb. am: 19.03.07 | Material:  | Toleranzen:   | <br>DIN 6 Teil 2 |
|  | Ersteller: Hasselb  |  | DIN 16901 T130  |   |
| Technische Änderungen vorbehalten. Irrtümer und Druckfehler begründen keinen Anspruch auf Schadenersatz. Wichtige Einbaumaße bitte direkt mit dem aktuellen Produkt abstimmen.<br>Subject to technical modification without prior notice. Typographical and other errors do not justify any claim for damages. All dimensions should be verified using an actual moulded part.<br>Sous réserve de modifications techniques. Toute erreur ou faute d'impression ne justifie aucune demande d'indemnisation. Nous prions les clients de vérifier les dimensions des composants avec les boîtiers avant le montage. | Freigabe:           | Farbe:   | Zeichnungsart:<br>KUNDE   | Maßstab:<br><br>1:1   |
|  | Rev. Index: 2       |  |   |   |
|   | Stand: . .          | This document contains proprietary information of OKW Gehäusesysteme GmbH and is tendered subject to the conditions that the information be retained in confidence not be reproduced or copied and not be used or incorporated in any product. |   | Bearbeiter:<br>Hasselb  |
|  |                     | <b>STAR-KNOBS</b><br><b>STAR-KNOB 41, without Knurls</b><br><b>B8*410**</b>  | Für dieses Dokument behalten wir uns alle Urheberrechte vor. Es darf auch auszugsweise weder vervielfältigt noch Dritten in irgendeiner Form zugänglich gemacht werden. |   |