

Lichtschranken/Lichttaster
Baureihe W34, Reflexions-Lichtschranke

WL34-B440



Typ > [WL34-B440](#)
Artikelnr. > [1019246](#)

- Robustes Kunststoffgehäuse
- Hohe Funktionsreserve in sichtbarem Rotlicht
- M16-Verschraubung bzw. Gerätestecker um 90° drehbar
- Zeitstufen

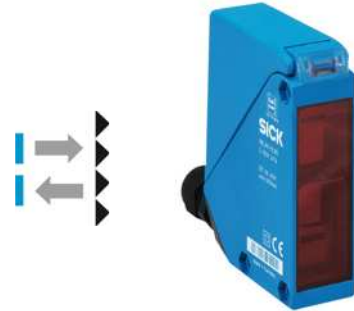

Produktmerkmale

Schaltabstand von ... bis:	0,03 ... 22 m
Bezogen auf:	Reflektor PL80A
Empfindlichkeitseinstellung:	Potentiometer
Lichtsender:	LED
Lichtart:	Rotlicht
Lichtfleckdurchmesser:	Ca. 250 mm in 15 m Entfernung

Technische Daten

Bauform:	quaderförmig
Abmessungen (B x H x T):	27 x 92 x 70 mm
Versorgungsspannung von ... bis:	DC 10 ... 30 V
Restwelligkeit:	< 5 Vss
Stromaufnahme:	≤ 50 mA
Schaltausgang:	PNP o. NPN, Q o. nicht Q
Ausgangsstrom max:	100 mA
Ansprechzeit:	≤ 500 µs
Schaltfolge:	1.000 Hz
Zeitstufe:	einstellbar: 0,5 ... 10 s
Testeingang Sender aus:	PNP o. NPN: TE nach 0 V
Alarmausgang:	Verschmutzungsmeldung VMA, PNP
Anschlussart:	Steckverbindung, M12, 4-polig
Schutzschaltungen:	Uv-Anschlüsse verpolsicher/Ausgang Q und nicht Q kurzschlussgeschützt/Störimpulsunterdrückung
Schutzart:	IP 67
Umgebungstemperatur, Betrieb von ... bis:	-40 °C ... +60 °C
Umgebungstemperatur, Lager von ... bis:	-40 °C ... +75 °C
Gewicht:	ca. 140 g
Frontscheibenheizung:	-
Polfilter:	✓
Werkstoff, Gehäuse:	ABS

Masszeichnung

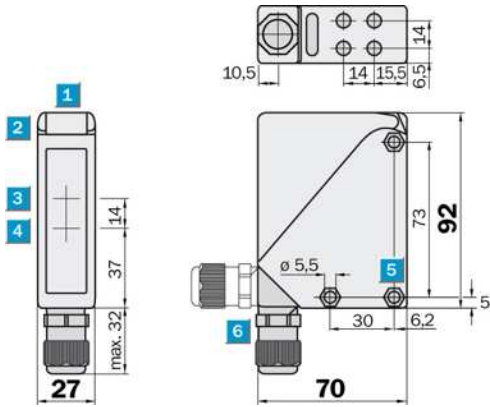

Anschlussart

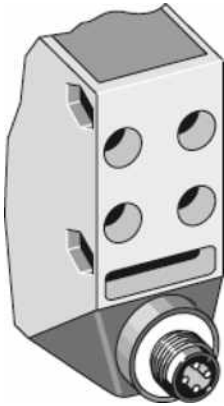

Funktionsreserve

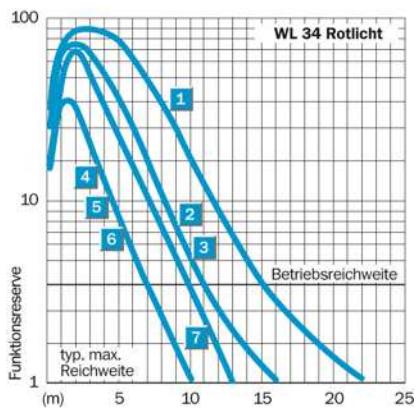

Einstell-Möglichkeiten

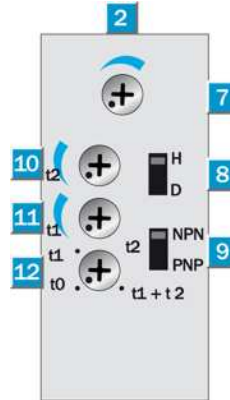

Anschluss-Schema

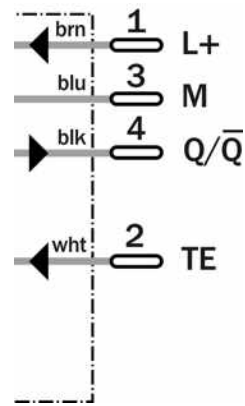

Schaltabstand-Diagramm

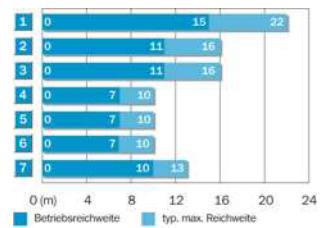

Reflektor-Typ	Betriebsreichweite
1 PL 80 A	0 ... 15 m
2 PL 50 A	0 ... 11 m
3 PL 40 A	0 ... 11 m
4 PL 30 A	0 ... 7 m
5 PL 20 A	0 ... 7 m
6 Diamond Grade (20 cm x 20 cm)	0 ... 7 m
7 C 110	0 ... 10 m

Australia

Phone +61 3 9497 4100
1800 33 48 02 – tollfree
E-Mail sales@sick.com.au

Belgium/Luxembourg

Phone +32 (0)2 466 55 66
E-Mail info@sick.be

Brasil

Phone +55 11 3215-4900
E-Mail sac@sick.com.br

Ceská Republika

Phone +420 2 57 91 18 50
E-Mail sick@sick.cz

China

Phone +852-2763 6966
E-Mail ghk@sick.com.hk

Danmark

Phone +45 45 82 64 00
E-Mail sick@sick.dk

Deutschland

Phone +49 211 5301-301
E-Mail kundenservice@sick.de

España

Phone +34 93 480 31 00
E-Mail info@sick.es

France

Phone +33 1 64 62 35 00
E-Mail info@sick.fr

Great Britain

Phone +44 (0)1727 831121
E-Mail info@sick.co.uk

India

Phone +91-22-4033 8333
E-Mail info@sick-india.com

Israel

Phone +972-4-999-0590
E-Mail info@sick-sensors.com

Italia

Phone +39 02 27 43 41
E-Mail info@sick.it

Japan

Phone +81 (0)3 3358 1341
E-Mail support@sick.jp

Nederlands

Phone +31 (0)30 229 25 44
E-Mail info@sick.nl

Norge

Phone +47 67 81 50 00
E-Mail austefjord@sick.no

Österreich

Phone +43 (0)22 36 62 28 8-0
E-Mail office@sick.at

Polska

Phone +48 22 837 40 50
E-Mail info@sick.pl

Republic of Korea

Phone +82-2 786 6321/4
E-Mail info@sickkorea.net

Republika Slovenija

Phone +386 (0)1-47 69 990
E-Mail office@sick.si

România

Phone +40 356 171 120
E-Mail office@sick.ro

Russia

Phone +7 495 775 05 34
E-Mail info@sick-automation.ru

Schweiz

Phone +41 41 619 29 39
E-Mail contact@sick.ch

Singapore

Phone +65 6744 3732
E-Mail admin@sicksgp.com.sg

Suomi

Phone +358-9-25 15 800
E-Mail sick@sick.fi

Sverige

Phone +46 10 110 10 00
E-Mail info@sick.se

Taiwan

Phone +886 2 2375-6288
E-Mail sales@sick.com.tw

Türkiye

Phone +90 216 587 74 00
E-Mail info@sick.com.tr

United Arab Emirates

Phone +971 4 8865 878
E-Mail info@sick.ae

USA/Canada/México

Phone +1(952) 941-6780
1 800-325-7425 – tollfree
E-Mail info@sickusa.com

More representatives and agencies
in all major industrial nations at
www.sick.com