



Floodlight FL

FL LED 200W NERO IP66 4K

Ultra-thin projector with modern and elegant design, suitable for civil, commercial and industrial applications. The body is made of die-cast aluminium with integrated cooling fins.

Order code 86177

EAN 8002219877642

Technical specifications

Absorbed Power	200 W
Supply voltage type	AC
Nominal voltage (AC)	230 Vac
Ambient temperature (min)	-10 °C
Ambient temperature (max)	45 °C
Insulation class	I
CCT light tone	4000 K
Photobiological risk	RG0
CRI color rendering	>80
Ballast	For constant current LED
Efficiency	100 lm/W
Frequency (max)	60 Hz
Frequency (min)	50 Hz
Glow wire strength	960 °C - 30s.
Luminaire flux	20000 lm
Luminous flux L70B50	30000 h
Voltage supply range (max)	253 V
Voltage supply range (min)	207 V

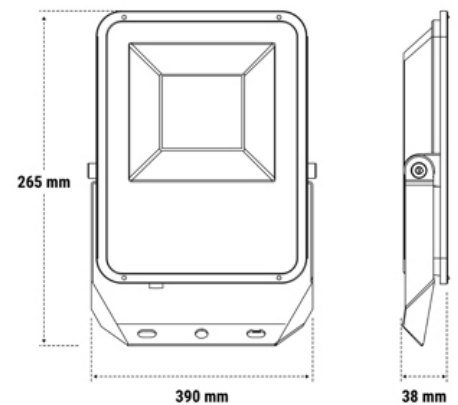

Installation and applications

Environment **Art/Culture**

Mechanical specifications

Height	38 mm
Length	265 mm
Width	380 mm
Weight	2.65 Kg
Body material	Die-cast aluminium
Colour housing	Black
Reflector material	Polycarbonate
Protection grade IP	IP66
Protection grade IK	IK07

Certifications and norms

UK SI 2021 No. 1095, EN IEC 55015:2019 + A11:2020, EN IEC 61000-3-2 :2019, EN 61547:2009, EN 62471:2008, EN IEC 60598-1:2021, EN 60598-2-1:1989, EN IEC 63000:2018, EN 62493:2010, EN 61000-3-3:2013

