

## U-Handles · with support washer

24310.0020



### Product Description

U-handles are used, for example, on machine doors, furniture doors, cabinet doors, drawers and drawer units.

These rounded U-handles are characterised by their ergonomic and stable construction and their simple and timeless design.

### Material

#### Handle

- Steel, chromium-plated

#### Support washer

- Zinc die-cast, nickel-plated

### Assembly

The supporting washer provides a good bearing surface. Suitable washers are joined in loose form.

### Drawing

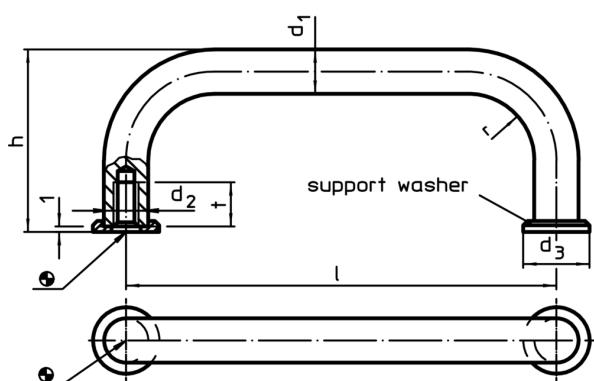

### Order information

$d_1$	$l$ $\pm 0.5$	$d_2$	Dimensions $d_3$ [mm]	$h$	$r$	$t$ min.	 [g]	Art. No.
steel								
8	64	M4	12	35	10	8	44	24310.0020

### Compliance

#### RoHS compliant

Contains lead - compliant according to exceptions 6a / 6b / 6c

#### Contains SVHC substances >0,1% w/w

Contains lead - SVHC list [REACH] as of 10.06.2022

#### Contains Proposition 65 substances



Lead can cause cancer and reproductive harm from exposure  
<https://www.P65Warnings.ca.gov/>

#### Free from Conflict Minerals

This product does not contain any substances designated as "conflict minerals" such as tantalum, tin, gold or tungsten from the Democratic Republic of Congo or adjacent countries.