

<b>Title</b>	<b><i>Reference Design Report for a 200 W 3-Phase Inverter Using BridgeSwitch™ BRD1263C and LinkSwitch™-TN2 LNK3204D in FOC Operation</i></b>
<b>Specification</b>	340 VDC Input, 200 W Continuous Three Phase Inverter Output Power, 0.67 A <sub>RMS</sub> Continuous Motor Phase Current
<b>Application</b>	High-Voltage Brushless DC (BLDC) Motor Drive
<b>Author</b>	Applications Engineering Department
<b>Document No.</b>	RDR-852
<b>Date</b>	July 27, 2020
<b>Revision</b>	1.1

**Summary and Features**

- BridgeSwitch – high-voltage half-bridge motor driver
- Integrated 600 V FREDFETs with ultra-soft, fast recovery diodes
- No heat sink
- Fully self-biased operation – simplifies auxiliary power supply but can also support external bias operation as needed
- High-side and low-side cycle-by-cycle current limit
- Two level device over-temperature protection
- High-voltage bus monitor with four undervoltage threshold and one overvoltage threshold
- System level temperature monitor
- Single wire status update communication bus
- Supports any microcontroller (MCU) for sensorless field oriented control (FOC) through the signal interface
- Instantaneous phase current output signal for each BridgeSwitch
- Fault reporting for each device through the FAULT BUS pin on the interface
- +5 V supply ready through the interface

**PATENT INFORMATION**

The products and applications illustrated herein (including transformer construction and circuits external to the products) may be covered by one or more U.S. and foreign patents, or potentially by pending U.S. and foreign patent applications assigned to Power Integrations. A complete list of Power Integrations' patents may be found at [www.power.com](http://www.power.com). Power Integrations grants its customers a license under certain patent rights as set forth at <https://www.power.com/company/intellectual-property-licensing/>.



## Table of Contents

1	Introduction .....	5
2	Inverter Specification .....	7
3	Schematic .....	8
4	Circuit Description.....	12
4.1	Three-Phase BridgeSwitch Inverter .....	12
4.2	BridgeSwitch Bias Supply .....	12
4.3	PWM Input.....	12
4.4	Cycle-by-Cycle Current Limit.....	13
4.5	System Undervoltage (UV) and Overvoltage (OV) Protection .....	13
4.6	System Level Temperature and Monitoring.....	13
4.7	Fault Bus.....	13
4.8	Device ID .....	13
4.9	Microcontroller (MCU) Interface.....	13
4.10	External Supply .....	14
4.11	Three-Phase Motor Interface.....	14
4.12	Auxiliary Power Supply Circuit.....	14
4.13	+5 V Linear Regulator.....	14
4.14	Current Sense Amplifier .....	14
5	Printed Circuit Board Layout .....	15
6	Bill of Materials .....	17
7	Performance Data.....	18
7.1	Start-Up Operation .....	18
7.1.1	BPL and BPH Start-Up Waveforms .....	18
7.1.2	Motor Start-Up Waveforms.....	19
7.2	Steady-State Operation .....	20
7.2.1	Phase Voltages (Drain to Source) During Steady-State .....	20
7.2.2	High-Side Drain to Source Voltage Slew Rate.....	22
7.2.3	Phase Currents During Steady-State .....	23
7.2.4	INL and /INH Signals .....	24
7.2.5	BPL and BPH during Steady-State.....	25
7.3	Thermal Performance.....	26
7.3.1	30 W Loading Condition (105 mA Average Motor Phase Current) .....	27
7.3.2	100 W Loading Condition (340 mA Average Motor Phase Current) .....	27
7.3.3	200 W Loading Condition (670 mA Average Motor Phase Current) .....	28
7.3.4	Thermal Scan Summary Tables .....	28
7.3.4.1	Self Supply Mode.....	28
7.3.4.2	External Supply Mode.....	28
7.4	No-Load Input Power Consumption.....	29
7.5	Efficiency .....	30
7.5.1	Efficiency Table at Self Supply Mode .....	31
7.5.2	Efficiency Table at External Supply Mode .....	31
7.6	Device and System Level Protection / Monitoring .....	32
7.6.1	Overcurrent Protection (OCP) .....	32
7.6.2	Thermal Warning.....	33



7.6.3	Thermal Shutdown .....	34
7.6.4	Undervoltage (UV).....	35
7.6.5	Overvoltage (OV) .....	36
7.6.6	System Thermal Fault .....	37
7.7	Abnormal Motor Operation Test.....	38
7.7.1	Operation Under Stalled (Motor) Conditions .....	38
7.7.2	Operation with One Motor Phase / Winding Disconnected.....	39
7.7.3	Running Overload Test .....	41
8	Appendix .....	42
8.1	Board Quick Reference.....	42
8.1.1	The Microcontroller (MCU) Interface Contains the Following Pins / Signals ..	42
8.1.2	J4 Connector Pin Designation.....	43
8.1.3	J5 Connector Pin Designation.....	43
8.2	Recommended Start-up Sequence .....	44
8.3	Status Word Encoding.....	45
8.4	Suggested Microcontroller Action/Decision To BridgeSwitch Fault Conditions ..	46
8.5	Inverter Output Power Measurement .....	47
8.6	Current Capability vs. Ambient Temperature .....	48
8.7	Efficiency Curve at Different Switching Frequencies .....	49
8.8	Test Bench Set-up .....	50
9	Revision History.....	51

**Important Note:**

During operation, the reference design board is subject to hazards including high voltages, rotating parts, bare wires, and hot surfaces. Energized DC bus capacitors require time to discharge after DC input disconnection.

All testing should use an isolation transformer to provide the DC input to the board.



## 1 Introduction

This document describes a 200 W, 97% efficient, 3-phase inverter for high-voltage brushless DC (BLDC) motor application using three BridgeSwitch BRD1263C devices. The design shows the device performance, internal level monitoring, system level monitoring, and fault protection facilitated by the high level of integration of the BridgeSwitch half-bridge motor driver IC. A high-voltage, low component count buck converter employing a LinkSwitch-TN2 LNK3204D device supplies the current sense amplifier and optionally provides external bias for BridgeSwitch.

In addition, this document also contains the inverter specification, schematic, bill of materials, printed circuit board (PCB) layout, performance data, and test set-up. The provided waveforms along with the design performance are based on a sensorless field oriented control (FOC) method.

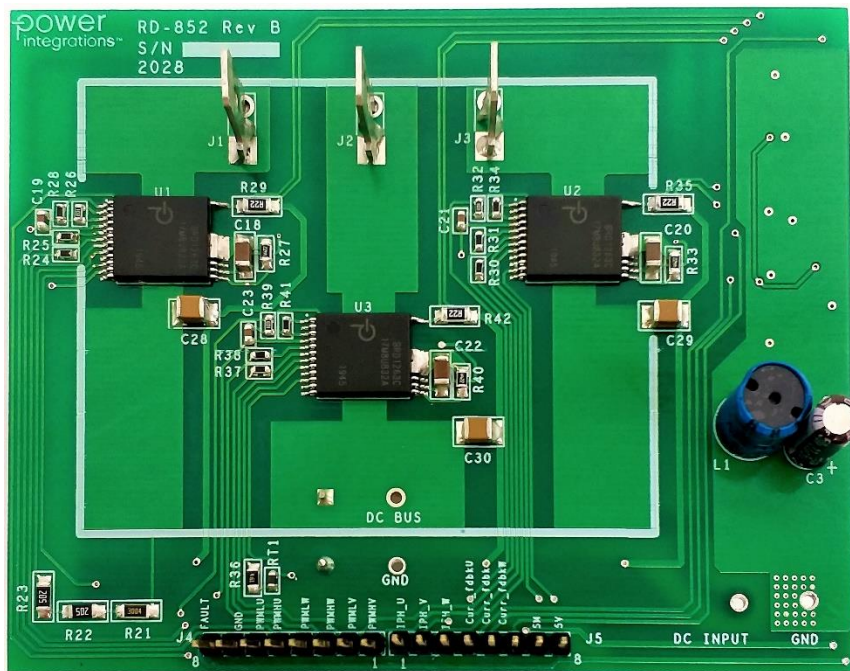

**Figure 1** – Populated Circuit Board Top View.

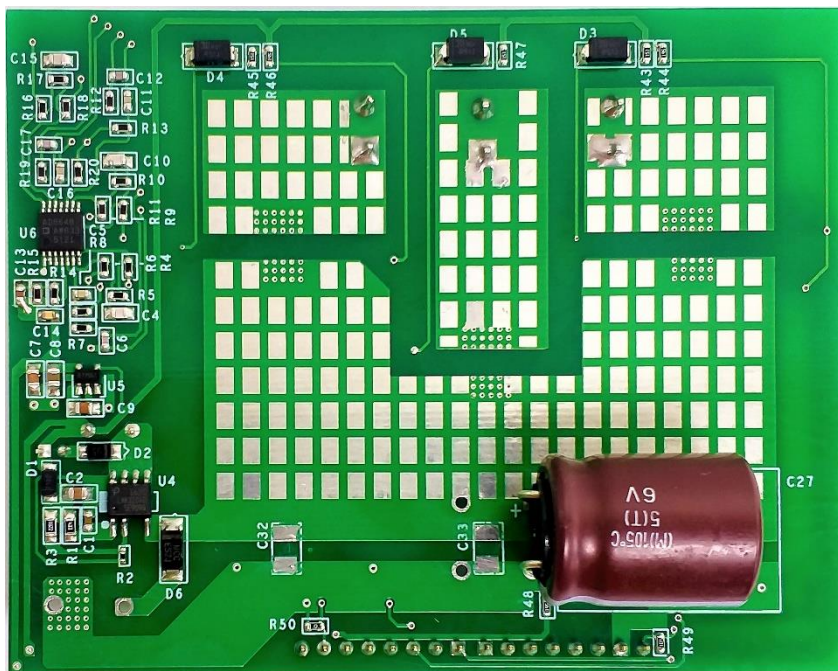

Figure 2 – Populated Circuit Board Bottom View.

## 2 Inverter Specification

The table below provides the electrical specification of the 3-phase inverter design. The result section provides actual performance data.

Description	Symbol	Min	Typ	Max	Unit	Comment
<b>Input</b>						
Voltage	$V_{IN}$	270	340	365	V	2-wire DC Input.
Current	$I_{IN}$		0.6		$A_{RMS}$	RMS.
Power	$P_{IN}$		206		W	At Efficiency = 97%.
<b>Output</b>						
Power	$P_{OUT}$		200		W	Inverter Output Power.
Motor Phase Current	$I_{MOT(RMS)}$		0.67		$A_{RMS}$	Continuous RMS per Phase.
Inverter Peak Output Current	$I_{INT(PK)}$		2.25		A	Inverter Peak Current.
PWM Carrier Frequency <sup>1</sup>	$f_{PWM}$		10	16	kHz	3-Phase FOC Modulation.
Efficiency	$\eta$		97		%	Self-Supplied Operation.
Output Speed	$\omega$		5000		RPM	Motor Speed at 200 W Inverter Output.
<b>Environmental</b>						
Ambient Temperature	$T_{AMB}$	-20	27	65	°C	Free Convection.
Device Case Temperature	$T_{PACKAGE}$		75	113	°C	0.67 $A_{RMS}$ Phase Current in Self-Supplied Operation.
<b>System Level Monitoring</b>						
DC Bus Sensing						
OV Threshold	$V_{OV}$		422		V	Reported through Status Communication Bus (FAULT Pin).
1 <sup>st</sup> UV Threshold	$V_{UV100}$		247		V	
2 <sup>nd</sup> UV Threshold	$V_{UV85}$		212		V	
3 <sup>rd</sup> UV Threshold	$V_{UV60}$		177		V	
4 <sup>th</sup> UV Threshold	$V_{UV55}$		142		V	
Over Current Protection <sup>2</sup>	$I_{OCP}$		2.25		$A_{PK}$	At XL/XH = 44.2 k $\Omega$
System Warning Temperature <sup>3</sup>	$T_{SYS}$		90		°C	
Notes: 1. 20 kHz is the maximum recommended PWM frequency with self-supply or with external supply. 2. Can be manually configured depending on the value of XL/XH. For BRD1263C, the maximum current protection level is 2.25 A at XL/XH=44.2 k $\Omega$ . 3. Sensed through an external thermistor, temperature threshold depends on chosen NTC and its location, requires verification in final application.						
<b>Table 1 – Inverter Specification.</b>						

### 3 Schematic

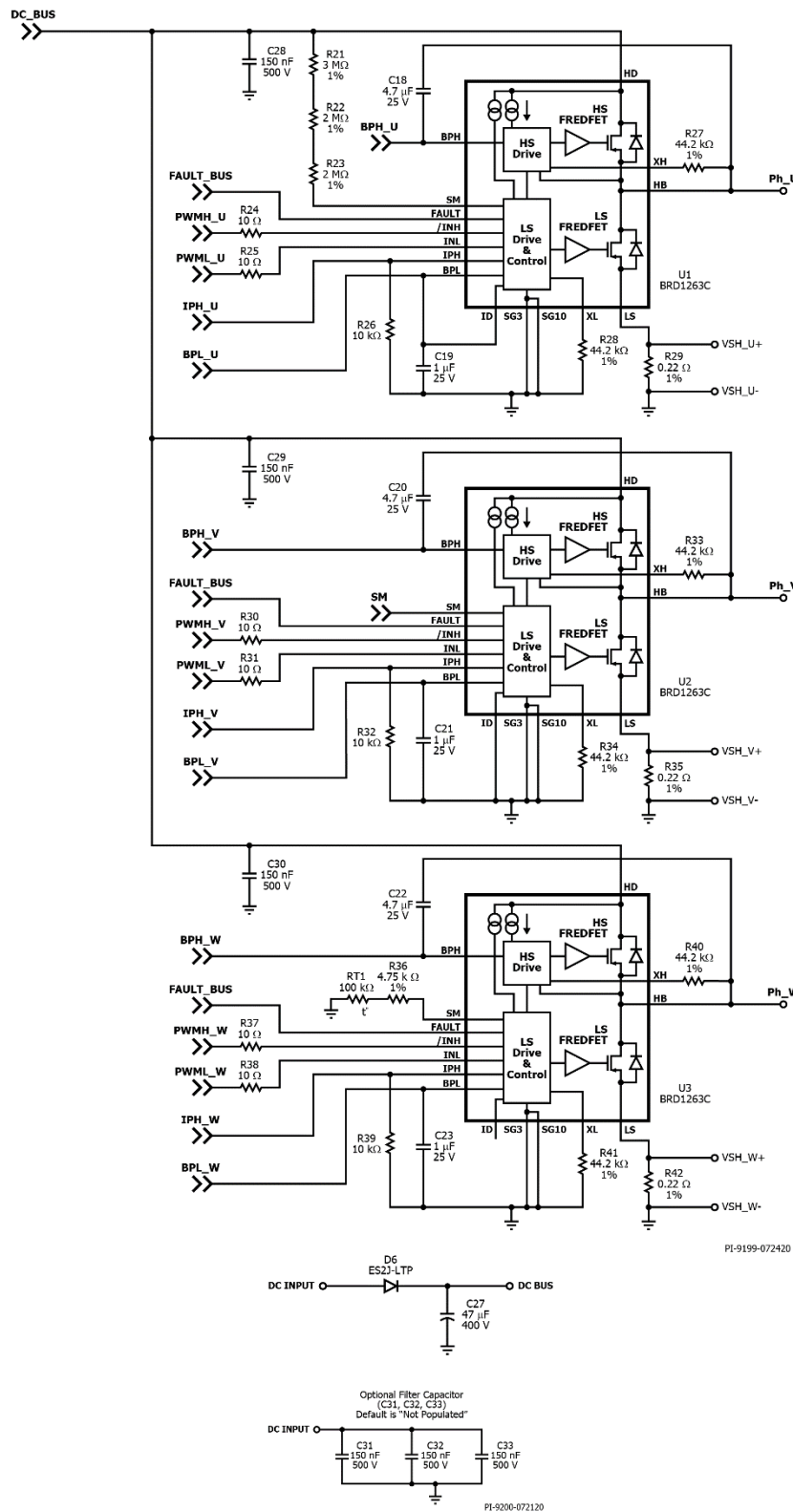

Figure 3 – BridgeSwitch 3-Phase Inverter Circuit Schematic.





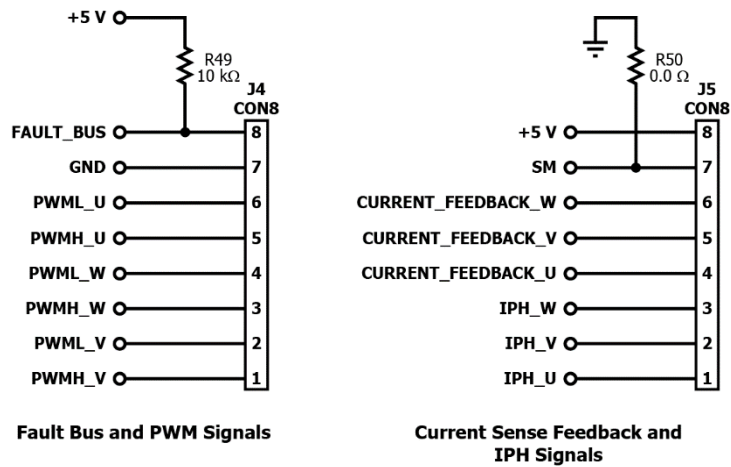

Figure 4 – Microcontroller Interface Schematic.

PI-9023-100219

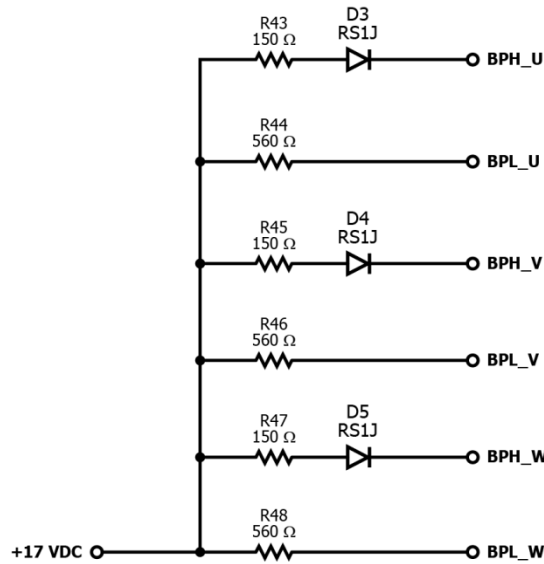
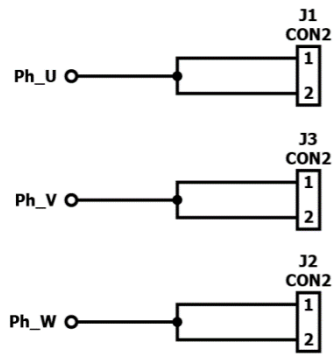

Figure 5 – External Supply Schematic.

PI-9024-100219





PI-9025-100219

Figure 6 –Three-Phase Motor Interface Schematic.

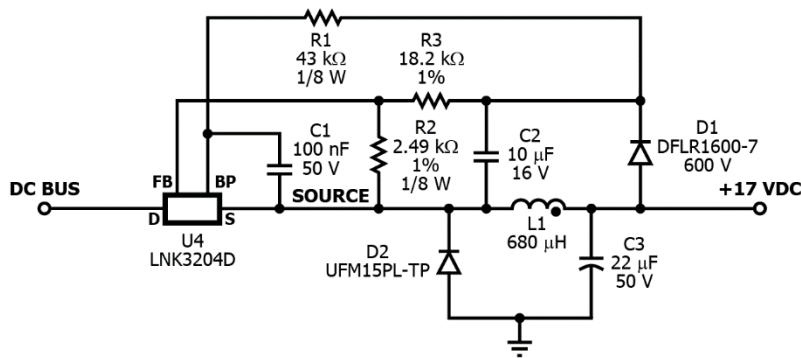

PI-9026-020620

Figure 7 – Auxiliary Schematic.

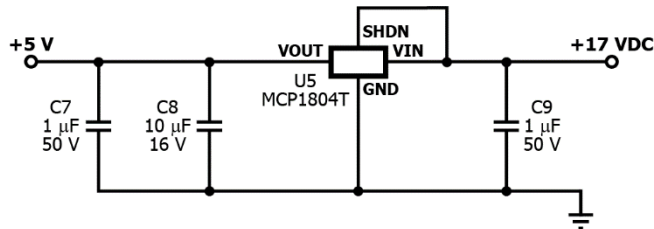

PI-9027-100219

Figure 8 – 5 V Linear Regulator Schematic.

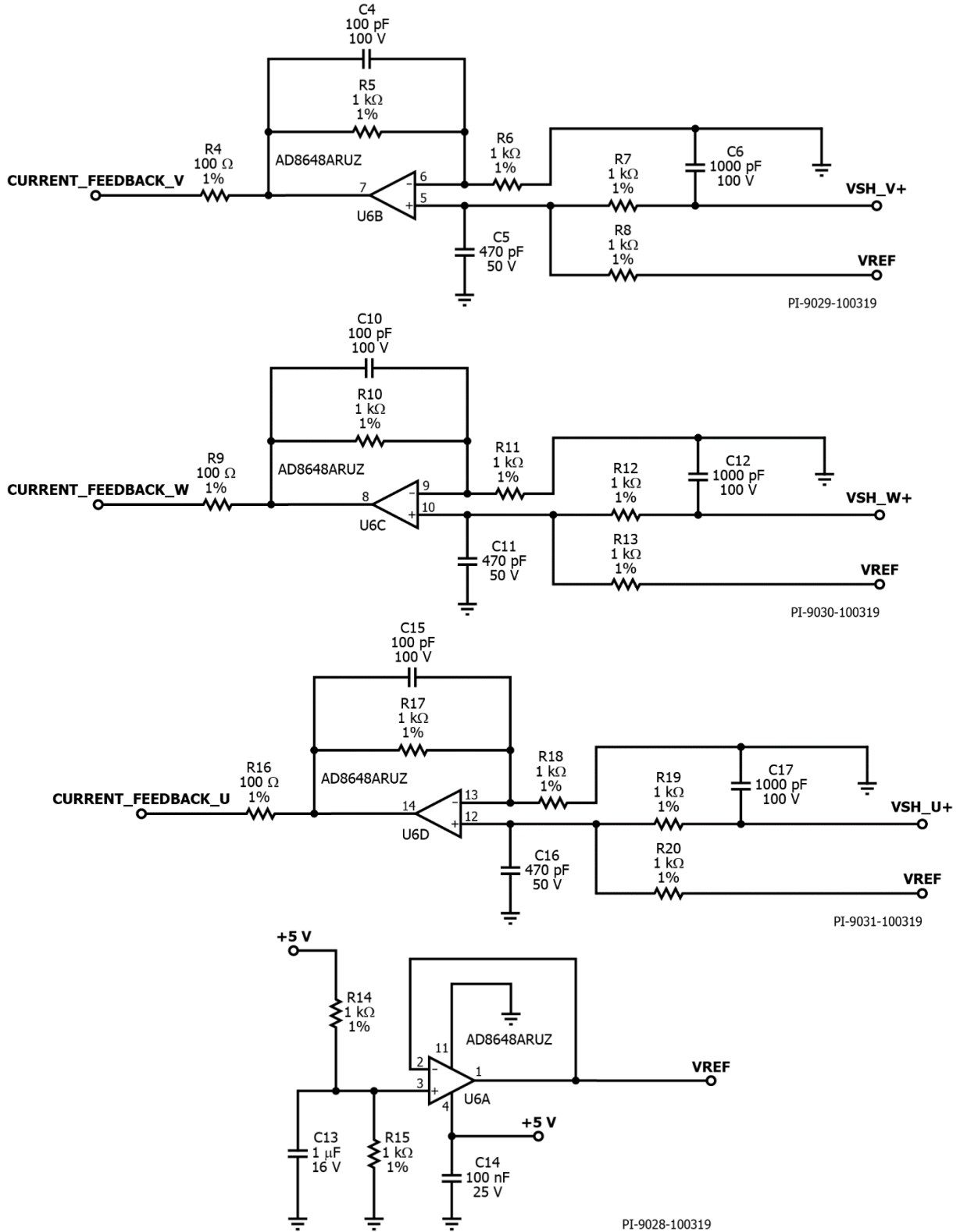

**Figure 9** – Current Sense Amplifier Circuit Schematic.



## 4 Circuit Description

The overall schematic shows a 3-phase inverter utilizing three BridgeSwitch BRD1263C devices. The circuit design drives a high-voltage, 3-phase, brushless DC (BLDC) motor utilizing field oriented control (FOC) for controlling the motor. The BridgeSwitch IC combines two 600 V, N-channel power FREDFETs with its corresponding gate drivers into a low profile surface mount package. The BridgeSwitch power FREDFET features an ultra-soft, fast recovery diode ideally suited for inverter drives. Both drivers are fully self-supplied eliminating the need for the system power supply to provide gate drive power.

A LinkSwitch-TN2 LNK3204D device in a high-voltage buck converter configuration provides an optional +17 V supply for the BridgeSwitch IC (external bias) and input DC voltage for the +5 V linear regulator that supplies the current sense amplifier circuit.

In addition, the BridgeSwitch IC incorporates internal fault protection and system level monitoring. Internal fault protection includes cycle-by-cycle current limit for both FREDFETs and a two level thermal overload protection. On the other hand, system level monitoring includes high-voltage DC bus sensing with multi-level undervoltage thresholds and one overvoltage threshold. The BridgeSwitch IC can also be configured using external sensors such as a thermistor for system temperature monitoring. A single wire open drain bus communicates all detected fault or change of status to the system microcontroller.

### 4.1 *Three-Phase BridgeSwitch Inverter*

The three BridgeSwitch devices U1, U2, and U3 form the 3-phase inverter. The output of the inverter connects to the 3-phase BLDC motor through connectors J1, J2, and J3.

### 4.2 *BridgeSwitch Bias Supply*

Capacitors C19, C21, and C23 provide self-supply decoupling for the integrated low-side controller and gate driver. An internal high-voltage current source recharges such capacitors as soon as the voltage level starts to dip. On the other hand, capacitors C18, C20, and C22 provide self-supply decoupling for the integrated high-side controller and gate driver. Internal high-voltage current sources recharge these capacitors whenever the half-bridge point of the respective device drops to the low-side source voltage level (i.e. the low-side FREDFET turns on).

### 4.3 *PWM Input*

Input PWM signals PWML\_U, PWMH\_U, PWML\_V, PWMH\_V, PWML\_W, PWMH\_W, control the switching states of the integrated high-side and low-side power FREDFETs. The system microcontroller provides the required PWM signal and desired switching frequency.



#### 4.4 ***Cycle-by-Cycle Current Limit***

Resistors R28, R34, R41, R27, R33, and R40 set the cycle-by-cycle current limit level for the integrated low side and high-side power FREDFETs. A selected value of 44.2 k $\Omega$  set the current limit to 100% of the default level or 2.25 A<sub>PK</sub>.

#### 4.5 ***System Undervoltage (UV) and Overvoltage (OV) Protection***

BridgeSwitch U1 monitors the DC bus voltage through resistors R21 (3 M $\Omega$ ), R22 (2 M $\Omega$ ), and R23 (2 M $\Omega$ ). The combined resistance of 7 M $\Omega$  sets the undervoltage thresholds to 247 V, 212 V, 177 V, and 142 V. The bus overvoltage threshold is at 422 V. The FAULT pin reports any detected bus voltage fault condition.

#### 4.6 ***System Level Temperature and Monitoring***

The BridgeSwitch IC (U3) monitors the system temperature through thermistor RT1 connected to the SM pin. Resistor R36 tunes the threshold for a system level fault of 90 °C. The device reports a detected status change of the externally set system level temperature through the FAULT pin.

#### 4.7 ***Fault Bus***

The BridgeSwitch devices (U1, U2, and U3) report any detected internal and system status change through pin 8 of connector J4. The system microcontroller can take action in accordance to the status update reported by the device. Such action could be for instance inverter shutdown, latch, restart, warning, etc.

#### 4.8 ***Device ID***

Each BRD1263C assigns itself a unique device ID through the connection of pin 11 (ID pin). The pin can be floating, connected to the SG pin, or connected to the BPL pin. The device ID allows the specific device flagging a fault to communicate its physical location to the system microcontroller.

#### 4.9 ***Microcontroller (MCU) Interface***

Connectors J4 and J5 serves as an interface between the system microcontroller and the BridgeSwitch three phase inverter which contains the following signals:

- **FAULT\_BUS** – Pin dedicated for fault reporting of all BridgeSwitch devices.
- **GND** – Common ground interface between the microcontroller and the inverter board.
- **PWMH\_U, PWML\_U, PWMH\_V, PWML\_V, PWMH\_W, and PWML\_W** – PWM input signal interface from the system microcontroller to the BridgeSwitch device.
- **+5 V** – Voltage supply pin for microcontroller as needed.
- **SM** – Configurable system monitoring pin for the BridgeSwitch IC (U2).
- **Curr\_fdbkU, Curr\_fdbkV, Curr\_fdbkW** – Current feedback information needed by the microcontroller (MCU). This signal directly comes from the inverter current sense resistor passing through the current sense amplifier circuit.

- **IPH\_U, IPH\_V, IPH\_W** – Instantaneous phase current information of the low-side power FREDFET drain to source current of each BridgeSwitch device coming from the IPH pin.

#### 4.10 **External Supply**

Components R43, R44, R45, R46, R47, R48 and diodes D3, D4, and D5 are responsible for providing external supply to the BridgeSwitch BPL/BPH pin through device U4. External supply operation is optional for applications that require lower inverter no-load input power or operate at elevated ambient temperatures. Otherwise, these resistors and diode components can be depopulated. If depopulated, BPL/BPH supply will be drawn internally through the BridgeSwitch device (self supply).

#### 4.11 **Three-Phase Motor Interface**

Connectors J1, J2, and J3 are mechanical connectors that directly connect the BridgeSwitch 3-phase inverter to the BLDC motor.

#### 4.12 **Auxiliary Power Supply Circuit**

Device U4 (LNK3204D) is a high-side buck switcher IC responsible for providing optional +17 V supply for BPL/BPH (external bias) and +5 V linear regulator. It directly steps down the high input DC voltage to the desired low output voltage. For more information about LNK3204D, please refer to the data sheet through the following link:

<https://ac-dc.power.com/design-support/product-documents/data-sheets/linkswitch-tn2-data-sheet/>

#### 4.13 **+5 V Linear Regulator**

Device U5 is a +5 V linear regulator that provides DC supply to the current sense amplifier circuit. It can also be used to supply an external microcontroller through pin 8 of connector J5.

#### 4.14 **Current Sense Amplifier**

Components U6B, U6C, and U6D are current sense amplifiers which receive data from sense resistors R29, R35, and R42. The current information from these sense resistors are being offset to 2.5 VDC level in the current sense op-amp output pins. The U6A circuit provides the 2.5 VDC offset reference voltage. The current information from the outputs of U6B, U6C, and U6D are sent to the microcontroller (MCU) which modulates the PWM input to the BridgeSwitch inverter maintaining desired power and RPM.

**Note:** U6A, U6B, U6C, and U6D are op-amps in one IC package (Quad op-amp, U6)



## 5 Printed Circuit Board Layout

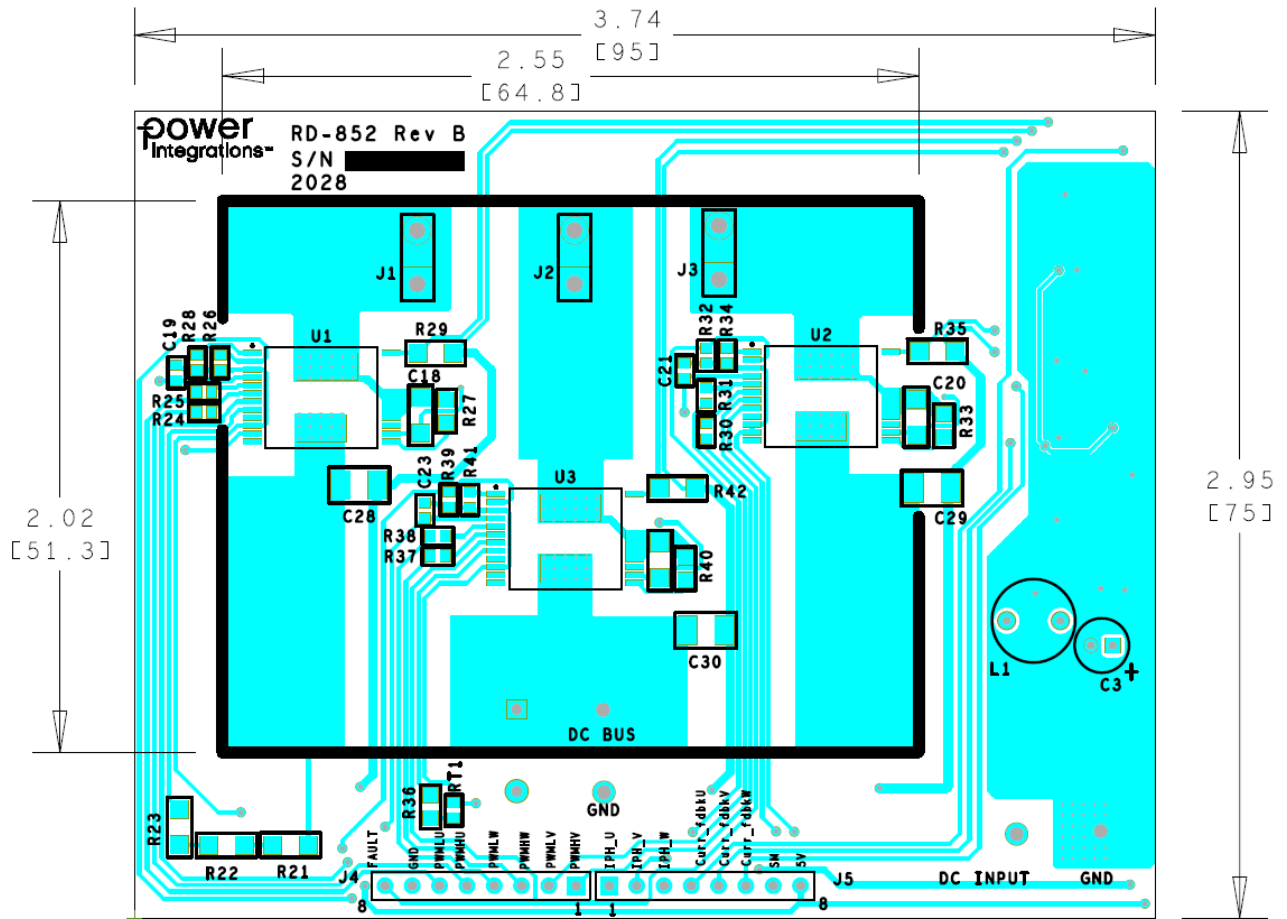
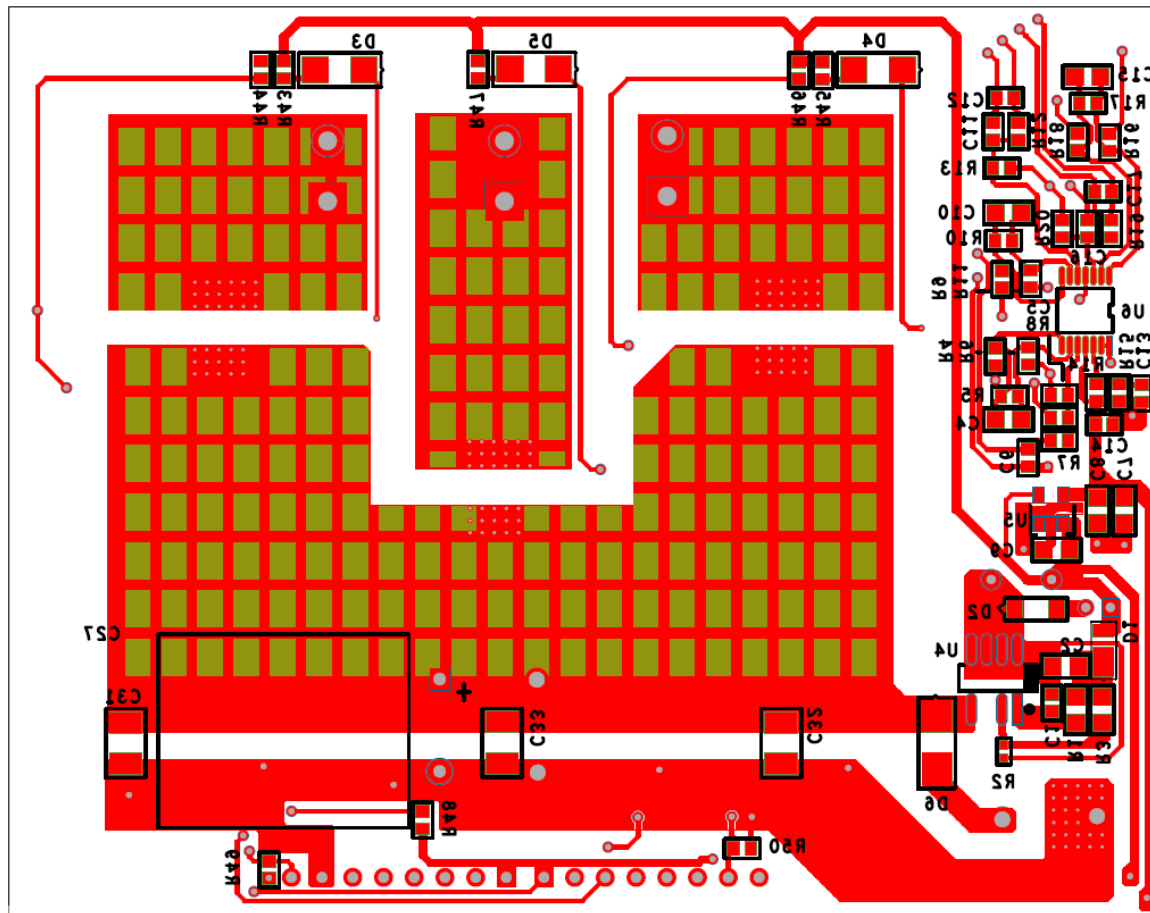

Figure 10 – Printed Circuit Board Layout Top View.

**Note:**

1. The overall PCB size dimension is 95mm x 75mm (L x W).
2. The inverter PCB area/dimension is 64.8mm x 51.3mm (L x W) – in black rectangle.





**Figure 11** – Printed Circuit Board Layout Bottom View.

**Note:**

1. The overall PCB size dimension is 95mm x 75mm (L x W).
2. The inverter PCB area/dimension is 64.8mm x 51.3mm (L x W).



## 6 Bill of Materials

Item	Qty	Ref Des	Description	Mfg Part Number	Mfg
1	1	C1	100 nF, ±10%, 50 V, Ceramic, X7R,0603	CGA3E2X7R1H104K080AA	TDK
2	2	C2,C8	10 µF, ±10%, 16V, X7R, Ceramic, SMT, MLCC 0805	CL21B106K0QNNNE	Samsung
3	1	C3	22 µF, 50 V, Electrolytic, (5 x 11)	UPW1H220MDD	Nichicon
4	3	C4,C10,C15	100 pF, 100 V, Ceramic, COG, 0805	C0805C101J1GACTU	Kemet
5	3	C5,C11,C16	470 pF 50 V, Ceramic, COG/NP0, 0603	VJ0603A471JXAAC	Vishay
6	3	C6,C12,C17	1000 pF, 100 V, Ceramic, NP0, 0603	C1608C0G2A102J	TDK
7	2	C7,C9	1 µF, 50 V, Ceramic, X5R, 0805	08055D105KAT2A	AVX
8	1	C13	1 µF 16 V, Ceramic, X7R,0603	CL10B105K08VPNC	Samsung
9	1	C14	100 nF, 25 V, Ceramic, X7R, 0603	VJ0603Y104KXXAC	Vishay
10	3	C18,C20,C22	4.7 µF, ±10%, 25 V, Ceramic, X7R, 1206	GCM31CR71E475KA55L	Murata
11	3	C19,C21,C23	1 µF, ±10%, 25 V, Ceramic, X7R, 0603	CGA3E1X7R1E105K080AE	TDK
12	1	C27	47 µF, 400 V, Electrolytic, (16 x 20)	EKXJ401ELL470ML20S	United Chemi-Con
13	6	C28, C29, C30, C31, C32, C33	150 nF, 500 V, Ceramic, X7R, 1210	C1210V154KCRCTU	Kemet
14	1	D1	600 V, 1 A, Rectifier, Glass Passivated, POWERDI123	DFLR1600-7	Diodes, Inc.
15	1	D2	600 V, 1 A, Ultrafast Recovery, 75 ns, SOD-123	UFM15PL-TP	Micro Commercial
16	3	D3,D4,D5	600 V, 1 A, Fast Recovery, 250 ns, SMA	RS1J-13-F	Diodes, Inc.
17	1	D6	600 V, 2 A, Super Fast, 35 ns, DO-214AC, SMA	ES2J-LTP	Micro Commercial
18	3	J1,J2,J3	CONN QC TAB 0.250 SOLDER	1287-ST	KeyStone
19	2	J4,J5	8 Position (1 x 8) header, 0.1 pitch, Vertical, Au	P9101-08-D32-1	Protectron
20	1	L1	680 µH, 0.36 A	SBC3-681-361	SUNX
21	1	R1	RES, 43 kΩ, 5%, 1/8 W, Thick Film, 0805	ERJ-6GEYJ433V	Panasonic
22	1	R2	RES, 2.49 kΩ, 1%, 1/10 W, Thick Film, 0402	ERJ-2RKF2491X	Panasonic
23	1	R3	RES, 18.2 kΩ, 1%, 1/8 W, Thick Film, 0805	ERJ-6ENF1822V	Panasonic
24	3	R4,R9,R16	RES, 100 Ω, 1%, 1/16 W, Thick Film, 0603	ERJ-3EKF1000V	Panasonic
25	14	R5, R6, R7, R8, R10, R11, R12, R13, R14, R15, R17, R18, R19, R20	RES, 1 kΩ, 1%, 1/16 W, Thick Film, 0603	ERJ-3EKF1001V	Panasonic
26	1	R21	RES, 3 MΩ, 1%, 1/4 W, Thick Film, 1206	KTR18EZPF3004	Rohm Semi
27	2	R22,R23	RES, 2.00 MΩ, 1%, 1/4 W, Thick Film, 1206	ERJ-8ENF2004V	Panasonic
28	6	R24, R25, R30, R31, R37, R38	RES, 10 Ω, 5%, 1/10 W, Thick Film, 0603	ERJ-3GEYJ100V	Panasonic
29	4	R26, R32, R39, R49	RES, 10 kΩ, 5%, 1/10 W, Automotive, AEC-Q200, Thick Film, 0603	ERJ-3GEYJ103V	Panasonic
30	3	R27,R33,R40	RES, 44.2 kΩ, 1%, 1/8 W, Thick Film, 0805	ERJ-6ENF4422V	Panasonic
31	3	R28,R34,R41	RES, 44.2 kΩ, 1%, 1/16 W, Thick Film, 0603	ERJ-3EKF4422V	Panasonic
32	3	R29,R35,R42	RES, 0.22 R, 1%, 1/4 W, Thick Film, 1206	ERJ-8RQFR22V	Panasonic
33	1	R36	RES, 4.75 kΩ, 1%, 1/8 W, Thick Film, 0805	ERJ-6ENF4751V	Panasonic
34	3	R43,R45,R47	RES, 150 Ω, 5%, 1/10 W, Thick Film, 0603	ERJ-3GEYJ151V	Panasonic
35	3	R44,R46,R48	RES, 560 Ω, 5%, 1/10 W, Thick Film, 0603	ERJ-3GEYJ561V	Panasonic
36	1	R50	RES, 0 Ω, 5%, 1/10 W, Thick Film, 0603	ERJ-3GEY0R00V	Panasonic
37	1	RT1	NTC Thermistor, 100 kΩ, 5%, 0603	ERT-J1VS104JA	Panasonic
38	3	U1,U2,U3	BridgeSwitch, Max. BLDC Motor Current 3A (DC)	BRD1263C	Power Integrations
39	1	U4	LinkSwitch-TN2, SO-8C	LNK3204D	Power Integrations
40	1	U5	IC, REG, LDO, 5.0 V, 0.15 A, 28 Vin max, SOT23-5, SC-74A, SOT-753	MCP1804T-5002I/OT	MicroChip
41	1	U6	IC, GP OPamp, Quad, R2R, 14-TSSOP	AD8648ARUZ-REEL	Analog Device



## 7 Performance Data

This section presents waveform plots and performance data of the BridgeSwitch inverter. The high-voltage (VBUS) level is 340 VDC unless stated otherwise. Light load measurements describe the inverter operating with no mechanical brake load applied to the motor. Full load operation describes the inverter operating at 200 W output power (refer to Appendix for the details on the method used to measure the output power of a 3-phase inverter). All measurements were performed at 10 kHz PWM frequency, room ambient temperature, and three-phase field oriented control (3-phase FOC) type of modulation.

### 7.1 Start-Up Operation

#### 7.1.1 BPL and BPH Start-Up Waveforms

The waveforms below show the low-side and high-side BYPASS pin voltages of device U3 (Phase W) after VBUS = 340 VDC bus turns on. The start-up power up sequence follows the recommended start-up sequence described in section 8.1. The VBUS turn-on slew rate is set at 5 V / ms.

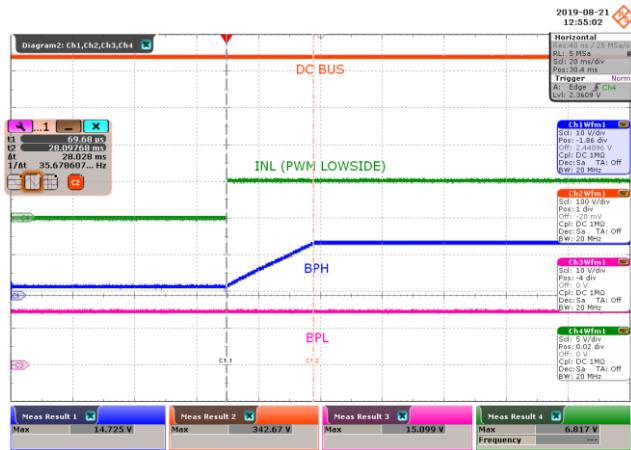
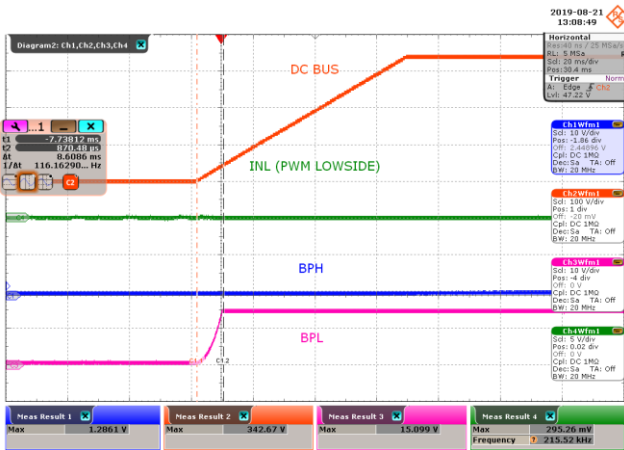

**Figure 12** – BPL/BPH Start-up at Light Load, INL = 0 V.

**Figure 13** – BPL/BPH Start-up at Light Load, INL = 5 V.

CH2:  $V_{BUS}$ , 100 V / div.  
 CH4:  $V_{INL}$ , 5 V / div.  
 CH1:  $V_{BPH}$ , 10 V / div.  
 CH3:  $V_{BPL}$ , 10 V / div.  
 Time Scale: 20 ms / div.  
 BPL Rise Time = 8.6 ms.

CH2:  $V_{BUS}$ , 100 V / div.  
 CH4:  $V_{INL}$ , 5 V / div.  
 CH1:  $V_{BPH}$ , 10 V / div.  
 CH3:  $V_{BPL}$ , 10 V / div.  
 Time Scale: 20 ms / div.  
 BPH Rise Time = 28 ms.



### 7.1.2 Motor Start-Up Waveforms

The waveforms below demonstrate the motor start-up of the BridgeSwitch inverter at light load up to 50 W loading condition. VBUS is set at 340 VDC and motor maximum speed is set at 5000 RPM.

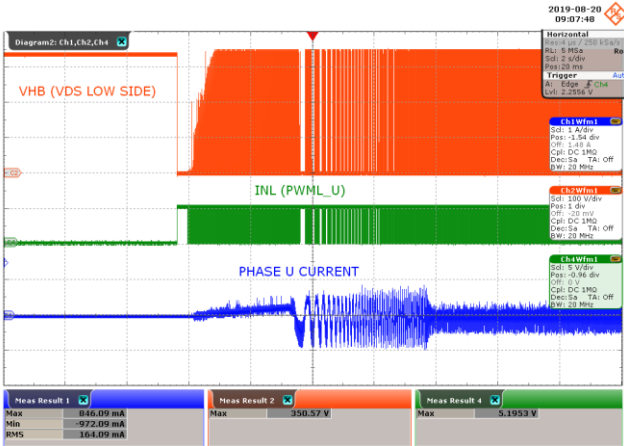

**Figure 14** – Motor Start-up at Light Load.  
 CH2:  $V_{HB}$ , 100 V / div.  
 CH4:  $V_{INL}$ , 5 V / div.  
 CH1:  $I_{PHASE\_CURRENT}$ , 1 A / div.  
 Time Scale: 2 s / div.  
 Maximum Phase Peak Current = 846 mA<sub>PK</sub>.  
 Maximum VHB Peak Voltage = 350.57 V<sub>PK</sub>.

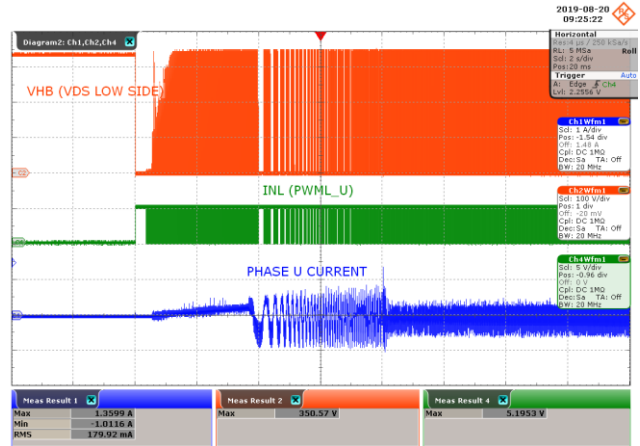

**Figure 15** – Motor Start-up at 50 W Load.  
 CH2:  $V_{HB}$ , 100 V / div.  
 CH4:  $V_{INL}$ , 5 V / div.  
 CH1:  $I_{PHASE\_CURRENT}$ , 1 A / div.  
 Time Scale: 2 s / div.  
 Maximum Phase Peak Current = 1.35 A<sub>PK</sub>.  
 Maximum VHB Peak Voltage = 350.57 V<sub>PK</sub>.



## 7.2 Steady-State Operation

### 7.2.1 Phase Voltages (Drain to Source) During Steady-State

The waveforms below show the phase voltages of the BridgeSwitch (low side drain to source voltage) 3-phase inverter using field oriented control. The maximum peak voltage was measured from light to full load (inverter load) during steady-state operation. VBUS = 340 VDC and the motor speed is 5000 RPM.

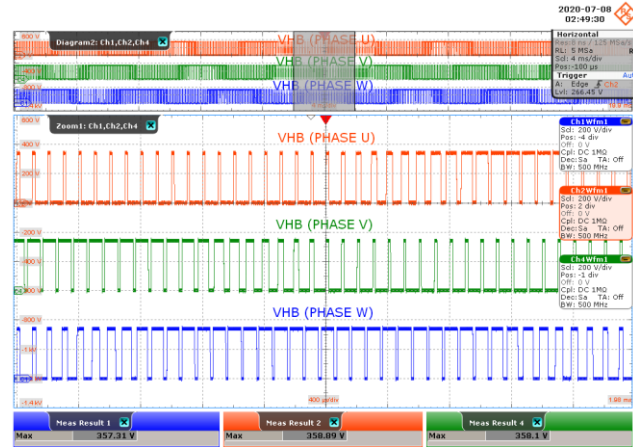
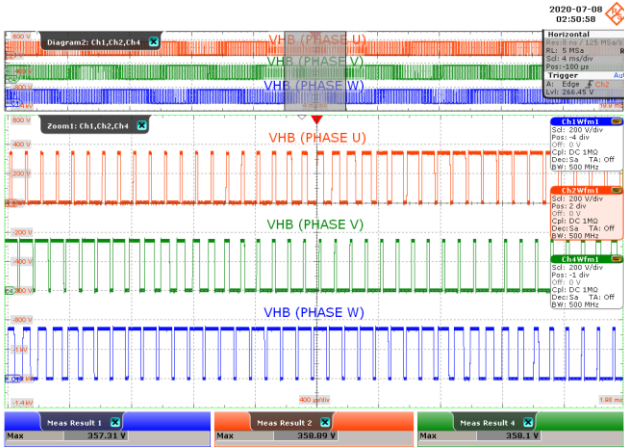
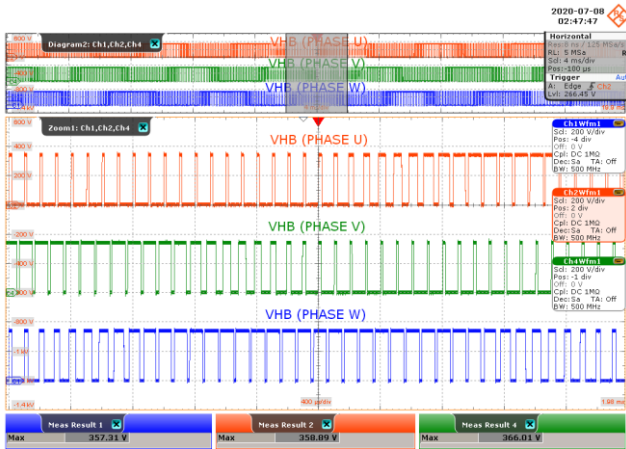

**Figure 16** – Drain to Source Voltage at Light Load.

CH2:  $V_{HB\_PHASEU}$ , 200 V / div.  
 CH4:  $V_{HB\_PHASEV}$ , 200 V / div.  
 CH1:  $V_{HB\_PHASEW}$ , 200 V / div.  
 Time Scale: 4 ms / div.  
 Maximum Peak Voltage (U) = 358.89 V<sub>PK</sub>.  
 Maximum Peak Voltage (V) = 358.10 V<sub>PK</sub>.  
 Maximum Peak Voltage (W) = 357.31 V<sub>PK</sub>.

**Figure 17** – Drain to Source Voltage at 30 W Load.

CH2:  $V_{HB\_PHASEU}$ , 200 V / div.  
 CH4:  $V_{HB\_PHASEV}$ , 200 V / div.  
 CH1:  $V_{HB\_PHASEW}$ , 200 V / div.  
 Time Scale: 4 ms / div.  
 Maximum Peak Voltage (U) = 358.89 V<sub>PK</sub>.  
 Maximum Peak Voltage (V) = 358.10 V<sub>PK</sub>.  
 Maximum Peak Voltage (W) = 357.31 V<sub>PK</sub>.



**Figure 18** – Drain to Source Voltage at 100 W Load.  
 CH2:  $V_{HB\_PHASEU}$ , 200 V / div.  
 CH4:  $V_{HB\_PHASEV}$ , 200 V / div.  
 CH1:  $V_{HB\_PHASEW}$ , 200 V / div.  
 Time Scale: 4 ms / div.  
 Maximum Peak Voltage (U) = 358.89  $V_{PK}$ .  
 Maximum Peak Voltage (V) = 366.01  $V_{PK}$ .  
 Maximum Peak Voltage (W) = 357.31  $V_{PK}$ .

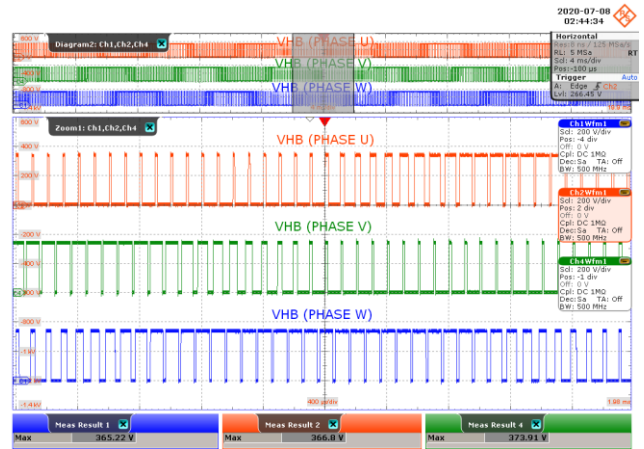
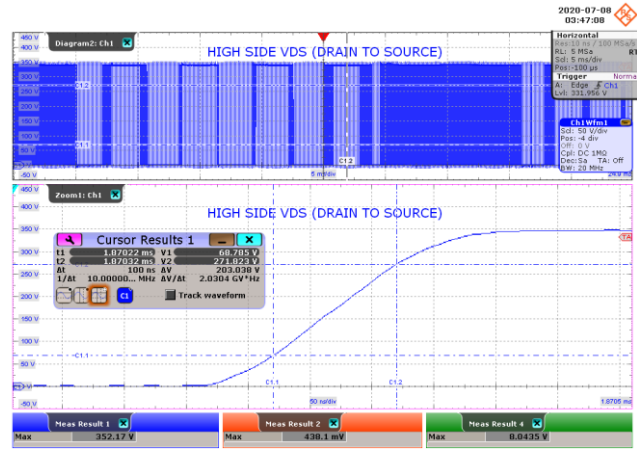
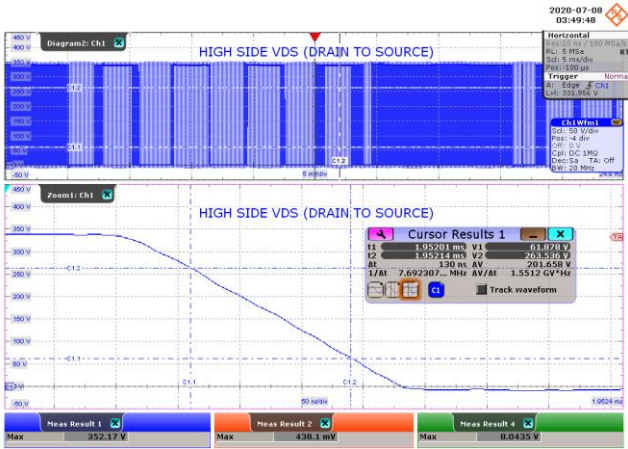

**Figure 19** – Drain to Source Voltage at 200 W Load.  
 CH2:  $V_{HB\_PHASEU}$ , 200 V / div.  
 CH4:  $V_{HB\_PHASEV}$ , 200 V / div.  
 CH1:  $V_{HB\_PHASEW}$ , 200 V / div.  
 Time Scale: 4 ms / div.  
 Maximum Peak Voltage (U) = 366.80  $V_{PK}$ .  
 Maximum Peak Voltage (V) = 373.91  $V_{PK}$ .  
 Maximum Peak Voltage (W) = 365.22  $V_{PK}$ .



### 7.2.2 High-Side Drain to Source Voltage Slew Rate

The waveforms below show the voltage slew rate at TURN ON and TURN OFF transitions of the high-side BridgeSwitch FREDFET. The measurements were taken at 340 VDC, 5000 RPM, 100 W and 200 W loading condition.



**Figure 20** –TURN ON Slew Rate, 100 W Load.  
 CH1:  $V_{DS\_HIGH\_SIDE}$ , 50 V / div.  
 Time Scale: 5 ms / div.  
 Time Scale (Zoomed Area): 50 ns / div.  
 Measured Slew Rate = 1.55 V / ns.

**Figure 21** – TURN OFF Slew Rate, 100 W Load.  
 CH1:  $V_{DS\_HIGH\_SIDE}$ , 50 V / div.  
 Time Scale: 5 ms / div.  
 Time Scale (Zoomed Area): 50 ns / div.  
 Measured Slew Rate = 2.03 V / ns.

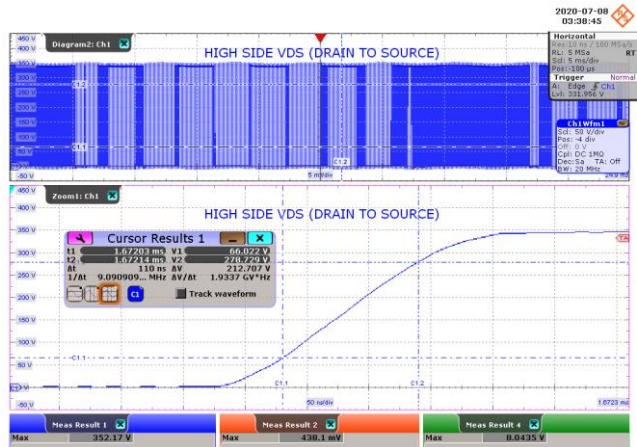
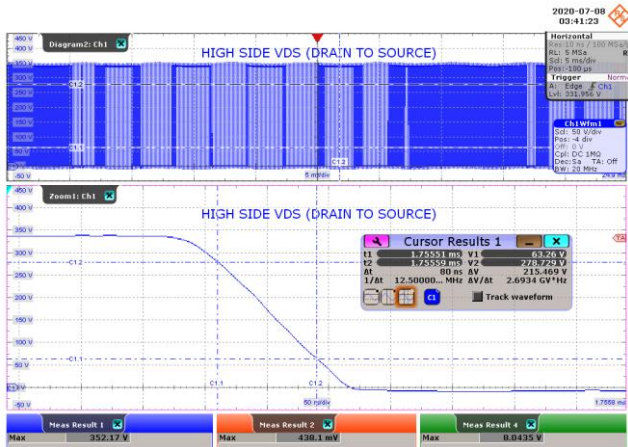

**Figure 22** –TURN ON Slew Rate, 200 W Load.  
 CH1:  $V_{DS\_HIGH\_SIDE}$ , 50 V / div.  
 Time Scale: 5 ms / div.  
 Time Scale (Zoomed Area): 50 ns / div.  
 Measured Slew Rate = 2.69 V / ns.

**Figure 23** – TURN OFF Slew Rate, 200 W Load.  
 CH1:  $V_{DS\_HIGH\_SIDE}$ , 50 V / div.  
 Time Scale: 5 ms / div.  
 Time Scale (Zoomed Area): 50 ns / div.  
 Measured Slew Rate = 1.93 V / ns.



### 7.2.3 Phase Currents During Steady-State

The waveforms below show the phase currents of the BridgeSwitch 3-phase inverter using field oriented method of control (FOC). The maximum peak currents were measured from light load to 200 W loading condition during steady-state operation.



**Figure 24** – Phase Current at Light Load.

CH1:  $I_{PHASEU}$ , 1 A / div.  
 CH2:  $I_{PHASEV}$ , 1 A / div.  
 CH3:  $I_{PHASEW}$ , 1 A / div.  
 Time Scale: 10 ms / div.  
 RMS Current (U) = 77 mA<sub>RMS</sub>.  
 RMS Current (V) = 74 mA<sub>RMS</sub>.  
 RMS Current (W) = 74 mA<sub>RMS</sub>.

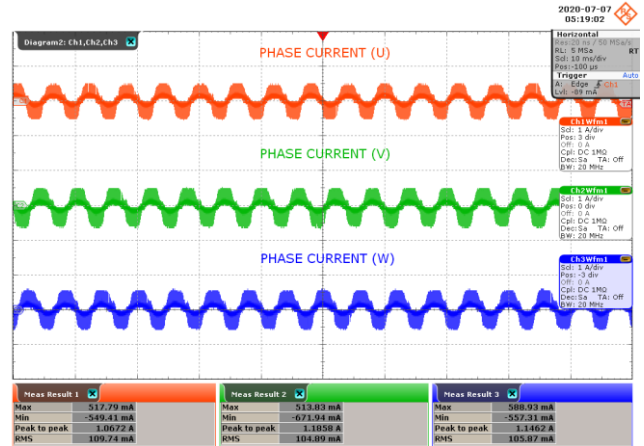

**Figure 25** – Phase Current at 30 W Load.

CH1:  $I_{PHASEU}$ , 1 A / div.  
 CH2:  $I_{PHASEV}$ , 1 A / div.  
 CH3:  $I_{PHASEW}$ , 1 A / div.  
 Time Scale: 10 ms / div.  
 RMS Current (U) = 109 mA<sub>RMS</sub>.  
 RMS Current (V) = 104 mA<sub>RMS</sub>.  
 RMS Current (W) = 105 mA<sub>RMS</sub>.

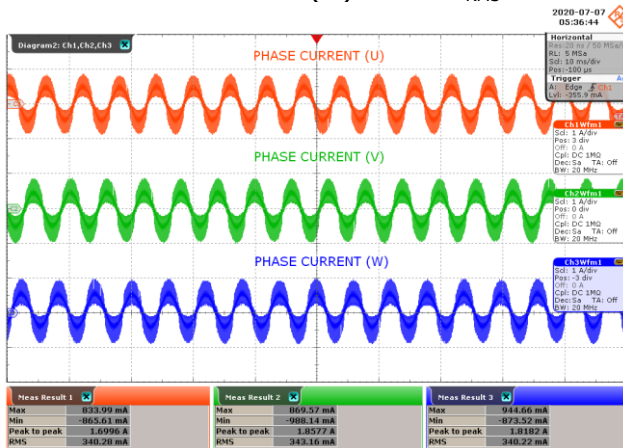

**Figure 26** – Phase Current at 100 W Load.

CH1:  $I_{PHASEU}$ , 1 A / div.  
 CH2:  $I_{PHASEV}$ , 1 A / div.  
 CH3:  $I_{PHASEW}$ , 1 A / div.  
 Time Scale: 10 ms / div.  
 RMS Current (U) = 340 mA<sub>RMS</sub>.  
 RMS Current (V) = 343 mA<sub>RMS</sub>.  
 RMS Current (W) = 340 mA<sub>RMS</sub>.

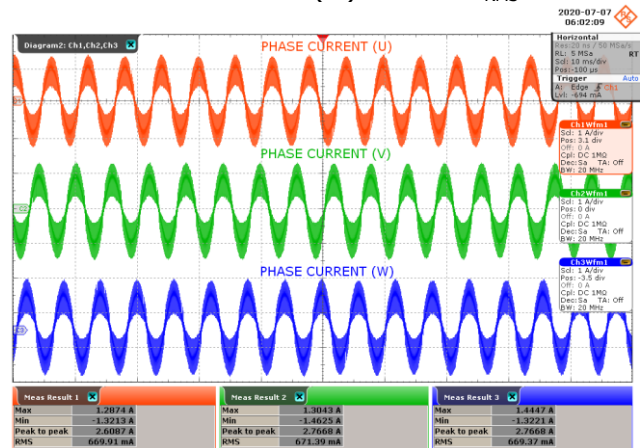

**Figure 27** – Phase Current at 200 W Load.

CH1:  $I_{PHASEU}$ , 1 A / div.  
 CH2:  $I_{PHASEV}$ , 1 A / div.  
 CH3:  $I_{PHASEW}$ , 1 A / div.  
 Time Scale: 10 ms / div.  
 RMS Current (U) = 669 mA<sub>RMS</sub>.  
 RMS Current (V) = 671 mA<sub>RMS</sub>.  
 RMS Current (W) = 669 mA<sub>RMS</sub>.



### 7.2.4 INL and /INH Signals

The waveforms below show the low-side (INL) and high-side (/INH) input PWM signals during light load and full load condition at steady-state operation. The PWM frequency is set at 10 kHz with a constant motor speed of 5000 RPM.

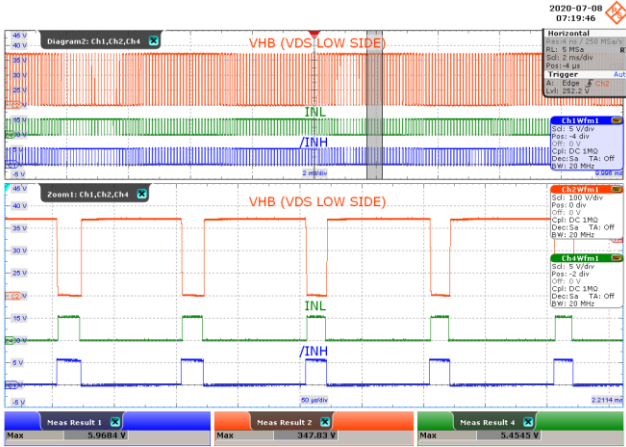

**Figure 28 – INL and /INH Signal at Light Load.**  
 CH2:  $V_{HB\_PHASEW}$ , 100 V / div.  
 CH4:  $V_{INL}$ , 5 V / div.  
 CH1:  $V_{INH}$ , 5 V / div.  
 Time Scale: 2 ms / div.  
 Time Scale (Zoomed Area): 50  $\mu$ s / div.



**Figure 29 – INL and /INH Signal at 30 W Load.**  
 CH2:  $V_{HB\_PHASEW}$ , 100 V / div.  
 CH4:  $V_{INL}$ , 5 V / div.  
 CH1:  $V_{INH}$ , 5 V / div.  
 Time Scale: 2 ms / div.  
 Time Scale (Zoomed Area): 50  $\mu$ s / div.

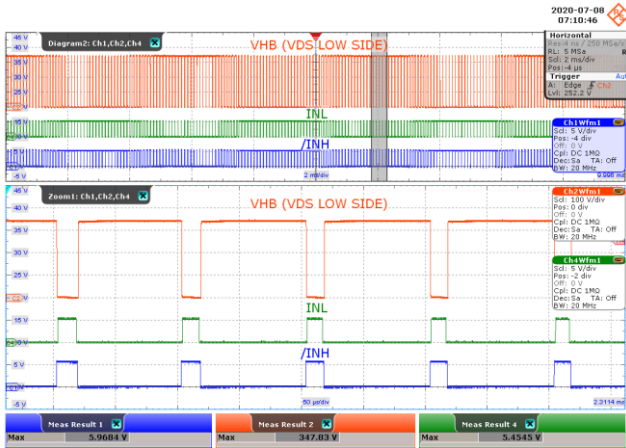

**Figure 30 – INL and /INH Signal at 100 W Load.**  
 CH2:  $V_{HB\_PHASEW}$ , 100 V / div.  
 CH4:  $V_{INL}$ , 5 V / div.  
 CH1:  $V_{INH}$ , 5 V / div.  
 Time Scale: 2 ms / div.  
 Time Scale (Zoomed Area): 50  $\mu$ s / div.

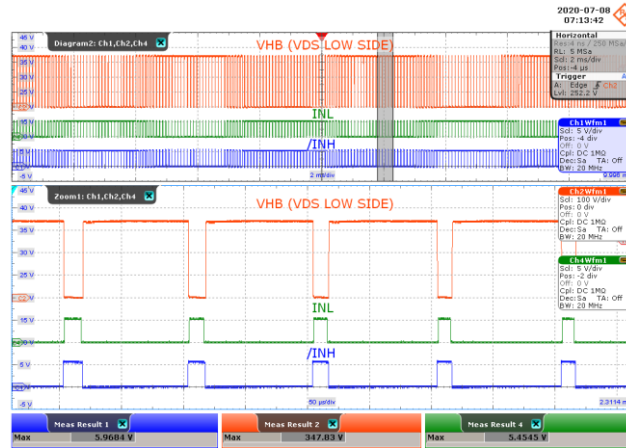

**Figure 31 – INL and /INH Signal at 200 W Load.**  
 CH2:  $V_{HB\_PHASEW}$ , 100 V / div.  
 CH4:  $V_{INL}$ , 5 V / div.  
 CH1:  $V_{INH}$ , 5 V / div.  
 Time Scale: 2 ms / div.  
 Time Scale (Zoomed Area): 50  $\mu$ s / div.



### 7.2.5 BPL and BPH during Steady-State

The waveforms below show the BPL and BPH (low-side and high-side self-supply bias level respectively) from light load to full load condition during steady-state operation.



**Figure 32** – BPL and BPH Signal at Light Load.  
 CH2:  $V_{HB\_PHASEW}$ , 100 V / div.  
 CH4:  $V_{BPL}$ , 10 V / div.  
 CH1:  $V_{BPH}$ , 10 V / div.  
 Time Scale: 4 ms / div.  
 BPL Average Voltage = 14.17 V.  
 BPH Average Voltage = 14.44 V.



**Figure 33** – BPL and BPH Signal at 30W Load.  
 CH2:  $V_{HB\_PHASEW}$ , 100 V / div.  
 CH4:  $V_{BPL}$ , 10 V / div.  
 CH1:  $V_{BPH}$ , 10 V / div.  
 Time Scale: 4 ms / div.  
 BPL Average Voltage = 14.18 V.  
 BPH Average Voltage = 14.45 V.



**Figure 34** – BPL and BPH Signal at 100W Load.  
 CH2:  $V_{HB\_PHASEW}$ , 100 V / div.  
 CH4:  $V_{BPL}$ , 10 V / div.  
 CH1:  $V_{BPH}$ , 10 V / div.  
 Time Scale: 4 ms / div.  
 BPL Average Voltage = 14.18 V.  
 BPH Average Voltage = 14.44 V.



**Figure 35** – BPL and BPH Signal at 200W Load.  
 CH2:  $V_{HB\_PHASEW}$ , 100 V / div.  
 CH4:  $V_{BPL}$ , 10 V / div.  
 CH1:  $V_{BPH}$ , 10 V / div.  
 Time Scale: 4 ms / div.  
 BPL Average Voltage = 14.18 V.  
 BPH Average Voltage = 14.43 V.



### 7.3 Thermal Performance

The thermal scans below depict on-board device thermal performance after 20 minutes each for 30 W, 100 W, and 200 W inverter output power running at a constant speed of 5000 RPM, 10 kHz PWM switching frequency, 3-phase FOC modulation, BridgeSwitch device at self and external supply mode, with an ambient temperature of 27 deg C. The auxiliary circuit, +5 V linear regulator, and input diode were disabled to solely reflect the inverter temperature by depopulating components U4, U5, and D6. An external +5 VDC supply was provided between pins +5 V and GND for the microcontroller and current sense amplifier. An additional +17 VDC supply was used during external supply mode.

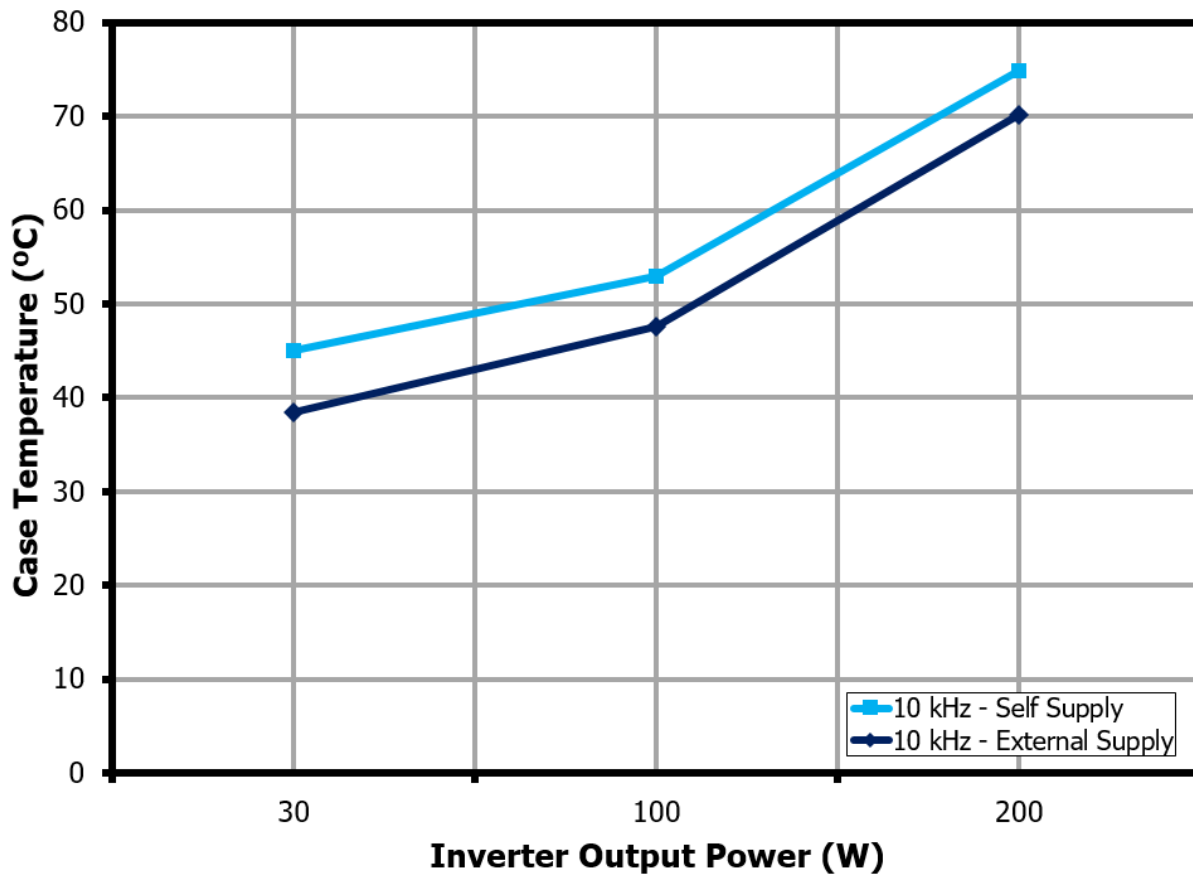

Figure 36 – Thermal Performance at Self and External Supply Mode.

7.3.1 30 W Loading Condition (105 mA Average Motor Phase Current)

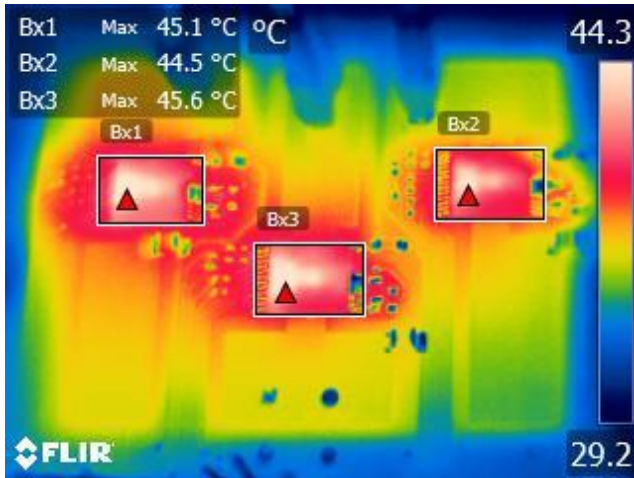

Figure 37 – Self Supply Mode.

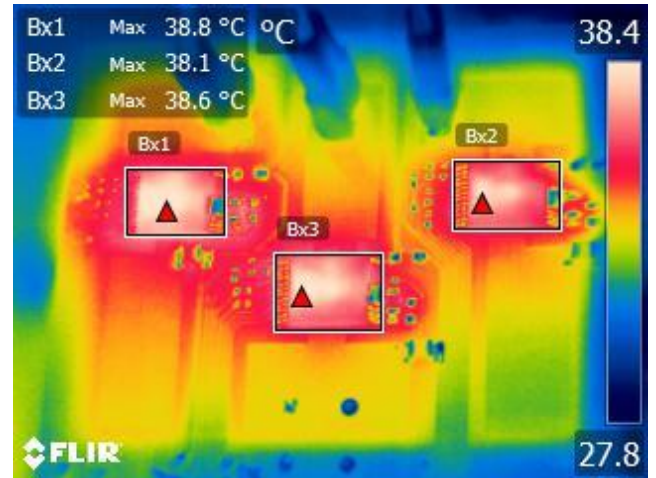

Figure 38 – External Supply Mode.

7.3.2 100 W Loading Condition (340 mA Average Motor Phase Current)

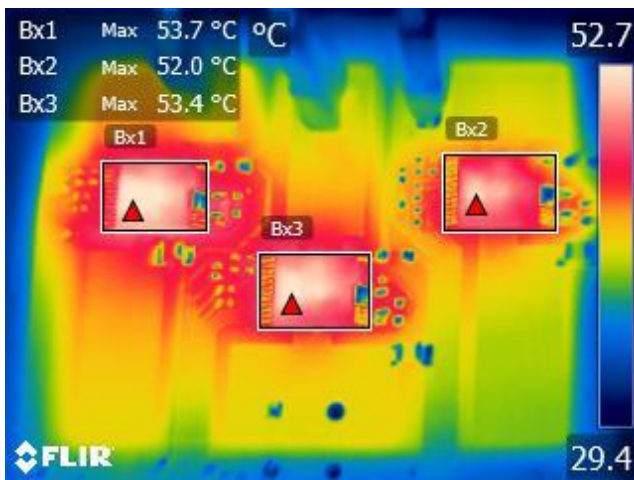

Figure 39 – Self Supply Mode.

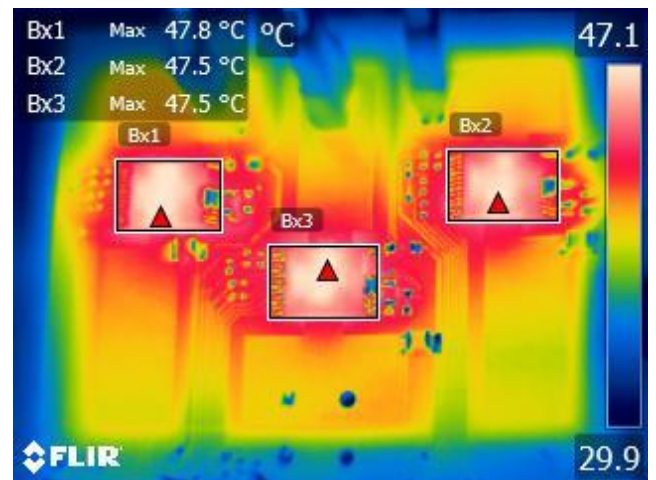

Figure 40 – External Supply Mode.

7.3.3 200 W Loading Condition (670 mA Average Motor Phase Current)

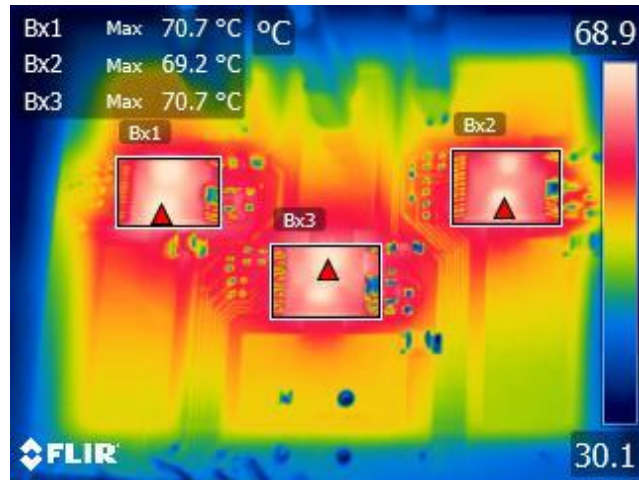
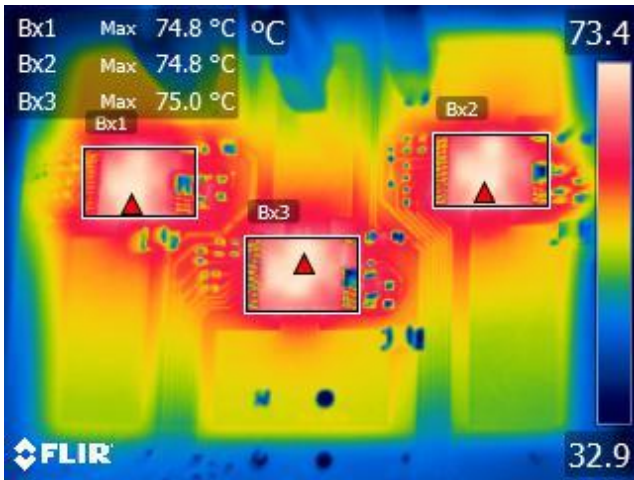

Figure 41 – Self Supply Mode.

Figure 42 – External Supply Mode.

7.3.4 Thermal Scan Summary Tables

7.3.4.1 Self Supply Mode

Phase	Device	Inverter Output Power		
		30 W	100 W	200 W
U	U1	45.1	53.7	74.8
V	U2	44.5	52.0	74.8
W	U3	45.6	53.4	75.0
	Ave.Temp	45.1	53.0	74.9

7.3.4.2 External Supply Mode

Phase	Device	Inverter Output Power		
		30 W	100 W	200 W
U	U1	38.8	47.8	70.7
V	U2	38.1	47.5	69.2
W	U3	38.6	47.5	70.7
	Ave.Temp	38.5	47.6	70.2

### 7.4 **No-Load Input Power Consumption**

The graph below shows the BridgeSwitch 3-phase inverter no-load input power measured at different input voltages. Voltage was measured directly at the positive input DC BUS of the inverter. The auxiliary circuit, +5 V linear regulator, and current sense amplifier were disabled by depopulating components U4, U5, and U6.

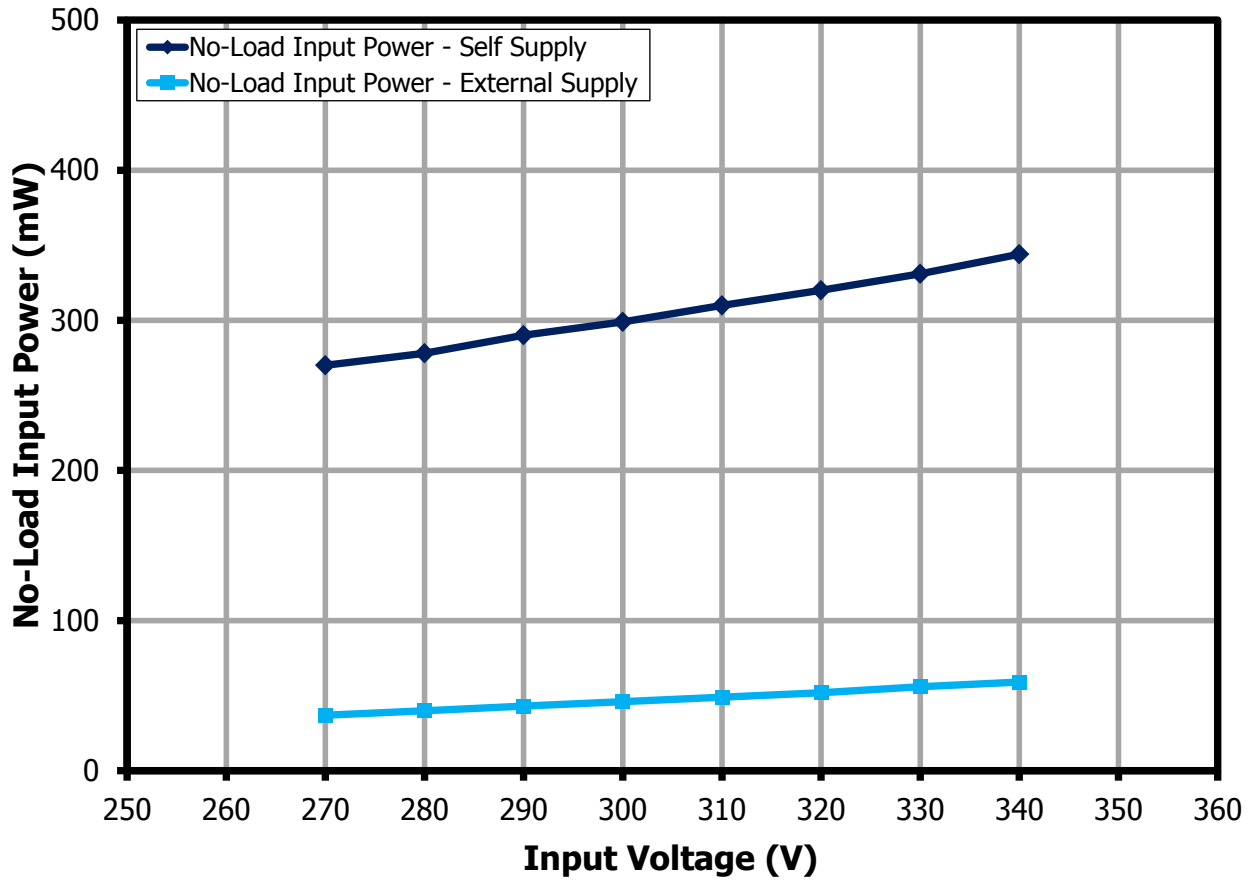

Figure 43 – No-Load Input Power.



### 7.5 Efficiency

The graph and table below shows the BridgeSwitch inverter efficiency at 340 VDC input, 10 kHz PWM switching frequency, a constant motor speed of 5000 RPM, 3-phase FOC modulation, BridgeSwitch devices at self and external supply mode, and at room ambient temperature. The auxiliary circuit, +5 V linear regulator, input diode, and current sense amplifier were disabled for efficiency data accuracy. This was accomplished by measuring the input voltage directly at the positive input DC BUS of the inverter, and depopulating components U4, U5, and D6. An external +5 VDC supply was provided between pins +5 V and GND for the microcontroller and current sense amplifier. An additional +17 VDC supply was used during external supply mode.

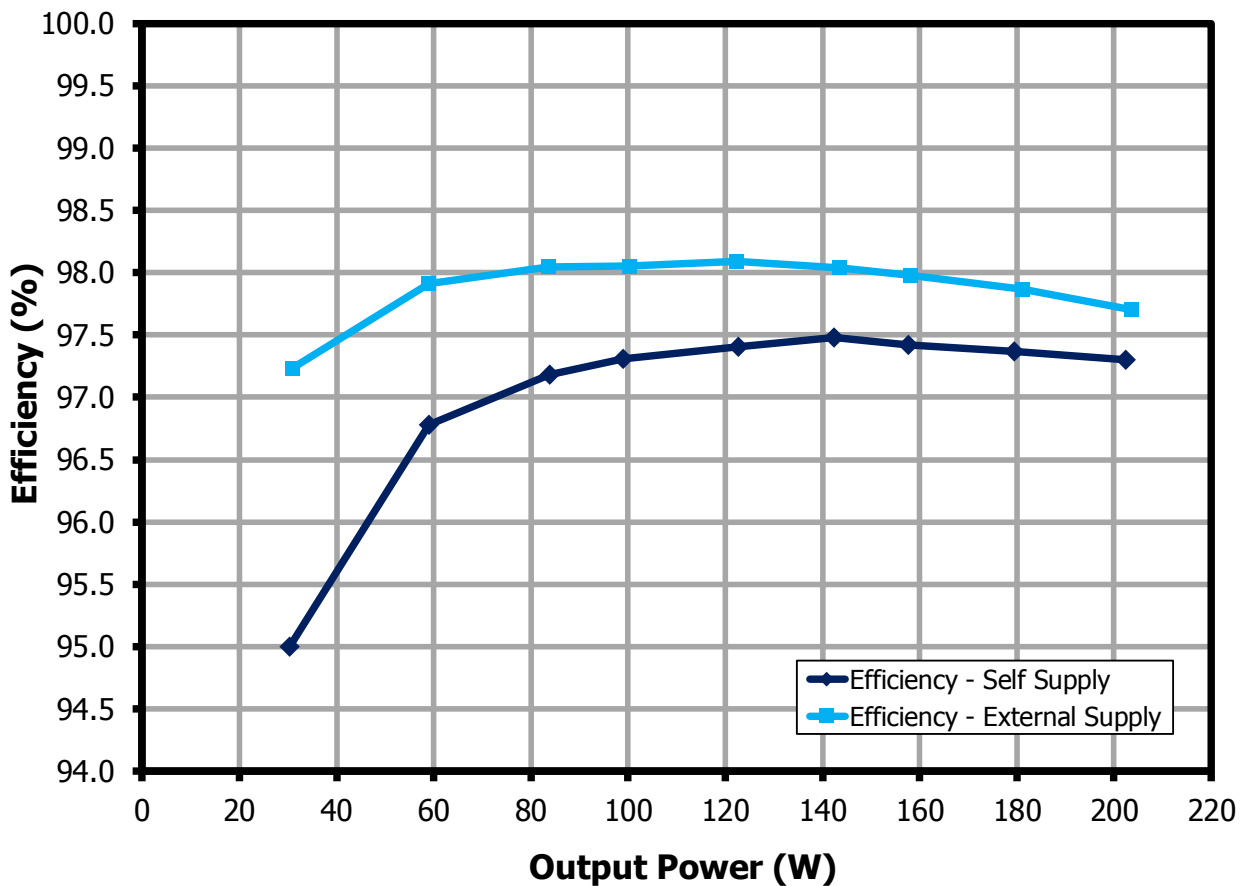

Figure 44 – Inverter Efficiency Graph.

## 7.5.1 Efficiency Table at Self Supply Mode

DC Input Voltage ( $V_{IN}$ )	Input DC Current (mA)	Input Power (W)	$I_{RMSU}$ (mA)	$I_{RMSV}$ (mA)	$I_{RMSW}$ (mA)	Inverter Output Power (W)	Inverter Efficiency (%)
340	94	31.96	111	105	102	30.36	95.00
340	179	61.06	205	204	201	59.09	96.78
340	253	86.24	285	288	283	83.81	97.18
340	299	101.78	335	337	334	99.04	97.31
340	370	125.88	414	412	411	122.61	97.40
340	429	146.04	477	475	472	142.36	97.48
340	476	161.89	524	521	517	157.71	97.42
340	542	184.39	597	597	594	179.54	97.37
340	612	208.09	670	670	667	202.47	97.30

Table 2 – Efficiency Table with BridgeSwitch at Self Supply Mode.

## 7.5.2 Efficiency Table at External Supply Mode

DC Input Voltage ( $V_{IN}$ )	Input DC Current (mA)	Input Power (W)	$I_{RMSU}$ (mA)	$I_{RMSV}$ (mA)	$I_{RMSW}$ (mA)	Inverter Output Power (W)	Inverter Efficiency (%)
340	94	31.83	115	110	109	30.95	97.23
340	177	60.31	205	197	198	59.05	97.91
340	251	85.34	289	285	280	83.67	98.04
340	301	102.34	343	344	341	100.35	98.06
340	366	124.59	411	414	408	122.21	98.09
340	430	146.45	481	484	479	143.58	98.04
340	474	161.28	527	531	526	158.02	97.98
340	544	185.09	600	604	599	181.14	97.87
340	612	208.33	669	674	668	203.55	97.71

Table 3 – Efficiency Table with BridgeSwitch at External Supply Mode.



## 7.6 Device and System Level Protection / Monitoring

### 7.6.1 Overcurrent Protection (OCP)

The waveforms below show the current limit triggering of the BridgeSwitch device. For this test, current set resistors  $R_{XL}$  and  $R_{XH}$  were adjusted to 115 k $\Omega$  resulting in a current limit of approximately 1 A<sub>pk</sub>.

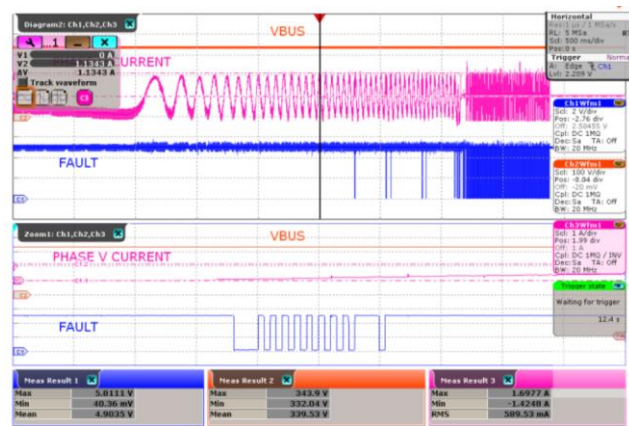

**Figure 45** – OCP at  $R_{XL}/R_{XH} = 115 \text{ k}\Omega$ ,  $I_{LIM} = 1 \text{ A}$ .  
 CH2:  $V_{BUS}$ , 100 V / div.  
 CH3:  $I_{PHASE}$ , 1 A / div.  
 CH1:  $V_{FAULT}$ , 2 V / div.  
 Time Scale: 500 ms / div.  
 Time Scale (Zoomed Area): 100  $\mu\text{s}$  / div.  
 FAULT Flag Reading = 0000010.

**Figure 46** – OCP Fault Clear at  $R_{XL}/R_{XH} = 115 \text{ k}\Omega$ .  
 CH2:  $V_{BUS}$ , 100 V / div.  
 CH3:  $I_{PHASE}$ , 1 A / div.  
 CH1:  $V_{FAULT}$ , 2 V / div.  
 Time Scale: 500 ms / div.  
 Time Scale (Zoomed Area): 100  $\mu\text{s}$  / div.  
 FAULT Clear = 0000000.



### 7.6.2 Thermal Warning

The waveforms below depict the low-side FREDFET over-temperature warning. A localized external heat source was applied to the device to force temperature rise.

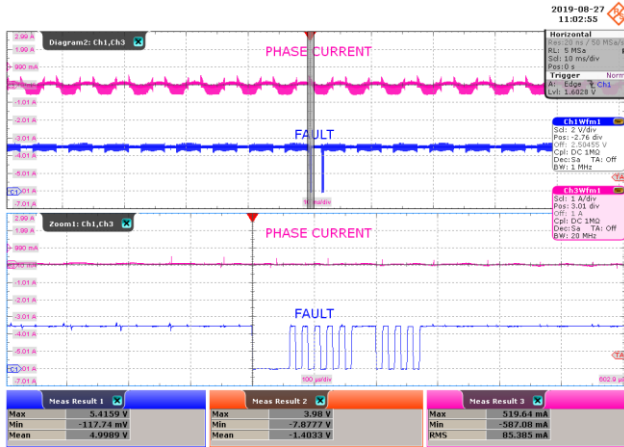

**Figure 47** – Thermal Warning at No-Load.  
 CH3: I<sub>PHASE</sub>, 1 A / div.  
 CH1: V<sub>FAULT</sub>, 2 V / div.  
 Time Scale: 10 ms / div.  
 Time Scale (Zoomed Area): 100 μs / div.  
 FAULT Flag/Reading = 0000100.

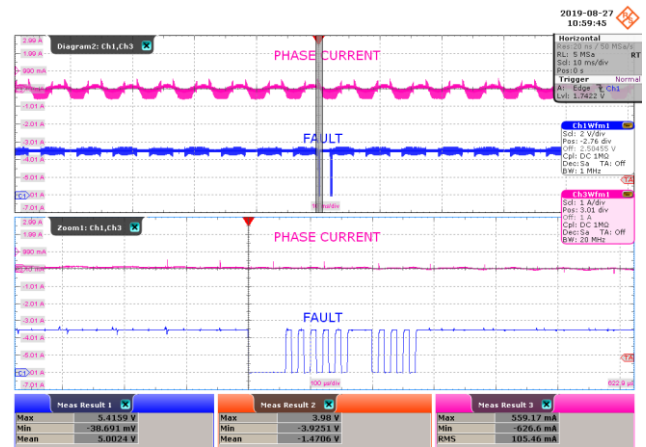

**Figure 48** – Thermal Warning at 30 W.  
 CH3: I<sub>PHASE</sub>, 1 A / div.  
 CH1: V<sub>FAULT</sub>, 2 V / div.  
 Time Scale: 10 ms / div.  
 Time Scale (Zoomed Area): 100 μs / div.  
 FAULT Flag/Reading = 0000100.

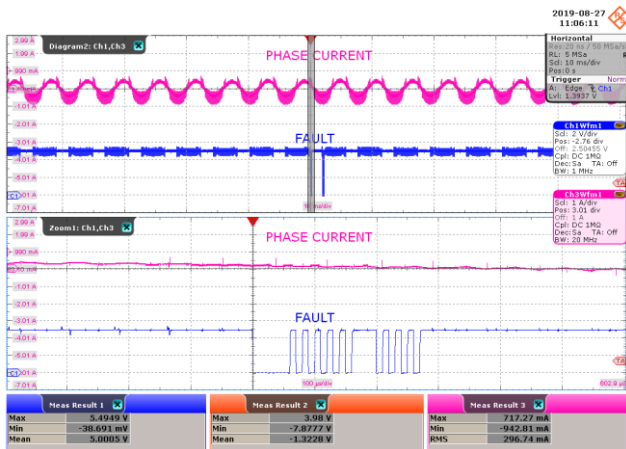

**Figure 49** – Thermal Warning at 100 W.  
 CH3: I<sub>PHASE</sub>, 1 A / div.  
 CH1: V<sub>FAULT</sub>, 2 V / div.  
 Time Scale: 10 ms / div.  
 Time Scale (Zoomed Area): 100 μs / div.  
 FAULT Flag/Reading = 0000100.

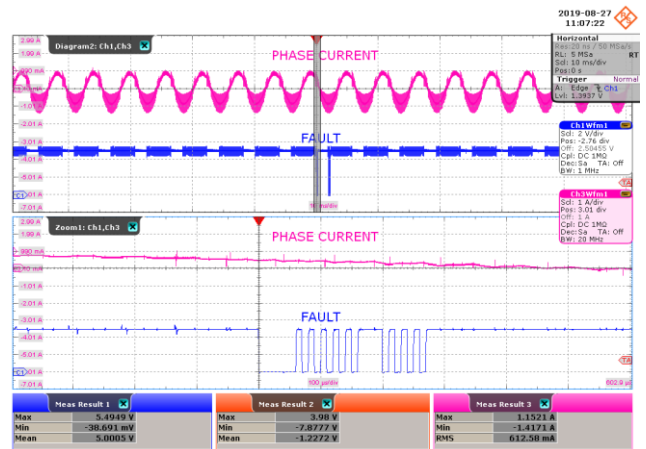
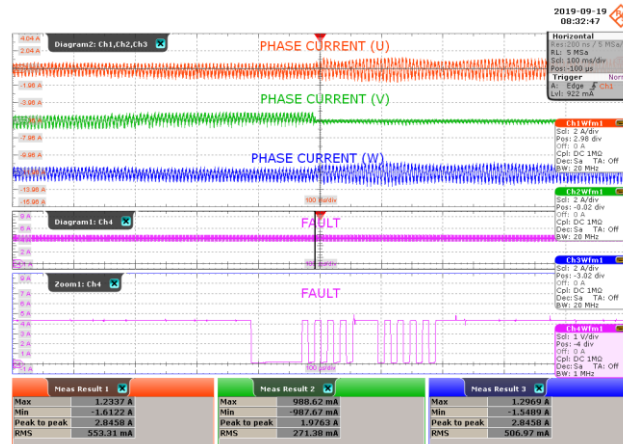

**Figure 50** – Thermal Warning at 200 W.  
 CH3: I<sub>PHASE</sub>, 1 A / div.  
 CH1: V<sub>FAULT</sub>, 2 V / div.  
 Time Scale: 10 ms / div.  
 Time Scale (Zoomed Area): 100 μs / div.  
 FAULT Flag/Reading = 0000100.



### 7.6.3 Thermal Shutdown

The waveform below depicts the low-side FREDFET over-temperature shutdown. A localized external heat source was applied to a single BridgeSwitch device (U2) to force temperature rise while the inverter is running at 100 W loading condition.



**Figure 51** – Thermal Shutdown.

CH1:  $I_{PHASEU}$ , 2 A / div.

CH2:  $I_{PHASEV}$ , 2 A / div.

CH3:  $I_{PHASEW}$ , 2 A / div.

CH4:  $V_{FAULT}$ , 1 V / div.

Time Scale: 100 ms / div.

Time Scale (Zoomed FAULT): 100 μs / div.

FAULT Flag/Reading = 0001000.

### 7.6.4 Undervoltage (UV)

The test results below demonstrate the integrated bus UV monitoring function and status reporting through the communication bus (FAULT pin). Device U1 senses the bus voltage through resistors R21, R22, and R23.

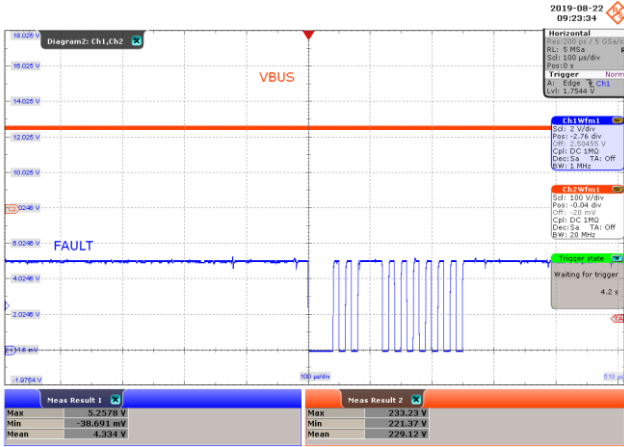

**Figure 52** – UVP, 5000 RPM, No-Load, 340 V to 220 V.  
 CH2:  $V_{BUS}$ , 100 V / div.  
 CH1:  $V_{FAULT}$ , 2 V / div.  
 Time Scale: 100  $\mu$ s / div.  
 UV Level = 100%.  
 FAULT Flag Reading = 0100000.

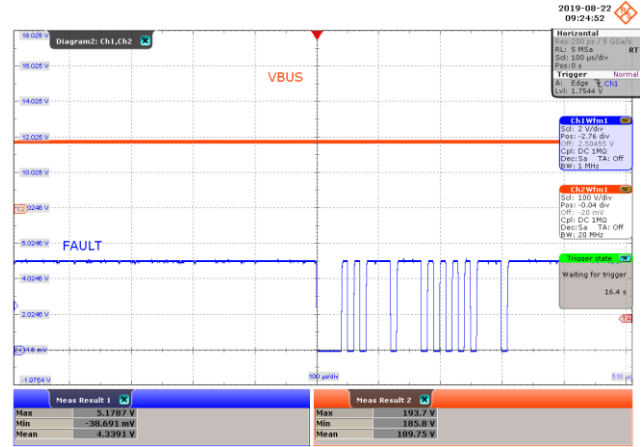

**Figure 53** – UVP, 5000 RPM, No-Load, 220 V to 190 V.  
 CH2:  $V_{BUS}$ , 100 V / div.  
 CH1:  $V_{FAULT}$ , 2 V / div.  
 Time Scale: 100  $\mu$ s / div.  
 UV Level = 85%.  
 FAULT Flag Reading = 0110000.

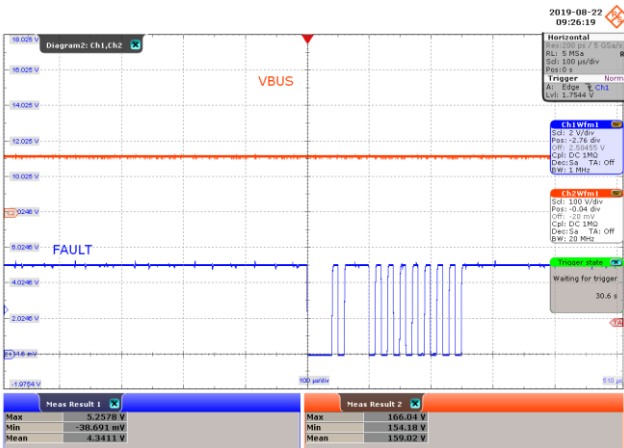

**Figure 54** – UVP, 5000 RPM, No-Load, 190 V to 160 V.  
 CH2:  $V_{BUS}$ , 100 V / div.  
 CH1:  $V_{FAULT}$ , 2 V / div.  
 Time Scale: 100  $\mu$ s / div.  
 UV Level = 70%.  
 FAULT Flag Reading = 1000000.

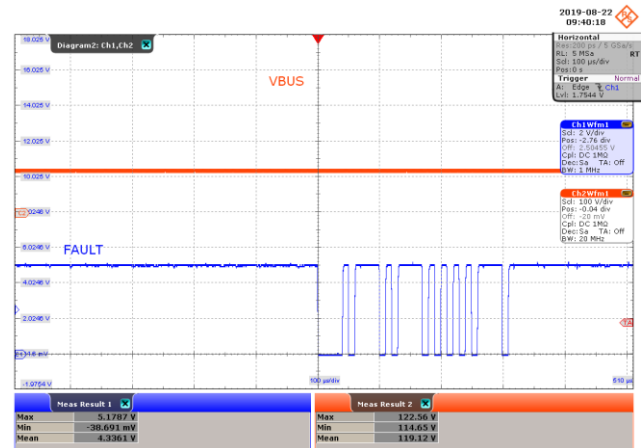
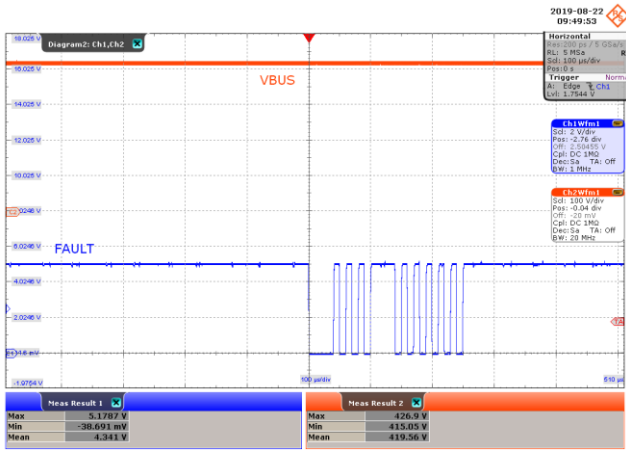

**Figure 55** – UVP, 5000 RPM, No-Load, 160 V to 120 V.  
 CH2:  $V_{BUS}$ , 100 V / div.  
 CH1:  $V_{FAULT}$ , 2 V / div.  
 Time Scale: 100  $\mu$ s / div.  
 UV Level = 55%.  
 FAULT Flag Reading = 1010000.



### 7.6.5 Overvoltage (OV)

The waveforms below illustrate the bus OV monitoring feature. The bus sensing resistance is set at 7 MΩ (total value of R21, R22, and R23) giving an overvoltage (OV) level threshold of 422 VDC. The BridgeSwitch device stops switching and reports the OV fault condition as soon as the bus voltage exceeds the OV threshold. Switching resumes after the bus voltage level drops below the OV detection threshold.



**Figure 56** – OVP, 340 V to 425 V.  
 CH2: V<sub>BUS</sub>, 100 V / div.  
 CH1: V<sub>FAULT</sub>, 2 V / div.  
 Time Scale: 100 μs / div.  
 Measured OVP Level = 426.90 V.  
 FAULT Flag/Reading = 0010000.

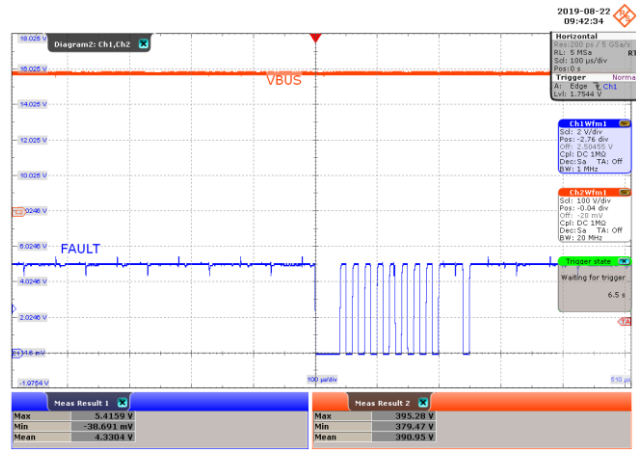

**Figure 57** – OVP Clear, 425 V to 340 V.  
 CH2: V<sub>BUS</sub>, 100 V / div.  
 CH1: V<sub>FAULT</sub>, 2 V / div.  
 Time Scale: 100 μs / div.  
 OV Fault Clear.  
 FAULT Flag/Reading = 0000000.

### 7.6.6 System Thermal Fault

The waveforms below show the system thermal warning flag of the BridgeSwitch device through an external thermistor RT1. The device checks the resistance connected to the SM pin every 1 second for a period of 10 ms. The system temperature fault was simulated by applying a localized external heat to sense thermistor RT1 with the motor running at different loading conditions.

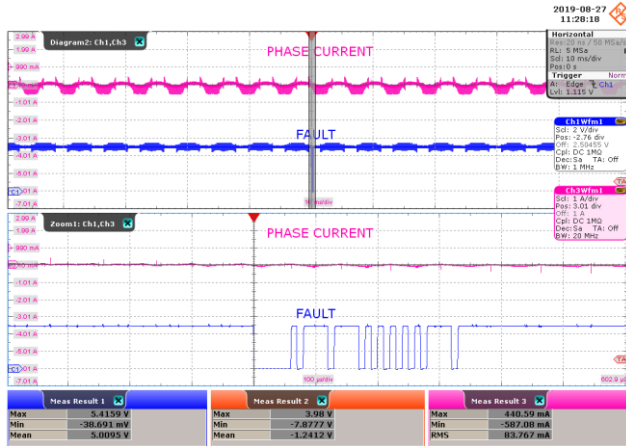

**Figure 58** – System Thermal Fault, 5000 RPM, Light Load.  
 CH3:  $I_{PHASE}$ , 1 A / div.  
 CH1:  $V_{FAULT}$ , 2 V / div.  
 Time Scale: 10 ms / div.  
 Time Scale (Zoomed Area): 100  $\mu$ s / div.  
 FAULT Flag/Reading = 1100000.

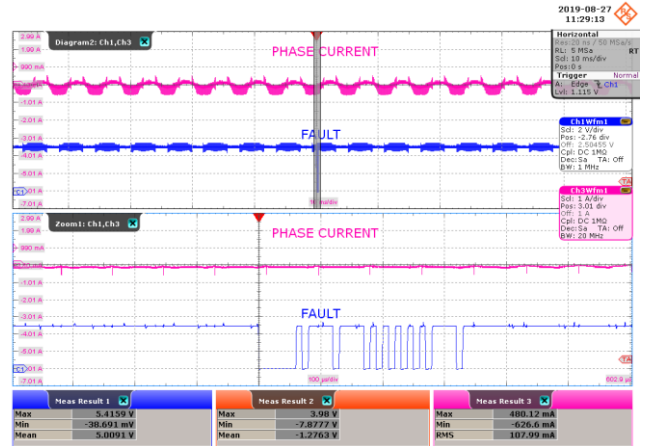

**Figure 59** – System Thermal Fault, 5000 RPM, 30 W Load.  
 CH3:  $I_{PHASE}$ , 1 A / div.  
 CH1:  $V_{FAULT}$ , 2 V / div.  
 Time Scale: 10 ms / div.  
 Time Scale (Zoomed Area): 100  $\mu$ s / div.  
 FAULT Flag/Reading = 1100000.

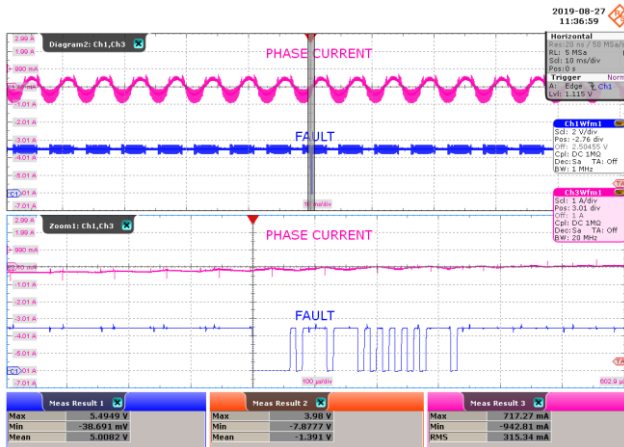

**Figure 60** – System Thermal Fault, 5000 RPM, 100 W.  
 CH3:  $I_{PHASE}$ , 1 A / div.  
 CH1:  $V_{FAULT}$ , 2 V / div.  
 Time Scale: 10 ms / div.  
 Time Scale (Zoomed Area): 100  $\mu$ s / div.  
 FAULT Flag/Reading = 1100000.

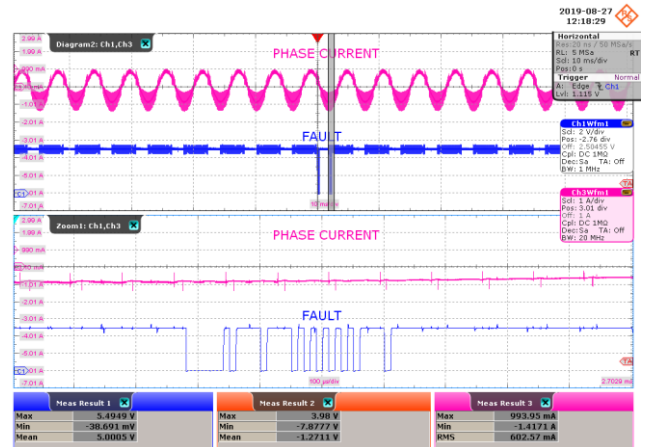

**Figure 61** – System Thermal Fault, 5000 RPM, 200 W.  
 CH3:  $I_{PHASE}$ , 1 A / div.  
 CH1:  $V_{FAULT}$ , 2 V / div.  
 Time Scale: 10 ms / div.  
 Time Scale (Zoomed Area): 100  $\mu$ s / div.  
 FAULT Flag/Reading = 1100000.



### 7.7 **Abnormal Motor Operation Test**

This paragraph provides results during abnormal operation tests for appliances with motors as described in IEC 60335-1 (Safety of household and similar electrical appliances). The tests include:

- Operation under stalled motor conditions
- Operation with one motor winding disconnected
- Running overload test

The test results demonstrate the integrated protection features of the BridgeSwitch under such abnormal operations.

#### 7.7.1 Operation Under Stalled (Motor) Conditions

For the motor stalled condition, the inverter is initially running at 340 VDC, 100 W and 200 W output load, and a motor speed of 5000 RPM. The load was then ramped up drastically to simulate sudden brake or sudden stoppage of motor rotation.

Stalled Condition at 100 W

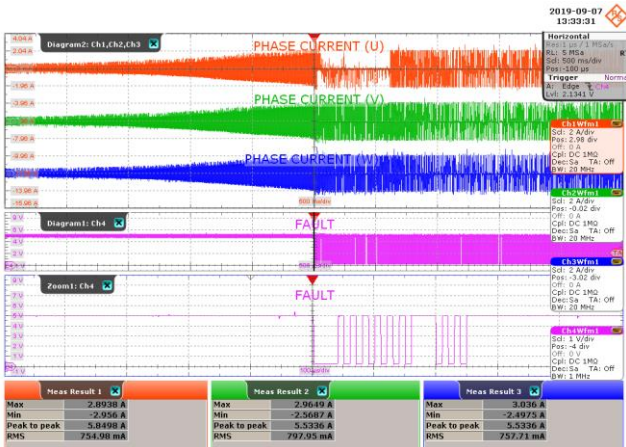

**Figure 62** – At Stalled Condition, 100 W Load.

CH1:  $I_{PHASE(U)}$ , 2 A / div.  
 CH2:  $I_{PHASE(V)}$ , 2 A / div.  
 CH3:  $I_{PHASE(W)}$ , 2 A / div.  
 CH4:  $V_{FAULT}$ , 1 V / div.  
 Time Scale: 500 ms / div.  
 Time Scale (Zoomed): 100  $\mu$ s / div.  
 1<sup>st</sup> FAULT = 0000010, LS FET OC.

Stalled Condition at 200 W

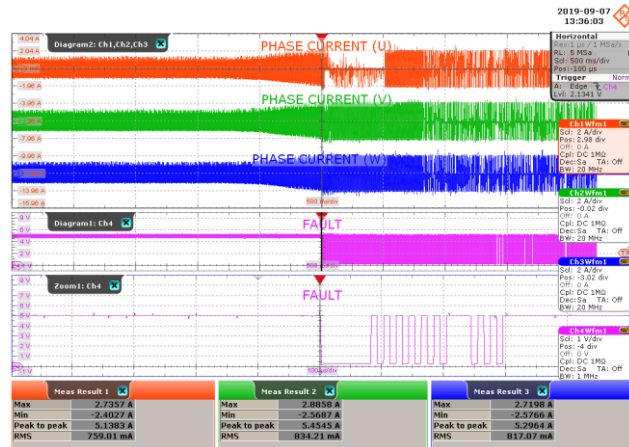

**Figure 63** – At Stalled Condition, 200 W Load.

CH1:  $I_{PHASE(U)}$ , 2 A / div.  
 CH2:  $I_{PHASE(V)}$ , 2 A / div.  
 CH3:  $I_{PHASE(W)}$ , 2 A / div.  
 CH4:  $V_{FAULT}$ , 1 V / div.  
 Time Scale: 500 ms / div.  
 Time Scale (Zoomed): 100  $\mu$ s / div.  
 1<sup>st</sup> FAULT = 0000010, LS FET OC.



7.7.2 Operation with One Motor Phase / Winding Disconnected

The figures below depict the motor phase currents and fault flag during operation with one motor winding disconnected. One phase is disconnected while the motor is running at 100 W and 200 W load (at 340 VDC input, and a motor speed of 5000 RPM). Reconnection of phase was also tested per loading condition to determine the robustness of the BridgeSwitch inverter. No damage was incurred in the motor, as well as in the BridgeSwitch inverter during and after the test.

One Phase Disconnected at 100 W

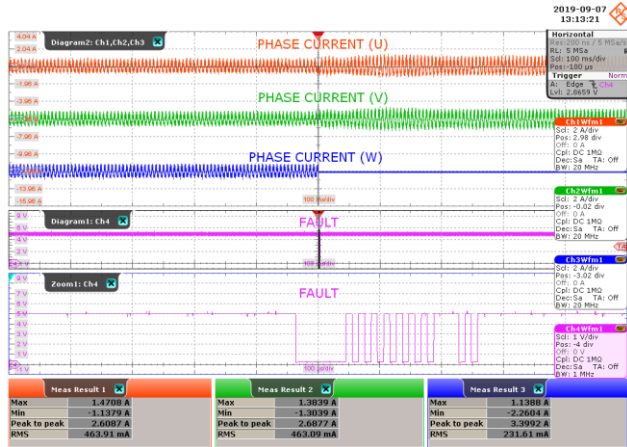

**Figure 64** – At Running Condition, 340 VDC Input.  
 CH1:  $I_{PHASE(U)}$ , 2 A / div.  
 CH2:  $I_{PHASE(V)}$ , 2 A / div.  
 CH3:  $I_{PHASE(W)}$ , 2 A / div.  
 CH4:  $V_{FAULT}$ , 1 V / div.  
 Time Scale: 100 ms / div.  
 Time Scale (Zoomed FAULT): 100  $\mu$ s / div.  
 FAULT Flag = 0000010, LS FET OC.

One Phase Reconnected at 100 W

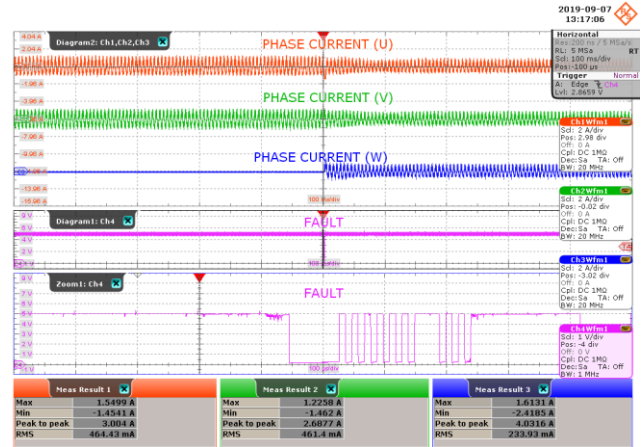

**Figure 65** – At Running Condition, 340 VDC Input.  
 CH1:  $I_{PHASE(U)}$ , 2 A / div.  
 CH2:  $I_{PHASE(V)}$ , 2 A / div.  
 CH3:  $I_{PHASE(W)}$ , 2 A / div.  
 CH4:  $V_{FAULT}$ , 1 V / div.  
 Time Scale: 100 ms / div.  
 Time Scale (Zoomed FAULT): 100  $\mu$ s / div.  
 FAULT Flag = 0000010, LS FET OC.



One Phase Disconnected at 200 W

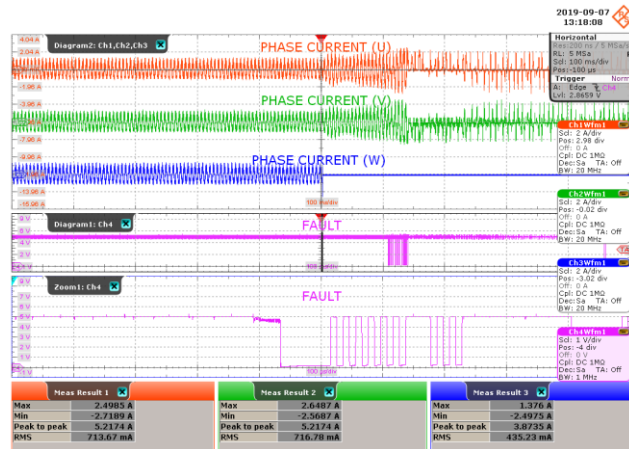

Figure 66 – At Running Condition, 340 VDC Input.

CH1:  $I_{PHASE(U)}$ , 2 A / div.

CH2:  $I_{PHASE(V)}$ , 2 A / div.

CH3:  $I_{PHASE(W)}$ , 2 A / div.

CH4:  $V_{FAULT}$ , 1 V / div.

Time Scale: 100 ms / div.

Time Scale (Zoomed FAULT): 100  $\mu$ s / div.

FAULT Flag = 0000010, LS FET OC.

**Note:** During 200 W loss of phase condition, the motor stops rotating or remains in stalled condition even when the phase is reconnected.



### 7.7.3 Running Overload Test

The figures below depict the motor phase currents and status update flag during a running overload fault condition. During this test, the motor load is increased such that the current through the motor windings increases by 10% until steady conditions are established. The load is then increased again and the test repeats until the BridgeSwitch protection engages or the motor stalls. During the overload condition, the motor is non-operational with no device or motor damage.

#### Overload Test >200 W

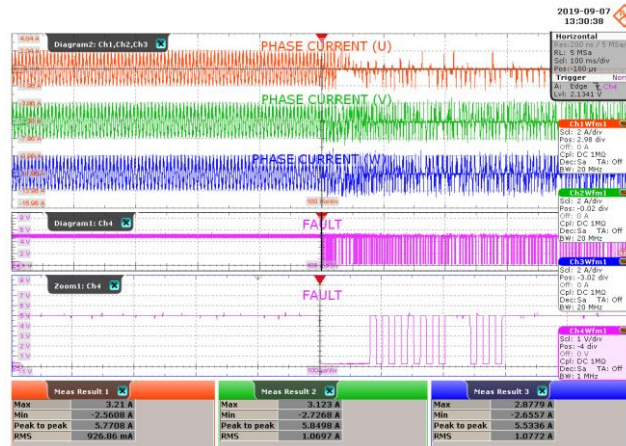

**Figure 67** – At Running Condition, 340 VDC Input.

CH1:  $I_{\text{PHASE(U)}}$ , 2 A / div.

CH2:  $I_{\text{PHASE(V)}}$ , 2 A / div.

CH3:  $I_{\text{PHASE(W)}}$ , 2 A / div.

CH4:  $V_{\text{FAULT}}$ , 1 V / div.

Time Scale: 100 ms / div.

Time Scale (Zoomed FAULT): 100  $\mu$ s / div.

1<sup>st</sup> FAULT Flag = 000010, LS FET Over-Current.

**Note:** During the overload condition, the motor stops rotating or remains in stalled condition.

## 8 Appendix

### 8.1 Board Quick Reference

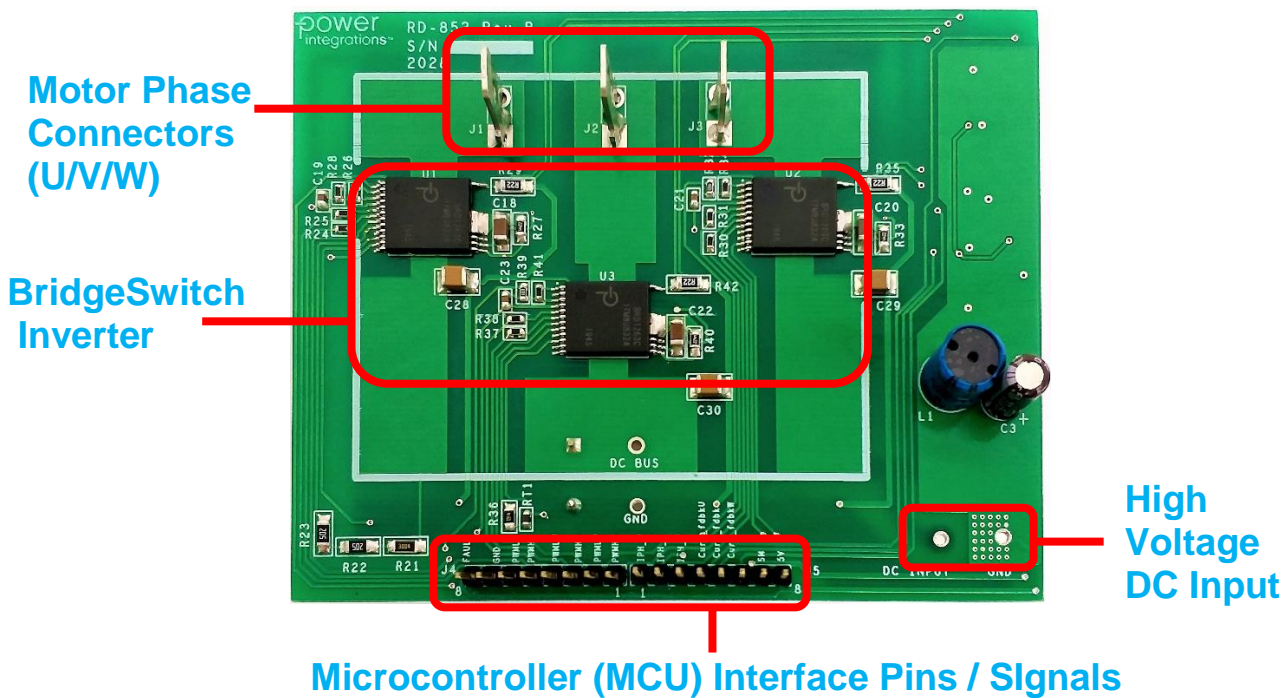

Figure 68 – RD-852 Board Quick Reference /Guide.

#### 8.1.1 The Microcontroller (MCU) Interface Contains the Following Pins / Signals

- **FAULT\_BUS** – Pin dedicated for fault reporting of all BridgeSwitch devices.
- **GND** – Common ground interface between the microcontroller and the inverter board.
- **PWMH\_U, PWML\_U, PWMH\_V, PWML\_V, PWMH\_W, and PWML\_W** – PWM input signal interface from the system microcontroller to the BridgeSwitch device.
- **+5 V** – Voltage supply pin for microcontroller as needed.
- **SM** – Configurable system monitoring pin for BridgeSwitch IC (U2).
- **Curr\_fdbkU, Curr\_fdbkV, Curr\_fdbkW** – Current feedback information needed by the microcontroller (MCU). This signal directly comes from the inverter current sense resistor passing through the current sense amplifier circuit.
- **IPH\_U, IPH\_V, IPH\_W** – Instantaneous phase current information of the low-side power FREDFET Drain to Source current of each BridgeSwitch device coming from the IPH pin.

**Note:** On the RD board, proper labels for the pin designations of connectors are provided.

## 8.1.2 J4 Connector Pin Designation

Pin No.	Signal	Type	Comments
1	PWML_V	Input	Gate drive signal for low-side power FREDFET phase V.
2	PWMH_V	Input	Gate drive signal for high-side power FREDFET phase V.
3	PWML_W	Input	Gate drive signal for low-side power FREDFET phase W.
4	PWMH_W	Input	Gate drive signal for high-side power FREDFET phase W.
5	PWML_U	Input	Gate drive signal for low-side power FREDFET phase U.
6	PWMH_U	Input	Gate drive signal for high-side power FREDFET phase U.
7	GND	n/a	Ground reference for connector input and output signals.
8	FAULT_BUS	Input/Output	Single wire, bi-directional fault communication bus.

## 8.1.3 J5 Connector Pin Designation

Pin No.	Signal	Type	Comments
1	IPH_U	Output	Voltage signal proportional to instantaneous phase low-side FREDFET Drain current of Phase U.
2	IPH_V	Output	Voltage signal proportional to instantaneous phase low-side FREDFET Drain current of Phase V.
3	IPH_W	Output	Voltage signal proportional to instantaneous phase low-side FREDFET Drain current of Phase W.
4	Curr_fdbkU	Output	Current feedback information needed by the microcontroller for phase U.
5	Curr_fdbkV	Output	Current feedback information needed by the microcontroller for phase V.
6	Curr_fdbkW	Output	Current feedback information needed by the microcontroller for phase W.
7	SM_W	Input	External input for system sensing (i.e. can be connected to external thermistor for system temperature monitor via status communication bus)
8	+5 V	Output	Voltage supply pin for microcontroller as needed

**Note:** On the RD board, proper labels for the pin designations of connectors are provided.

## 8.2 Recommended Start-up Sequence

BridgeSwitch devices have internal self-supply supporting commutation PWM frequencies up to 20 kHz. To ensure sufficient supply voltage levels across the BPL pin capacitor and the BPH pin capacitor at inverter start-up, the system micro-controller (MCU) should follow the recommended power-up sequence as depicted below.

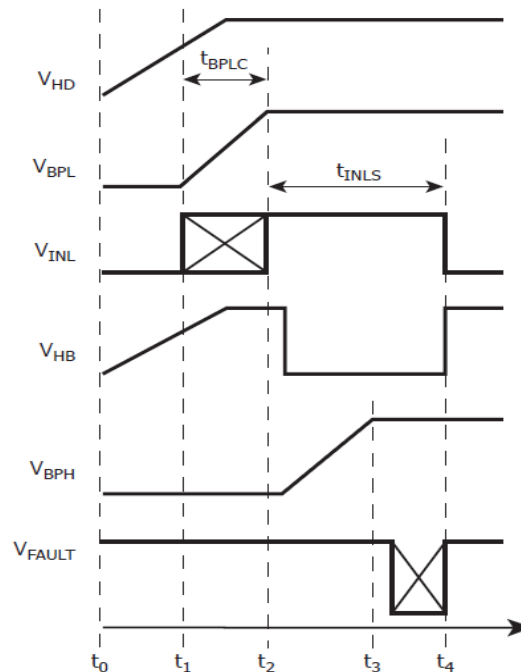

**Figure 69** – Recommended Power-up Sequence with Self-Supplied Operation.

The table below lists activities occurring during the recommended power-up sequence.

Time Point	Activity
$t_0$	<ul style="list-style-type: none"> <li>High-voltage DC bus is applied</li> </ul>
$t_1$	<ul style="list-style-type: none"> <li>Internal current source starts charging BPL pin capacitor once HD pin voltage reaches <math>V_{HD(START)}</math></li> <li>System MCU may start setting low-side power-FREDFET control signal INL to high</li> </ul>
$t_2$	<ul style="list-style-type: none"> <li>BPL pin voltage reaches <math>V_{BPL}</math> (typ. 14.5 V)</li> <li>Device determines external device settings</li> <li>Internal Gate drive logic turns on low-side power FREDFET after device setup completes and once INL becomes high or if it is high already</li> <li>Internal current source charges BPH pin capacitor</li> </ul>
$t_3$	<ul style="list-style-type: none"> <li>BPH pin voltage reaches <math>V_{BPH}</math> with respect to HB pin (typically 14.5 V)</li> <li>Device starts communicating successful power-up through fault pin</li> <li>Note: The device does not send a status update if the internal power-up sequence did not complete successfully</li> </ul>
$t_4$	<ul style="list-style-type: none"> <li>BridgeSwitch is ready for state operation (indicated by communicated status update at time point <math>t_3</math>)</li> <li>System MCU turns off low-side FREDFET</li> </ul>

**Table 4** – Power-up Sequence with Self-Supplied Operation.

8.3 **Status Word Encoding**

FAULT	Bit 0	Bit 1	Bit 2	Bit 3	Bit 4	Bit 5	Bit 6
HV Bus OV	0	0	1				
HV Bus UV 100%	0	1	0				
HV Bus UV 85%	0	1	1				
HV Bus UV 70%	1	0	0				
HV Bus UV 55%	1	0	1				
System Thermal Fault	1	1	0				
LS Driver Not Ready <sup>[1]</sup>	1	1	1				
LS FET Thermal Warning				0	1		
LS FET Thermal Shutdown				1	0		
HS Driver Not Ready <sup>[2]</sup>				1	1		
LS FET Over-Current						1	
HS FET Over-Current							
Device Ready (No Faults)	0	0	0	0	0	0	0

**Notes:**

1. Includes XL pin open/short-circuit fault, IPH pin to XL pin short-circuit, and trim bit corruption
2. Includes HS-to-LS communication loss, V<sub>BPH</sub> or internal 5 V rail out of range, and XH pin open/short-circuit fault

**Table 5** – BridgeSwitch Fault Encoding.

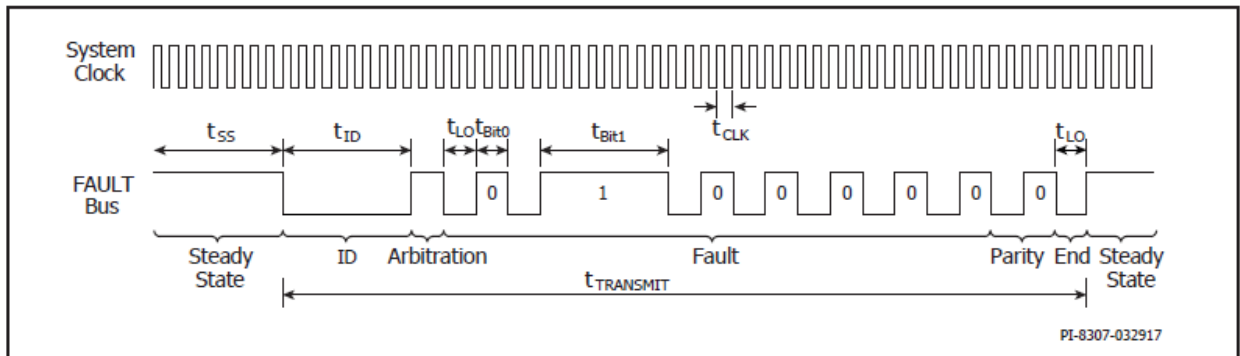

**Figure 70** – Fault Status Communication Bit Stream.



#### 8.4 ***Suggested Microcontroller Action/Decision To BridgeSwitch Fault Conditions***

<b>Fault</b>	<b>Fault ID</b>	<b>Action/Decision</b>
HV Bus Overvoltage	001xxxx	Shutdown
HV 100%	010xxxx	Warning
HV Bus 85%	011xxxx	Warning
HV Bus 70%	100xxxx	Warning
HV Bus 55%	101xxxx	Warning
System Thermal	110xxxx	Shutdown
LS Driver Not Ready	111xxxx	Shutdown
LS FET Thermal Warning	xxx010x	Warning
LS FET Thermal Shutdown	xxx10xx	Shutdown
LS FET Over-Current	xxxxx1x	Shutdown
HS Driver Not Ready	xxx11xx	Shutdown
HS FET Over-Current	xxxxxx1	Shutdown
Device Ready	0000000	None

### 8.5 *Inverter Output Power Measurement*

The 3-phase inverter output power ( $P_{OUT}$ ) measurement uses the “two wattmeter” method as illustrated below.

$$P_{OUT} = P_{CH1} + P_{CH2}$$

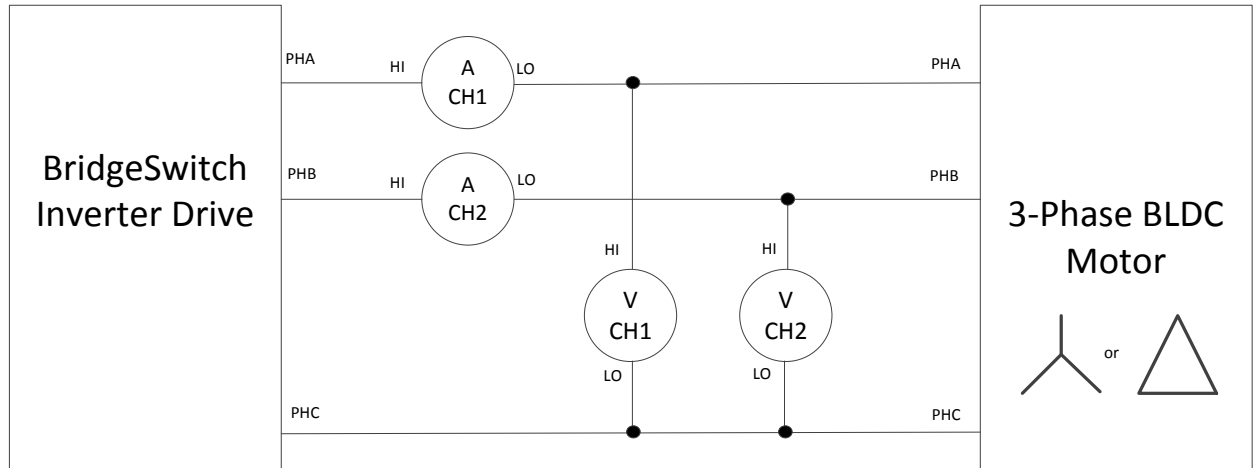

**Figure 71** – Inverter Output Power Measurement.

### 8.6 *Current Capability vs. Ambient Temperature*

The figure below depicts the continuous RMS current capability of the RDR-852 example design under different operating conditions: 5 kHz, 10 kHz and 15 kHz PWM frequency and the three BRD1263C devices operating self-supplied or with external supply at their respective BPL and BPH pins. The DC bus voltage is 340 VDC and the motor is operating at a speed of 5000 RPM. Each curve details the available continuous RMS current at different board ambient temperatures with a package temperature of 100 °C (average of all three devices).

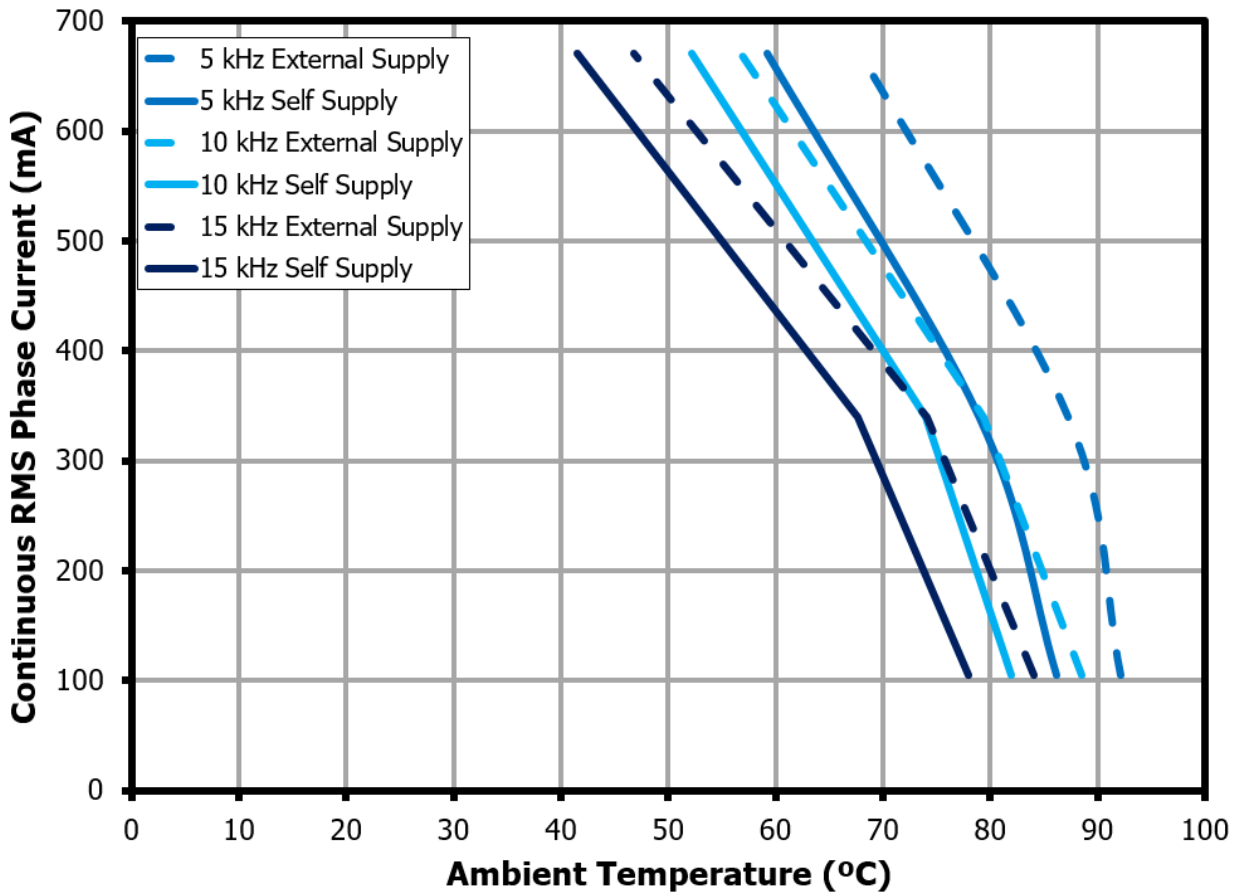
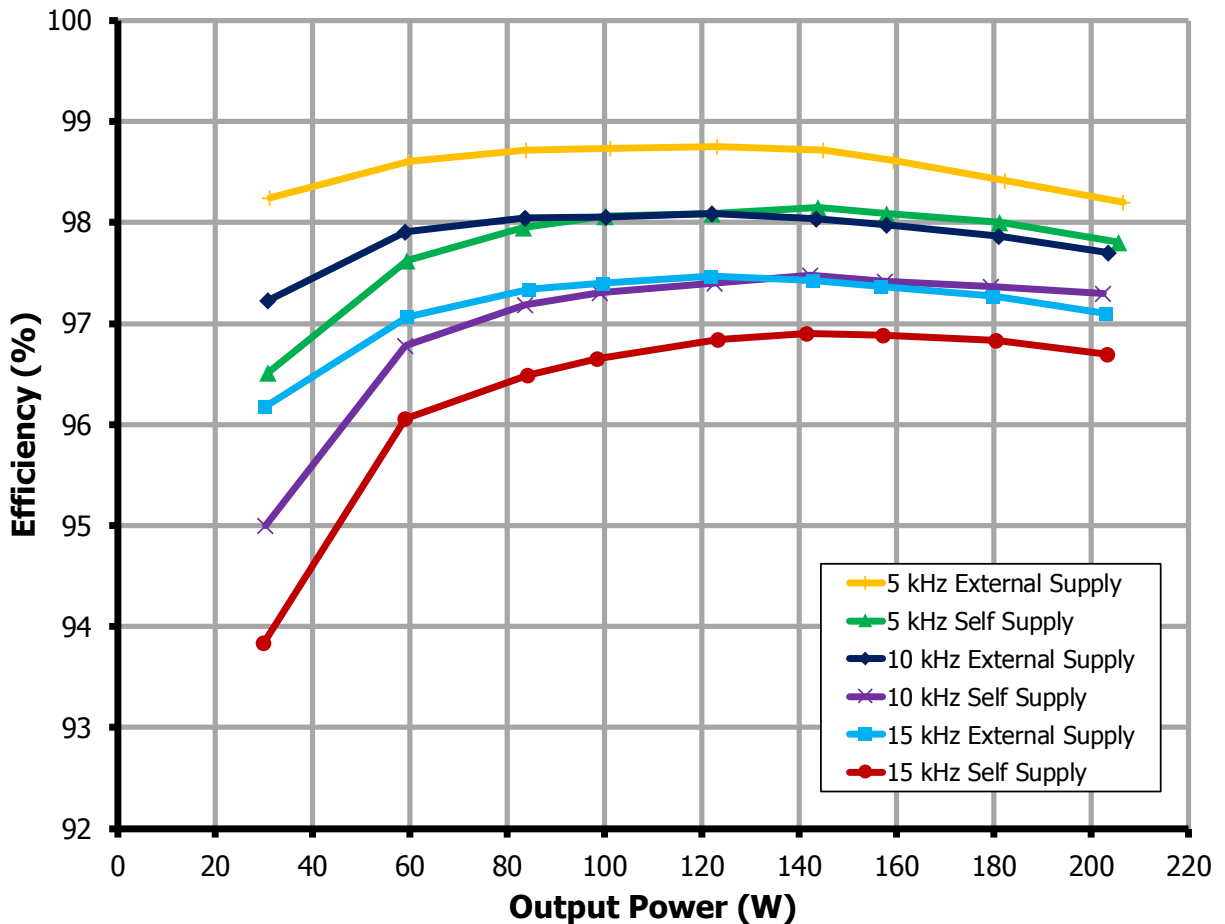

**Figure 72** – Current Capability vs. Ambient Temperature (Max. 100 °C Package Temperature).



**8.7 Efficiency Curve at Different Switching Frequencies**

The graph and table below shows the BridgeSwitch inverter efficiency at 340 VDC input, 5 kHz, 10 kHz, 15 kHz PWM switching frequencies, a constant motor speed of 5000 RPM, 3-phase FOC modulation, BridgeSwitch devices at self and external supply mode, and at room ambient temperature. The auxiliary circuit, +5 V linear regulator, input diode and current sense amplifier were disabled for efficiency data accuracy. This was accomplished by measuring the input voltage directly at the positive input DC BUS of the inverter, and depopulating components U4, U5, and D6. An external +5 VDC supply was provided between pins +5 V and GND for the microcontroller and current sense amplifier. An additional +17 VDC supply was used during external supply mode.



**Figure 73** – Inverter Efficiency Graph.



## 8.8 Test Bench Set-up

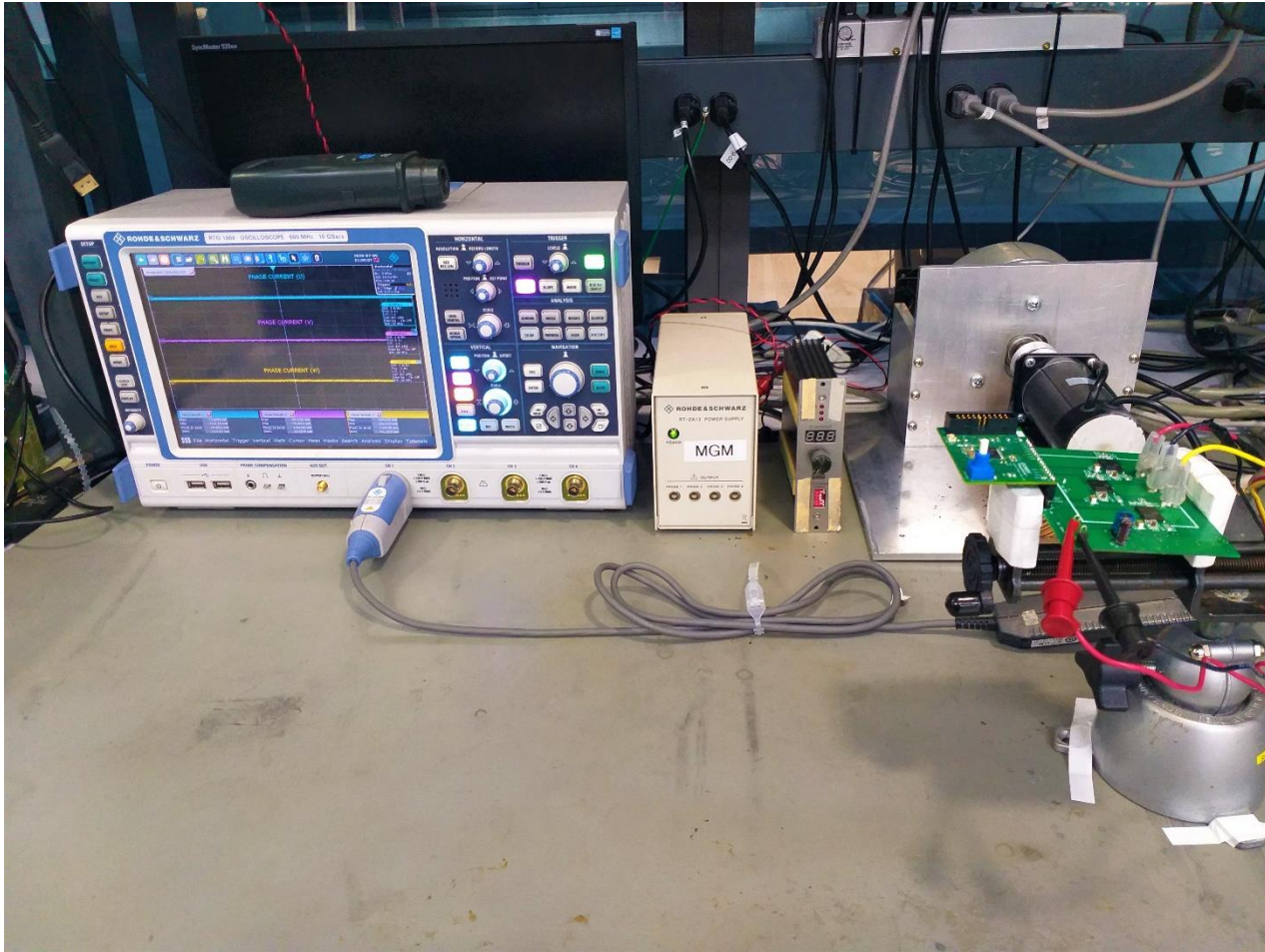

**Figure 74** – Actual Bench Set-up.

### EQUIPMENT USED:

1. **Motor** – 300 W, 5000 RPM, Model: 57BL110S30-3150TF0
2. **Motor brake load** – 24 VDC, 300 W motor brake load, Model: HB-503B by China-Tension
3. **Brake load control** – 24 VDC, 500 mA brake load control, Model: ICS-500 by China-Tension
4. **Coupler** – 8 mm X 17 mm motor coupler
5. **High-voltage DC source** – Agilent 6812B, used for supplying 340 VDC to the 3-phase inverter
6. **Low-voltage DC source** – Technique QT3005D-3 power supply, used for supplying 24 VDC for brake load control.

## 9 Revision History

<b>Date</b>	<b>Author</b>	<b>Rev.</b>	<b>Description &amp; Changes</b>	<b>Approval</b>
04-Feb-20	MQC	1.0	Initial Release.	Apps & Mktg
27-Jul-20	SM	1.1	Schematic, PCB, and Various Updates.	Apps & Mktg



**For the latest updates, visit our website: [www.power.com](http://www.power.com)**

Reference Designs are technical proposals concerning how to use Power Integrations' gate drivers in particular applications and/or with certain power modules. These proposals are "as is" and are not subject to any qualification process. The suitability, implementation and qualification are the sole responsibility of the end user. The statements, technical information and recommendations contained herein are believed to be accurate as of the date hereof. All parameters, numbers, values and other technical data included in the technical information were calculated and determined to our best knowledge in accordance with the relevant technical norms (if any). They may be based on assumptions or operational conditions that do not necessarily apply in general. We exclude any representation or warranty, express or implied, in relation to the accuracy or completeness of the statements, technical information and recommendations contained herein. No responsibility is accepted for the accuracy or sufficiency of any of the statements, technical information, recommendations or opinions communicated and any liability for any direct, indirect or consequential loss or damage suffered by any person arising therefrom is expressly disclaimed.

Power Integrations reserves the right to make changes to its products at any time to improve reliability or manufacturability. Power Integrations does not assume any liability arising from the use of any device or circuit described herein. POWER INTEGRATIONS MAKES NO WARRANTY HEREIN AND SPECIFICALLY DISCLAIMS ALL WARRANTIES INCLUDING, WITHOUT LIMITATION, THE IMPLIED WARRANTIES OF MERCHANTABILITY, FITNESS FOR A PARTICULAR PURPOSE, AND NON-INFRINGEMENT OF THIRD PARTY RIGHTS.

**Patent Information**

The products and applications illustrated herein (including transformer construction and circuits' external to the products) may be covered by one or more U.S. and foreign patents, or potentially by pending U.S. and foreign patent applications assigned to Power Integrations. A complete list of Power Integrations' patents may be found at [www.power.com](http://www.power.com). Power Integrations grants its customers a license under certain patent rights as set forth at <http://www.power.com/ip.htm>.

Power Integrations, the Power Integrations logo, CAPZero, ChiPhy, CHY, DPA-Switch, EcoSmart, E-Shield, eSIP, eSOP, HiperPLC, HiperPFS, HiperTFS, InnoSwitch, Innovation in Power Conversion, InSOP, LinkSwitch, LinkZero, LYTSwitch, SENZero, TinySwitch, TOPSwitch, PI, PI Expert, PowiGaN, SCALE, SCALE-1, SCALE-2, SCALE-3 and SCALE-iDriver, are trademarks of Power Integrations, Inc. Other trademarks are property of their respective companies. ©2019, Power Integrations, Inc.

**Power Integrations Worldwide Sales Support Locations****WORLD HEADQUARTERS**

5245 Hellyer Avenue  
San Jose, CA 95138, USA.  
Main: +1-408-414-9200  
Customer Service:  
Worldwide: +1-65-635-64480  
Americas: +1-408-414-9621  
e-mail: [usasales@power.com](mailto:usasales@power.com)

**CHINA (SHANGHAI)**

Rm 2410, Charity Plaza, No. 88,  
North Caoxi Road,  
Shanghai, PRC 200030  
Phone: +86-21-6354-6323  
e-mail: [chinasales@power.com](mailto:chinasales@power.com)

**CHINA (SHENZHEN)**

17/F, Hivac Building, No. 2, Keji  
Nan 8th Road, Nanshan District,  
Shenzhen, China, 518057  
Phone: +86-755-8672-8689  
e-mail: [chinasales@power.com](mailto:chinasales@power.com)

**GERMANY (AC-DC/LED Sales)**

Einsteinring 24  
85609 Dornach/Aschheim  
Germany  
Tel: +49-89-5527-39100  
e-mail: [eurosales@power.com](mailto:eurosales@power.com)

**GERMANY (Gate Driver Sales)**

HellwegForum 1  
59469 Ense  
Germany  
Tel: +49-2938-64-39990  
e-mail: [igbt-driver.sales@power.com](mailto:igbt-driver.sales@power.com)

**INDIA**

#1, 14<sup>th</sup> Main Road  
Vasanthanagar  
Bangalore-560052  
India  
Phone: +91-80-4113-8020  
e-mail: [indiasales@power.com](mailto:indiasales@power.com)

**ITALY**

Via Milanese 20, 3<sup>rd</sup>. Fl.  
20099 Sesto San Giovanni (MI) Italy  
Phone: +39-024-550-8701  
e-mail: [eurosales@power.com](mailto:eurosales@power.com)

**JAPAN**

Yusen Shin-Yokohama 1-chome  
Bldg.  
1-7-9, Shin-Yokohama, Kohoku-ku  
Yokohama-shi,  
Kanagawa 222-0033 Japan  
Phone: +81-45-471-1021  
e-mail: [japansales@power.com](mailto:japansales@power.com)

**KOREA**

RM 602, 6FL  
Korea City Air Terminal B/D,  
159-6  
Samsung-Dong, Kangnam-Gu,  
Seoul, 135-728 Korea  
Phone: +82-2-2016-6610  
e-mail: [koreasales@power.com](mailto:koreasales@power.com)

**SINGAPORE**

51 Newton Road,  
#19-01/05 Goldhill Plaza  
Singapore, 308900  
Phone: +65-6358-2160  
e-mail: [singaporesales@power.com](mailto:singaporesales@power.com)

**TAIWAN**

5F, No. 318, Nei Hu Rd.,  
Sec. 1  
Nei Hu District  
Taipei 11493, Taiwan R.O.C.  
Phone: +886-2-2659-4570  
e-mail: [taiwansales@power.com](mailto:taiwansales@power.com)

**UK**

Building 5, Suite 21  
The Westbrook Centre  
Milton Road  
Cambridge  
CB4 1YG  
Phone: +44 (0) 7823-557484  
e-mail: [eurosales@power.com](mailto:eurosales@power.com)

