

## Features

### Printed circuit mount 10 A relay

- New smaller size
- 1 Pole changeover contacts
- Miniature - "Sugar cube" package
- DC coil - 360 mW
- Wash tight: RT III
- Cadmium Free contact material
- RoHS conform

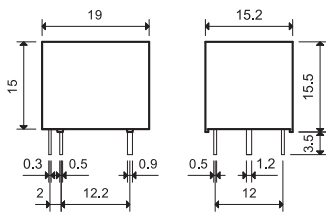

### 36.11-4011



- 1 CO (SPDT), 10 A
- Sugar cube size
- PCB mount

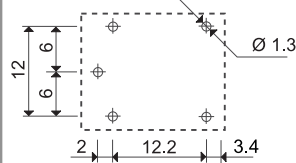
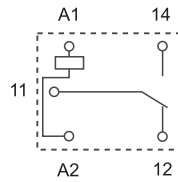

Copper side view

Contact specification		
Contact configuration		1 CO (SPDT)
Rated current/Maximum peak current	A	10/15
Rated voltage/Maximum switching voltage V AC		250/250
Rated load AC1	VA	2,500
Rated load AC15 (230 V AC)	VA	500
Single phase motor rating (230 V AC)	kW	0.37
Breaking capacity DC1: 30/110/220 V	A	10/0.3/0.12
Minimum switching load	mW (V/mA)	300 (6/1,000)
Standard contact material		AgSnO <sub>2</sub>
Coil specification		
Nominal voltage (U <sub>N</sub> )	V AC (50/60 Hz)	—
	V DC	3 - 5 - 6 - 9 - 12 - 18 - 24 - 48
Rated power AC/DC	VA (50 Hz)/W	—/0.36
Operating range	AC	—
	DC	(0.75...1.3)U <sub>N</sub>
Holding voltage	AC/DC	—/0.4 U <sub>N</sub>
Must drop-out voltage	AC/DC	—/0.1 U <sub>N</sub>
Technical data		
Mechanical life AC/DC	cycles	—/10 · 10 <sup>6</sup>
Electrical life at rated load AC1	cycles	50 · 10 <sup>3</sup>
Operate/release time	ms	10/5
Insulation between coil and contacts (1.2/50 μs)	kV	3
Dielectric strength between open contacts V AC		750
Ambient temperature range	°C	—40...+85
Environmental protection		RT III
<b>Approvals</b> (according to type)		

## Ordering information

Example: 36 series miniature PCB relay, 1 CO (SPDT) - 10 A contacts, 12 V DC coil.

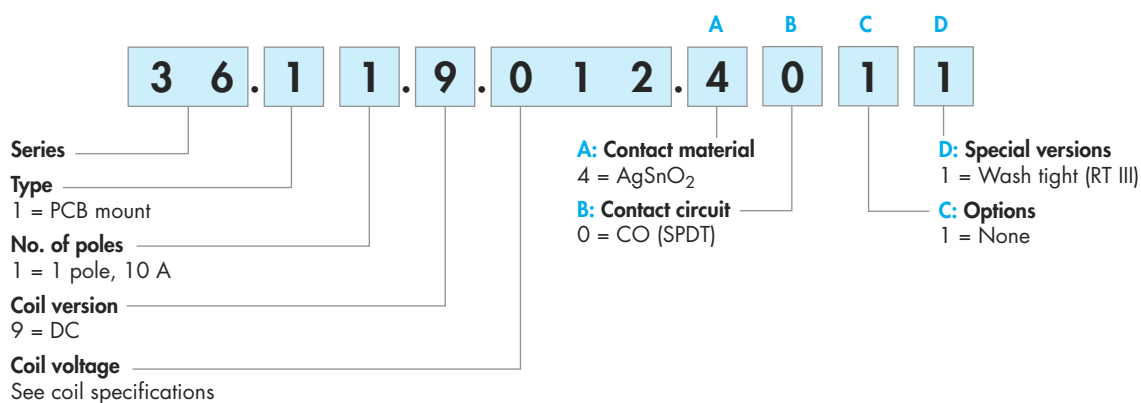

**Selecting features and options: only combinations in the same row are possible.**  
Preferred selections for best availability are shown in **bold**.

Type	Coil version	A	B	C	D
36.11	DC	<b>4</b>	<b>0</b>	<b>1</b>	<b>1</b>

## Technical data

Insulation according to EN 61810-1		
Nominal voltage of supply system	V AC	230/400
Rated insulation voltage	V AC	250
Pollution degree		2
Insulation between coil and contact set		
Type of insulation		Basic
Overvoltage category		II
Rated impulse voltage	kV (1.2/50 μs)	3
Dielectric strength	V AC	2,500
Insulation between open contacts		
Type of disconnection		Micro-disconnection
Dielectric strength	V AC/kV (1.2/50 μs)	750/1.5
Other data		
Shock resistance	g	10
Recommended distance between relays mounted on PCB	mm	≥ 5

### Contact specification

F 36 - Electrical life (AC) v contact current

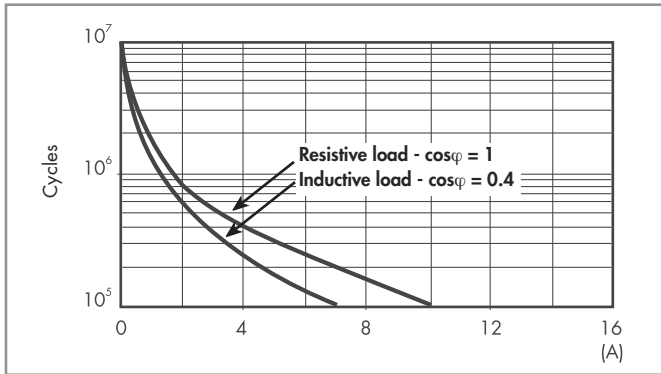

H 36 - Maximum DC1 breaking capacity

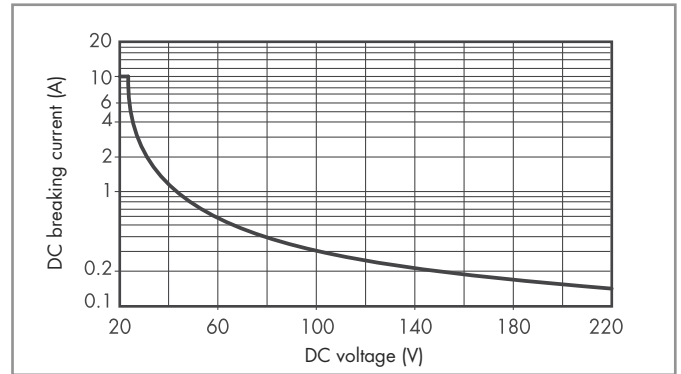

- When switching a resistive load (DC1) having voltage and current values under the curve, an electrical life of  $\geq 100 \cdot 10^3$  can be expected.
- In the case of DC13 loads, the connection of a diode in parallel with the load will permit a similar electrical life as for a DC1 load.  
Note: the release time for the load will be increased.

### Coil specifications

DC coil data

Nominal voltage $U_N$ V	Coil code	Operating range		Resistance R $\Omega$	Rated coil consumption I at $U_N$ mA
		$U_{min}$ V	$U_{max}$ V		
3	9.003	2.2	3.9	25	120
5	9.005	3.7	6.5	70	72
6	9.006	4.5	7.8	100	60
9	9.009	6.7	11.7	225	40
12	9.012	9	15.6	400	30
18	9.018	13.5	23.4	900	20
24	9.024	18	31.2	1,600	15
48	9.048	36	62.4	6,400	7.5

R 36 - DC coil operating range v ambient temperature

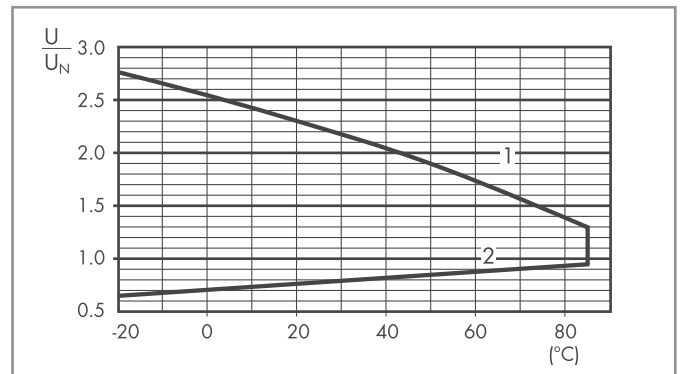

- 1 - Max. permitted coil voltage.
- 2 - Min. pick-up voltage with coil at ambient temperature.

