

Grub Screws • ball-headed

22570.0450

Product Description

The ball-headed grub screws (EH 22570.) can be combined with plastic thrust pads (EH 22570.).



Material

- Stainless steel 1.4305

More information

Further products

- Thrust Pads, plastic

Drawing

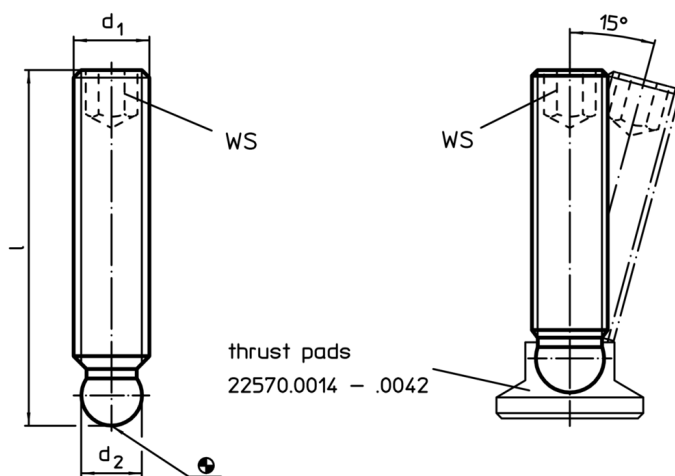

Order information

d ₁	Dimensions		WS	Art. No.
	l	d ₂ +0.05		
	[mm]		[mm]	[g]
stainless steel				
M10	50	7.8	5	22
				22570.0450

Application example

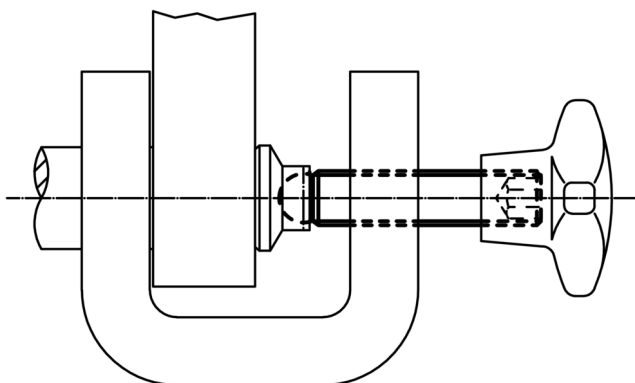

Compliance

RoHS compliant

Compliant according to Directive 2011/65/EU and Directive 2015/863

Does not contain SVHC substances

No SVHC substances with more than 0.1% w/w contained - SVHC list [REACH] as of 10.06.2022

Does not contain Proposition 65 substances

No Proposition 65 substances included
<https://www.P65Warnings.ca.gov/>

Free from Conflict Minerals

This product does not contain any substances designated as "conflict minerals" such as tantalum, tin, gold or tungsten from the Democratic Republic of Congo or adjacent countries.