

# High Voltage IGBTs w/Diode

# IXGH40N120B2D1 IXGT40N120B2D1

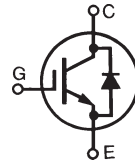

$V_{CES} = 1200V$   
 $I_{C110} = 40A$   
 $V_{CE(sat)} \leq 3.5V$   
 $t_{fi(typ)} = 140ns$

Symbol	Test Conditions	Maximum Ratings	
$V_{CES}$	$T_C = 25^\circ C$ to $150^\circ C$	1200	V
$V_{CGR}$	$T_J = 25^\circ C$ to $150^\circ C$ , $R_{GE} = 1M\Omega$	1200	V
$V_{GES}$	Continuous	$\pm 20$	V
$V_{GEM}$	Transient	$\pm 30$	V
$I_{C25}$	$T_C = 25^\circ C$ (Limited by Lead)	75	A
$I_{C110}$	$T_C = 110^\circ C$	40	A
$I_{F110}$	$T_C = 110^\circ C$	25	A
$I_{CM}$	$T_C = 25^\circ C$ , 1ms	200	A
<b>SSOA</b> <b>(RBSOA)</b>	$V_{GE} = 15V$ , $T_{VJ} = 125^\circ C$ , $R_G = 2\Omega$ Clamped Inductive Load	$I_{CM} = 80$ @ $0.8 \leq V_{CES}$	A V
$P_C$	$T_C = 25^\circ C$	380	W
$T_J$		-55 ... +150	$^\circ C$
$T_{JM}$		150	$^\circ C$
$T_{stg}$		-55 ... +150	$^\circ C$
$T_L$	1.6mm (0.062 in.) from Case for 10s	300	$^\circ C$
$T_{SOLD}$	Plastic Body for 10 seconds	260	$^\circ C$
$M_d$	Mounting Torque (TO-247)	1.13/10	Nm/lb.in.
<b>Weight</b>	TO-247	6	g
	TO-268	4	g

## TO-247 (IXGH)

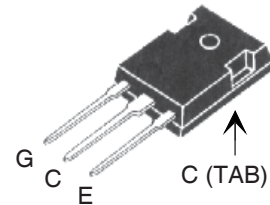

## TO-268 (IXGT)

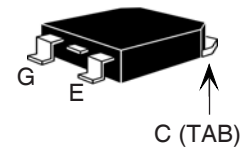

G = Gate      C = Collector  
 E = Emitter    TAB = Collector

## Features

- International Standard Packages
- IGBT and Anti-Parallel FRED for Resonant Power Supplies
  - Induction Heating
  - Rice Cookers
- Square RBSOA
- Fast Recovery Exipitaxial Diode (FRED)
  - Soft Recovery with Low  $I_{RM}$

## Advantages

- High Power Density
- Low Gate Drive Requirement

Symbol	Test Conditions ( $T_J = 25^\circ C$ Unless Otherwise Specified)	Characteristic Values		
		Min.	Typ.	Max.
$V_{GE(th)}$	$I_C = 250\mu A$ , $V_{CE} = V_{GE}$	3.0		5.0 V
$I_{CES}$	$V_{CE} = V_{CES}$ , $V_{GE} = 0V$			100 $\mu A$ 3 mA
			$T_J = 125^\circ C$	
$I_{GES}$	$V_{CE} = 0V$ , $V_{GE} = \pm 20V$			$\pm 100$ nA
$V_{CE(sat)}$	$I_C = 40A$ , $V_{GE} = 15V$ , Note 1		2.9	3.5 V

Symbol	Test Conditions	Characteristic Values		
		Min.	Typ.	Max.
$g_{fs}$	$I_C = 40A, V_{CE} = 10V, \text{Note 1}$	23	37	S
$C_{ies}$	$V_{CE} = 25V, V_{GE} = 0V, f = 1MHz$		3360	pF
$C_{oes}$			190	pF
$C_{res}$			63	pF
$Q_g$	$I_C = 40A, V_{GE} = 15V, V_{CE} = 0.5 \cdot V_{CES}$		138	nC
$Q_{ge}$			20	nC
$Q_{gc}$			48	nC
$t_{d(on)}$	<b>Inductive load, <math>T_J = 25^\circ C</math></b> $I_C = 40A, V_{GE} = 15V$ $V_{CE} = 960V, R_G = 2\Omega$ Note 2		21	ns
$t_{ri}$			55	ns
$E_{on}$			4.5	mJ
$t_{d(off)}$			290	ns
$t_{fi}$			140	270
$E_{off}$		3.0	6.0	mJ
$t_{d(on)}$	<b>Inductive load, <math>T_J = 125^\circ C</math></b> $I_C = 40A, V_{GE} = 15V$ $V_{CE} = 960V, R_G = 2\Omega$ Note 2		21	ns
$t_{ri}$			58	ns
$E_{on}$			6.5	mJ
$t_{d(off)}$			350	ns
$t_{fi}$			420	ns
$E_{off}$		8.3	mJ	
$R_{thJC}$			0.33	$^\circ C/W$
$R_{thCS}$		0.21		$^\circ C/W$

### Reverse Diode (FRED)

Symbol	Test Conditions	Characteristic Values		
		Min.	Typ.	Max.
$V_F$	$I_F = 30A, V_{GE} = 0V$			2.8 V
		$T_J = 150^\circ C$	1.6	V
$I_{RM}$	$I_F = 30A, -di/dt = 100A/\mu s,$ $V_R = 300V, V_{GE} = 0V$	$T_J = 100^\circ C$		4 A
$t_{rr}$		$T_J = 100^\circ C$	100	ns
$R_{thJC}$				0.9 $^\circ C/W$

Note 1: Pulse Test,  $t \leq 300\mu s$ , Duty Cycle,  $d \leq 2\%$ .  
 2. Switching Times may Increase for  $V_{CE} (\text{Clamp}) > 0.8 \cdot V_{CES}$ ,  
 Higher  $T_J$  or Increased  $R_G$ .

### TO-247 (IXGH) Outline

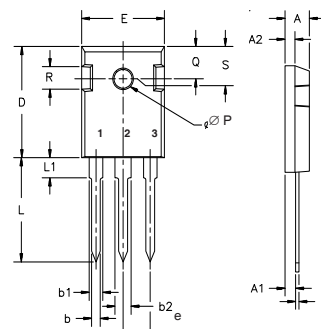

Terminals: 1 - Gate  
 2 - Drain  
 3 - Source  
 Tab - Drain

Dim.	Millimeter		Inches	
	Min.	Max.	Min.	Max.
A	4.7	5.3	.185	.209
A <sub>1</sub>	2.2	2.54	.087	.102
A <sub>2</sub>	2.2	2.6	.059	.098
b	1.0	1.4	.040	.055
b <sub>1</sub>	1.65	2.13	.065	.084
b <sub>2</sub>	2.87	3.12	.113	.123
C	.4	.8	.016	.031
D	20.80	21.46	.819	.845
E	15.75	16.26	.610	.640
e	5.20	5.72	0.205	0.225
L	19.81	20.32	.780	.800
L <sub>1</sub>		4.50		.177
∅P	3.55	3.65	.140	.144
Q	5.89	6.40	0.232	0.252
R	4.32	5.49	.170	.216
S	6.15	BSC	242	BSC

### TO-268 (IXGT) Outline

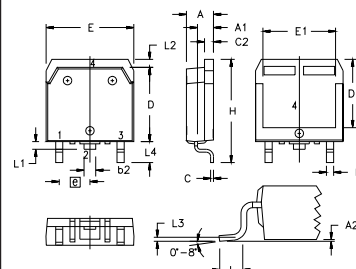

SYM	INCHES		MILLIMETERS	
	MIN	MAX	MIN	MAX
A	.193	.201	4.90	5.10
A <sub>1</sub>	.106	.114	2.70	2.90
A <sub>2</sub>	.001	.010	0.02	0.25
b	.045	.057	1.15	1.45
b <sub>2</sub>	.075	.083	1.90	2.10
C	.016	.026	0.40	0.65
C <sub>2</sub>	.057	.063	1.45	1.60
D	.543	.551	13.80	14.00
D <sub>1</sub>	.488	.500	12.40	12.70
E	.624	.632	15.85	16.05
E <sub>1</sub>	.524	.535	13.30	13.60
e	.215 BSC		5.45 BSC	
H	.736	.752	18.70	19.10
L	.094	.106	2.40	2.70
L <sub>1</sub>	.047	.055	1.20	1.40
L <sub>2</sub>	.039	.045	1.00	1.15
L <sub>3</sub>	.010 BSC		0.25 BSC	
L <sub>4</sub>	.150	.161	3.80	4.10

IXYS Reserves the Right to Change Limits, Test Conditions and Dimensions.

IXYS MOSFETs and IGBTs are covered by one or more of the following U.S. patents:

4,835,592	4,931,844	5,049,961	5,237,481	6,162,665	6,404,065 B1	6,683,344	6,727,585	7,005,734 B2	7,157,338B2
4,850,072	5,017,508	5,063,307	5,381,025	6,259,123 B1	6,534,343	6,710,405 B2	6,759,692	7,063,975 B2	
4,881,106	5,034,796	5,187,117	5,486,715	6,306,728 B1	6,583,505	6,710,463	6,771,478 B2	7,071,537	

**Fig. 1. Output Characteristics @ 25°C**

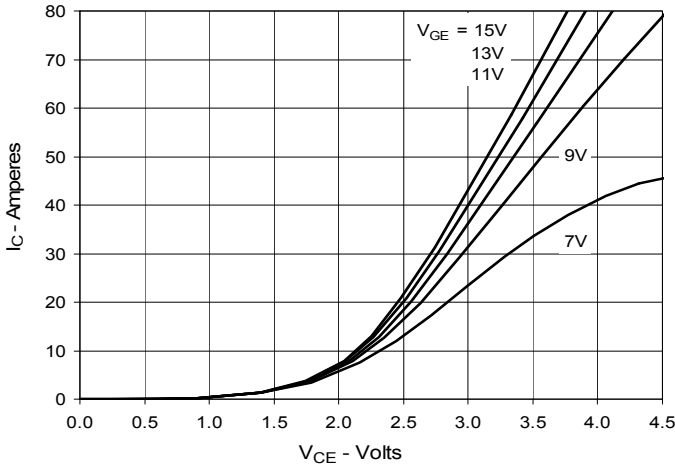

**Fig. 2. Extended Output Characteristics @ 25°C**

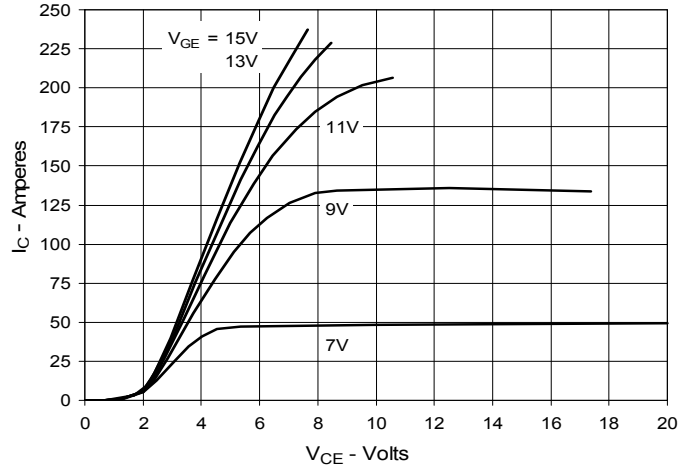

**Fig. 3. Output Characteristics @ 125°C**

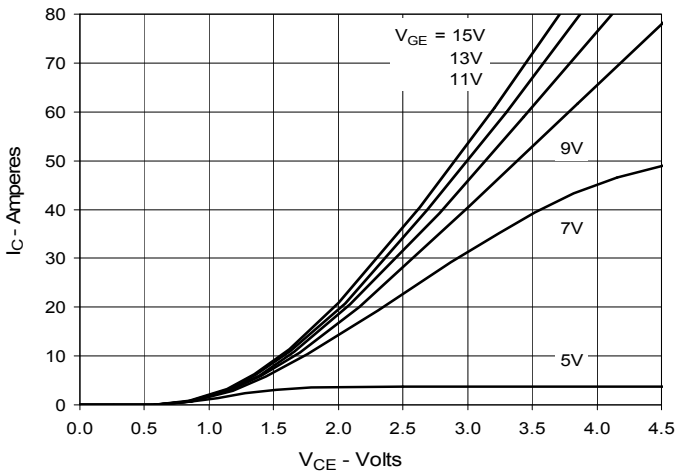

**Fig. 4. Dependence of  $V_{CE(sat)}$  on Junction Temperature**

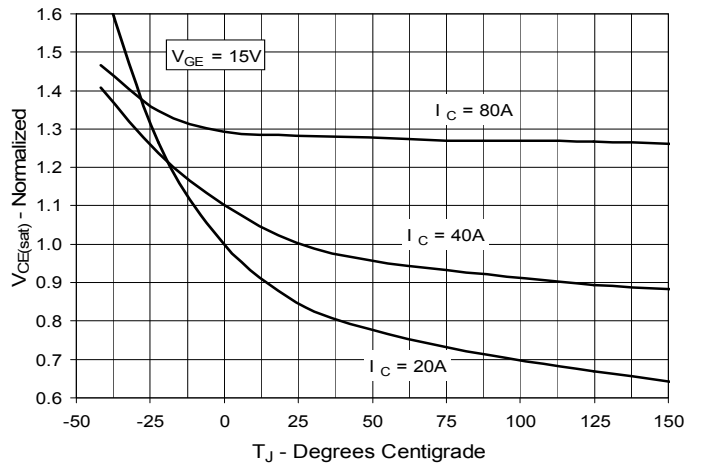

**Fig. 5. Collector-to-Emitter Voltage vs. Gate-to-Emitter Voltage**

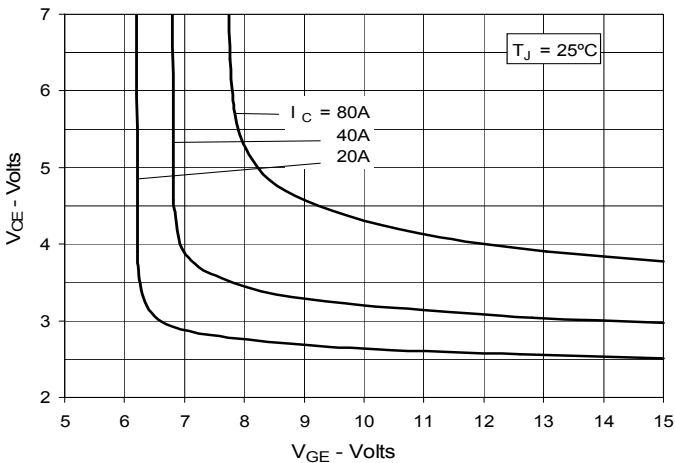

**Fig. 6. Input Admittance**

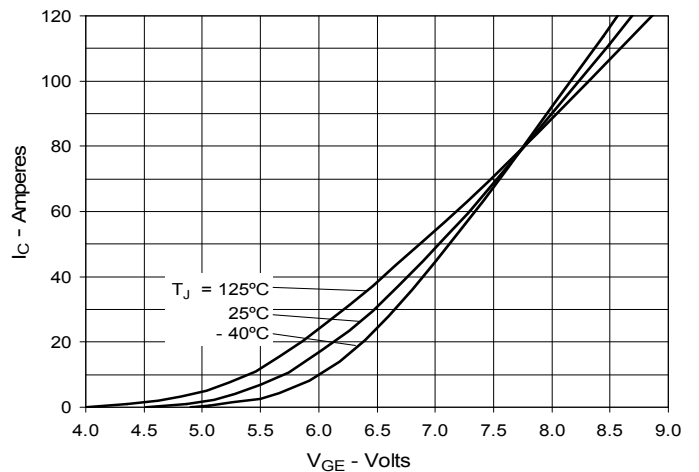

**Fig. 7. Transconductance**

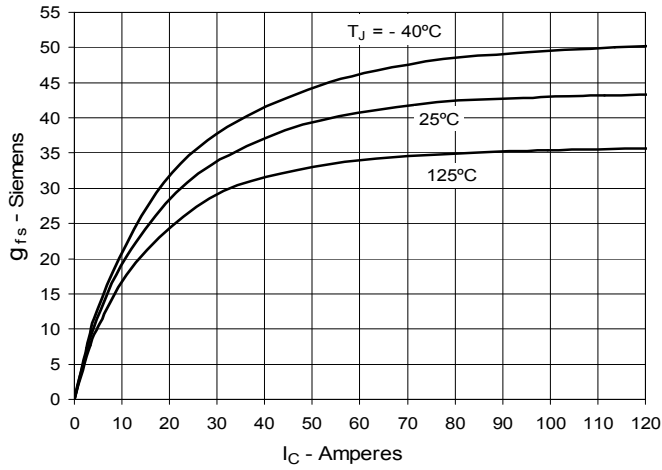

**Fig. 8. Gate Charge**

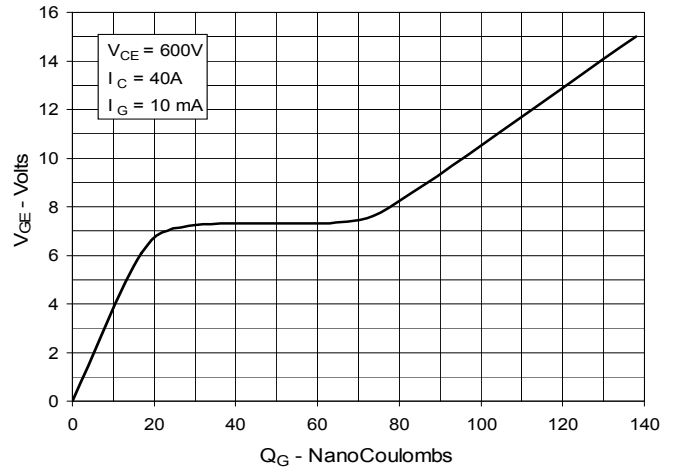

**Fig. 9. Capacitance**

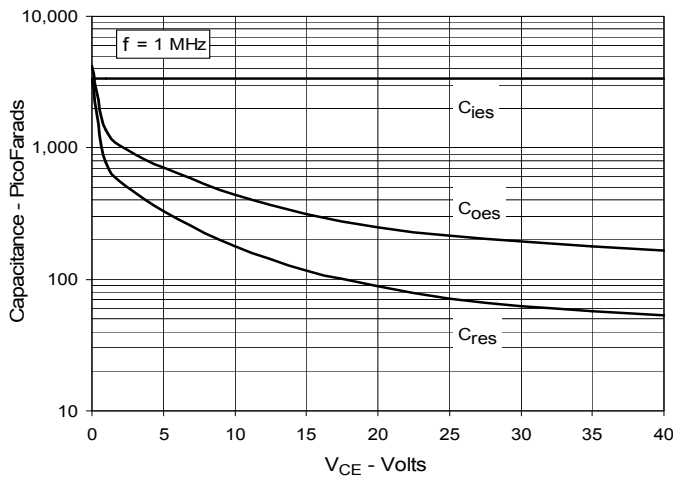

**Fig. 10. Reverse-Bias Safe Operating Area**

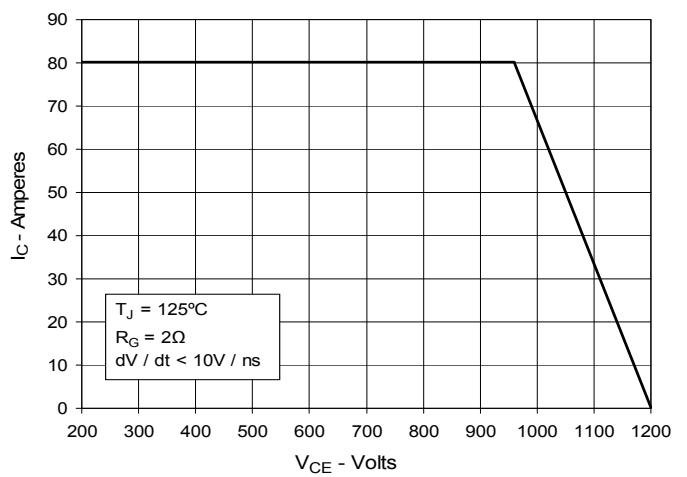

**Fig. 11. Maximum Transient Thermal Impedance**

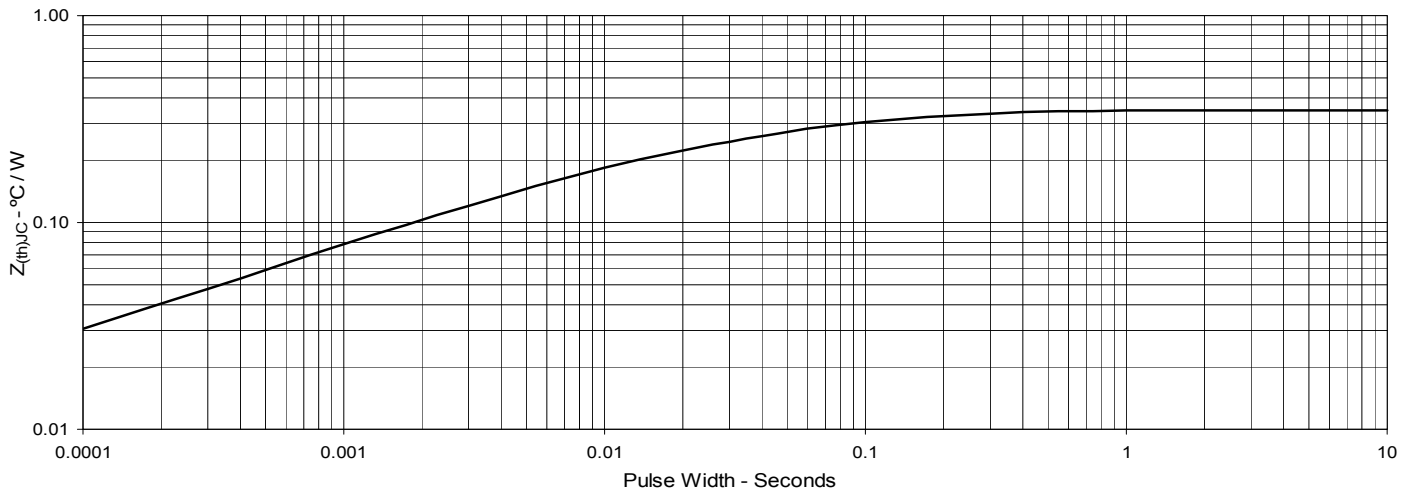

**Fig. 12. Inductive Switching Energy Loss vs. Gate Resistance**

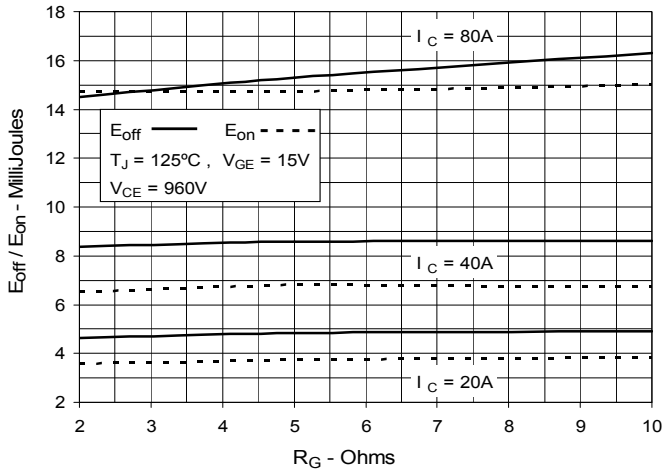

**Fig. 13. Inductive Switching Energy Loss vs. Junction Temperature**

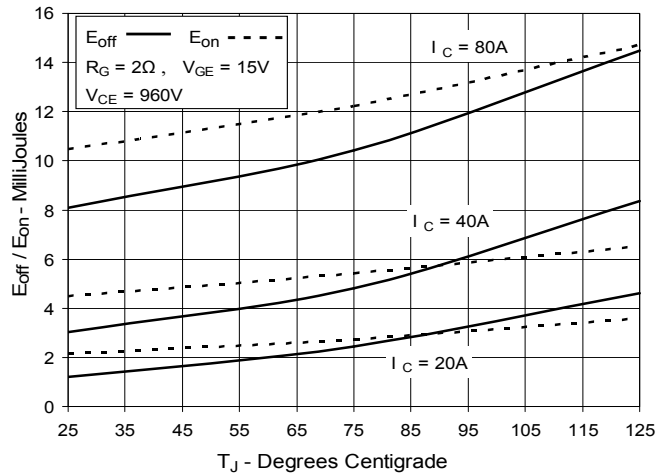

**Fig. 14. Inductive Switching Energy Loss vs. Collector Current**

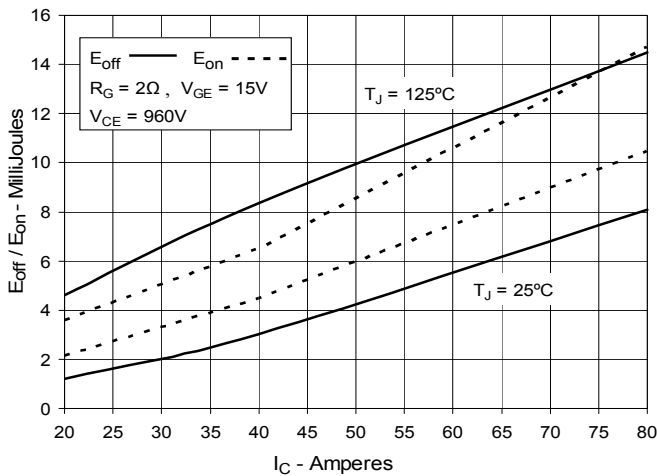

**Fig. 15. Inductive Turn-off Switching Times vs. Gate Resistance**

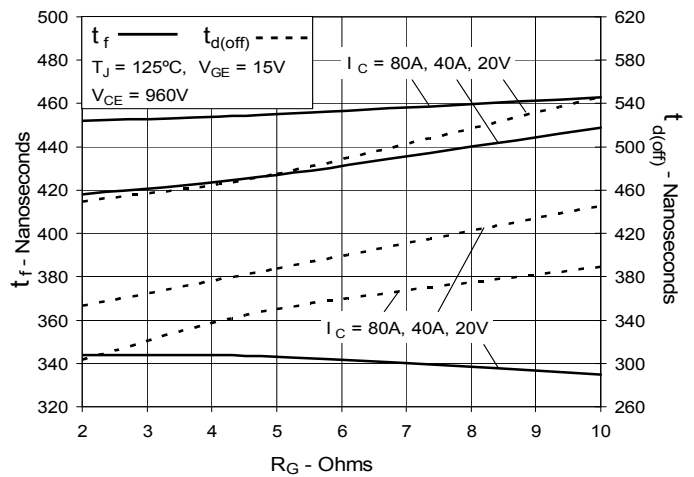

**Fig. 16. Inductive Turn-off Switching Times vs. Junction Temperature**

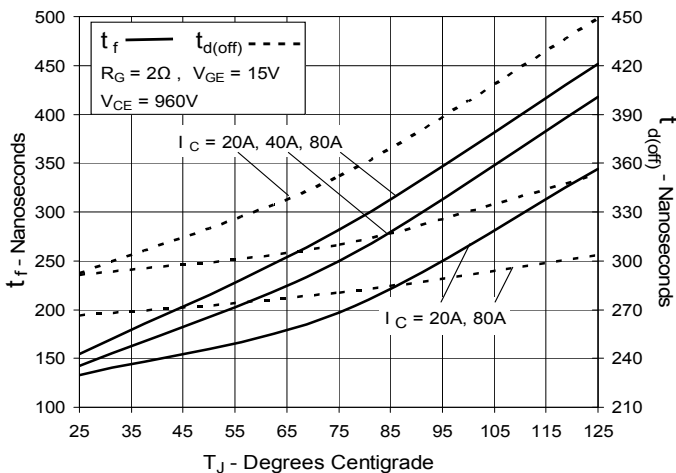

**Fig. 17. Inductive Turn-off Switching Times vs. Collector Current**

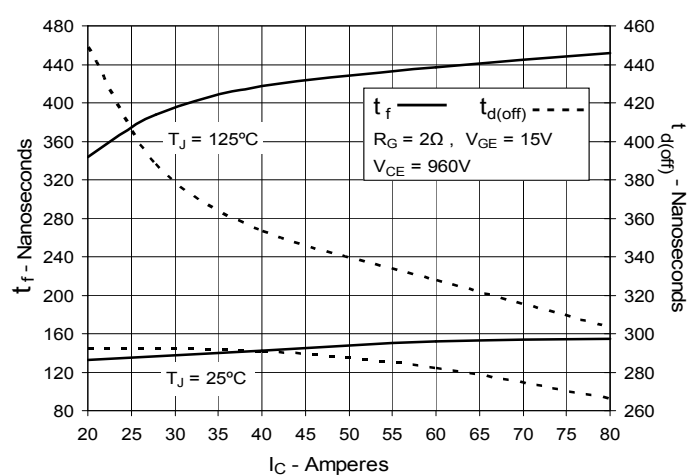

**Fig. 18. Inductive Turn-on Switching Times vs. Gate Resistance**

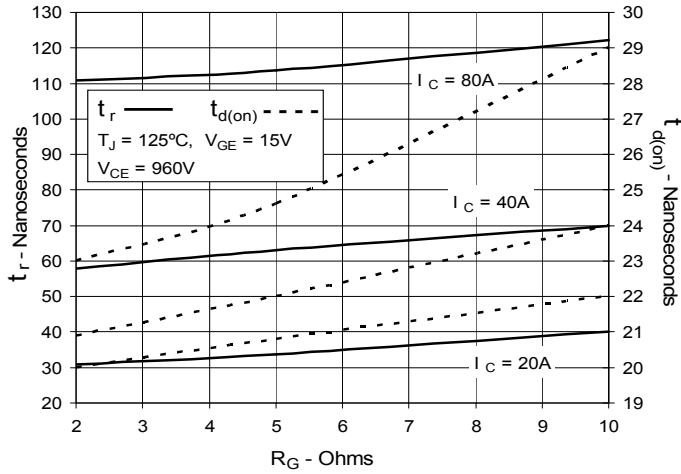

**Fig. 19. Inductive Turn-on Switching Times vs. Junction Temperature**

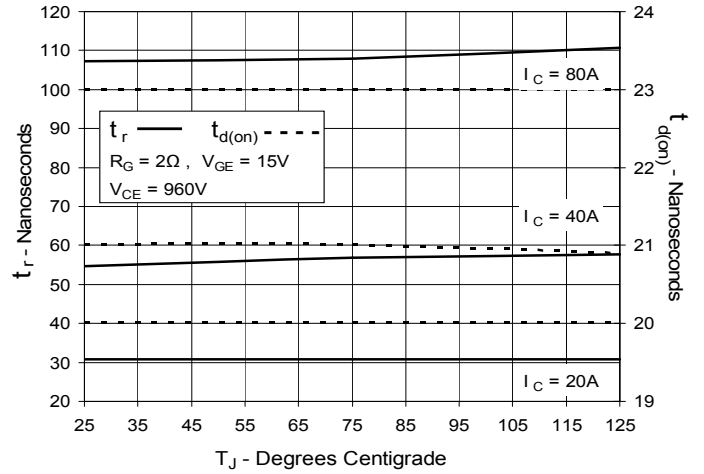

**Fig. 20. Inductive Turn-on Switching Times vs. Collector Current**

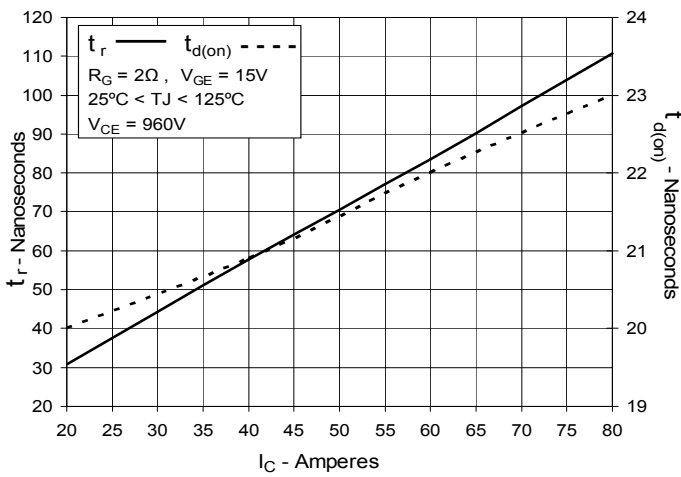

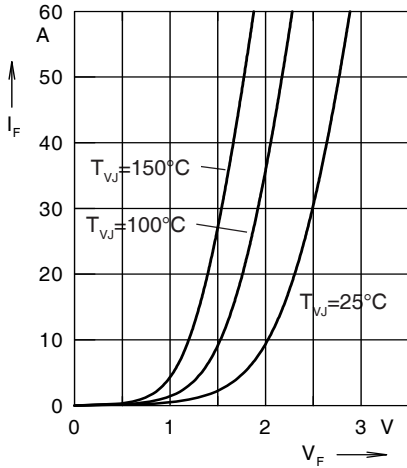

Fig. 21. Forward current  $I_F$  versus  $V_F$

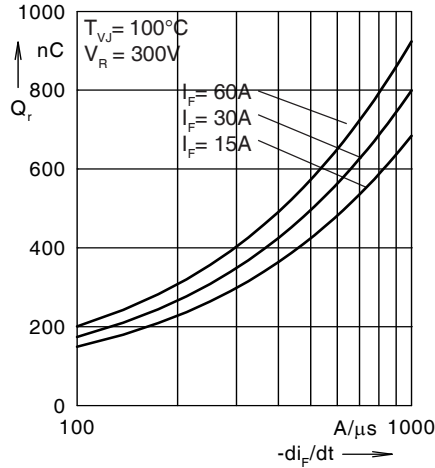

Fig. 22. Reverse recovery charge  $Q_r$  versus  $-di_F/dt$

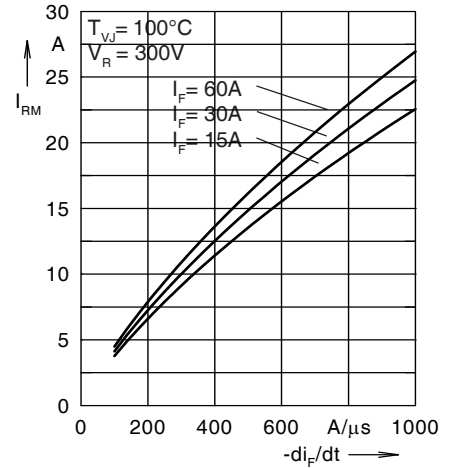

Fig. 23. Peak reverse current  $I_{RM}$  versus  $-di_F/dt$

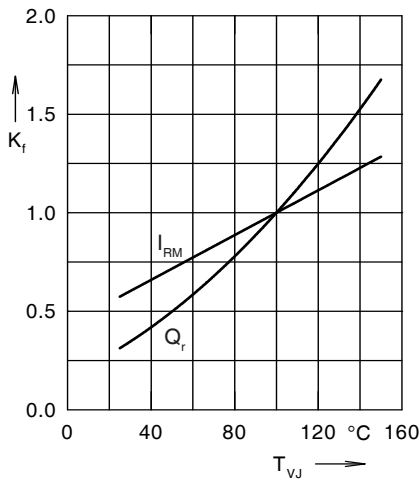

Fig. 24. Dynamic parameters  $Q_r$ ,  $I_{RM}$  versus  $T_{VJ}$

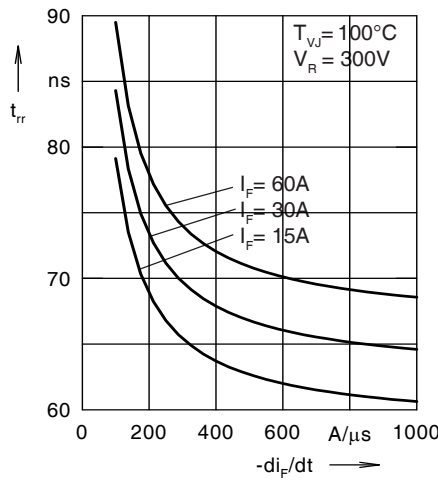

Fig. 25. Recovery time  $t_{rr}$  versus  $-di_F/dt$

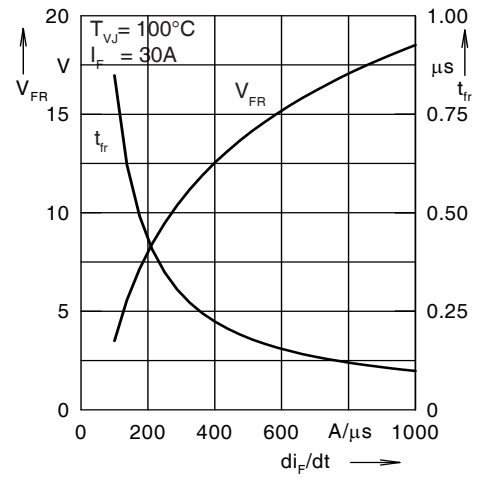

Fig. 26. Peak forward voltage  $V_{FR}$  and  $t_{fr}$  versus  $di_F/dt$

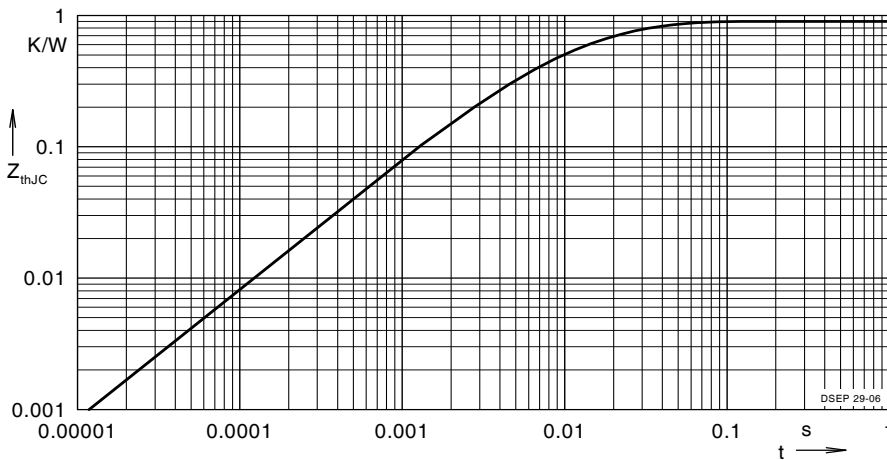

Fig. 27. Transient thermal resistance junction to case

### Constants for $Z_{thJC}$ calculation

i	$R_{th}$ (°C/W)	$t_i$ (s)
1	0.465	0.0052
2	0.179	0.0003
3	0.256	0.0397



---

Disclaimer Notice - Information furnished is believed to be accurate and reliable. However, users should independently evaluate the suitability of and test each product selected for their own applications. Littelfuse products are not designed for, and may not be used in, all applications. Read complete Disclaimer Notice at [www.littelfuse.com/disclaimer-electronics](http://www.littelfuse.com/disclaimer-electronics).