

SUPPLEMENTARY HANDLE FOR DOOR MOUNTED ROTARY OPERATOR STANDARD ACCESSORY FOR 3VA6 150/250

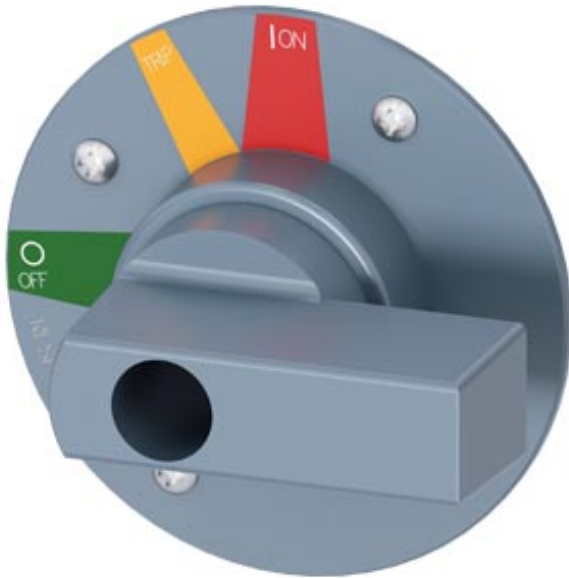

Model	
Product brand name	SETRON
Product designation	Accessories
Design of the product	Additional handle for door-coupling rotary operating mechanism
accessories	Additional handle for

Mechanical Design	
Height	70 mm
Width	70 mm
Depth	36 mm

Certificates			
General Product Approval	EMC	Declaration of Conformity	other



[Miscellaneous](#)

Further information

Information- and Downloadcenter (Catalogs, Brochures,...)

<http://www.siemens.com/lowvoltage/catalogs>

Industry Mall (Online ordering system)

<https://mall.industry.siemens.com/mall/en/en/Catalog/product?mlfb=3VA9477-0GC01>

Service&Support (Manuals, Certificates, Characteristics, FAQs,...)

<https://support.industry.siemens.com/cs/ww/en/ps/3VA9477-0GC01>

Image database (product images, 2D dimension drawings, 3D models, device circuit diagrams, ...)

http://www.automation.siemens.com/bilddb/cax_en.aspx?mlfb=3VA9477-0GC01

CAX-Online-Generator

<http://www.siemens.com/cax>

Tender specifications

<http://www.siemens.com/specifications>

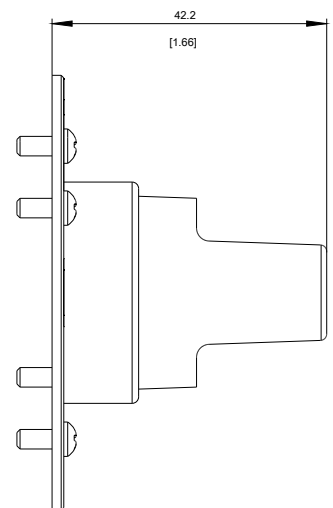
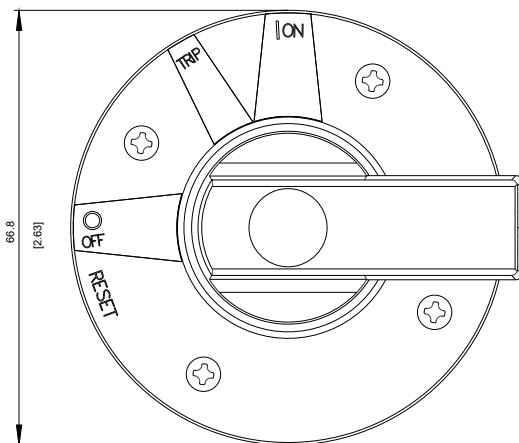

last modified:

08/29/2017