

Specification / Spezifikation

Model-No / Modell Nr.	RAH9225S1
Dimension / Abmessungen	92 x 92 x 25 mm
Rated Voltage / Nennspannung	230VAC
Operating Voltage / Arbeitsspannung	161 ~ 242 VAC
Frequency / Frequenz	50/60 Hz
Rated Current / Nennstrom	0,10A
Power / Leistung	13/11 W
Rotating Speed / Umdrehungen	1300/1700 rpm +/- 10%
Airflow / Luftdurchsatz	33,98/44,17 m ³ /h
Static Pressure / Statischer Druck	1,0/1,6 mm H ₂ O
Noise Level / Geräusch	20/23 dBA
Weight / Gewicht	240 g
Material	Frame/Gehäuse: Aluminium Impeller/Lüfterrad: Thermo Plastic
Bearing / Lager	Sleeve Bearing / Gleitlager
Connection / Anschluss	Terminals

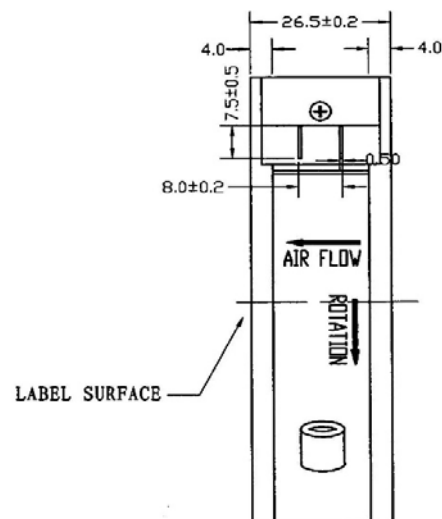

Safety Approvals / Prüfzeichen

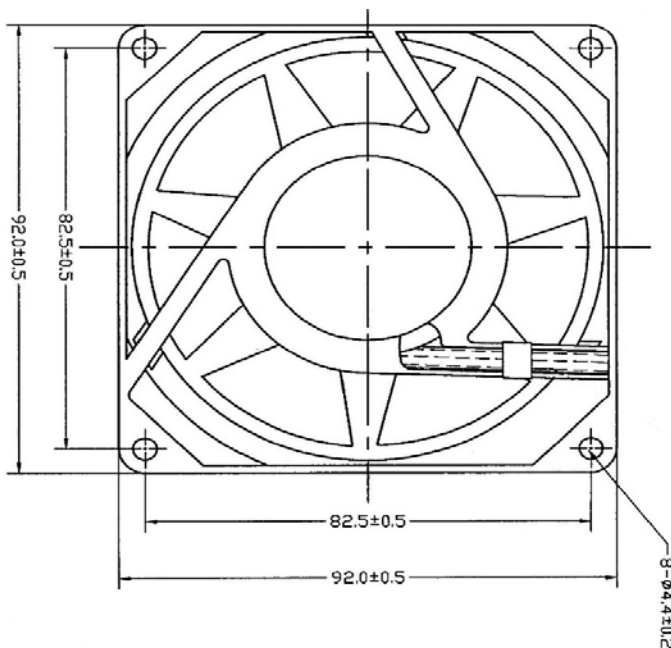

Irrtum und Druckfehler vorbehalten / Errors and Omissions excepted