



PCB terminal block; operating lever; 6 mm²; Pin spacing 7.5 mm; 4-pole; Push-in CAGE CLAMP®

Item No.: 2606-1104/020-000



PCB terminal block; operating lever; 6 mm²; Pin spacing 7.5 mm; 4-pole; Push-in CAGE CLAMP®

Marking

RoHS ✓
Compliant

Business data

Supplier	WAGO
Item no.	2606-1104/020-000
GTIN / EAN	4055143586436
Content	1
Order amount	60
Customer item number	

Notes

Item description: PCB terminal blocks with lever-actuated Push-in CAGE CLAMP® connection Push-in termination of solid and ferruled conductors Intuitive and tool-free operation Several clamping units can be held open simultaneously – convenient for terminating multi-core cables Testing can be performed both parallel and perpendicular to conductor entry

Technical data

Miscellaneous

Available upon request (depending on quantity required):	Other pole numbers
Packaging type	BOX

Technical data	
<i>Ratings per</i>	<i>IEC/EN 60664-1</i>
<i>Rated voltage (III / 3) [V]</i>	<i>800 [V]</i>
<i>Rated impulse voltage (III / 3) [kV]</i>	<i>8 [kV]</i>
<i>Rated voltage (III/2) [V]</i>	<i>1000 [V]</i>
<i>Rated impulse voltage (III / 2) [kV]</i>	<i>8 [kV]</i>
<i>Rated voltage (II / 2) [V]</i>	<i>1000 [V]</i>
<i>Rated impulse voltage (II / 2) [kV]</i>	<i>8 [kV]</i>
<i>Rated current [A]</i>	<i>41 [A]</i>
<i>Legend (ratings)</i>	<i>(III / 2) Overvoltage category III / Pollution degree 2</i>
<i>No. of poles</i>	<i>4</i>
<i>Total number of connection points</i>	<i>4</i>
<i>Total number of potentials</i>	<i>4</i>
<i>Number of connection types</i>	<i>1</i>
<i>Number of levels</i>	<i>1</i>
<i>Connection technology</i>	<i>Push-in CAGE CLAMP®</i>
<i>Actuation type</i>	<i>Operating lever</i>
<i>Solid conductor</i>	<i>0.2 ... 10 mm² / 24 ... 8 AWG</i>
<i>Fine-stranded conductor</i>	<i>0.2 ... 10 mm² / 24 ... 8 AWG</i>
<i>Fine-stranded conductor with ferrule with plastic collar</i>	<i>0.25 ... 6 mm²</i>
<i>Fine-stranded conductor with ferrule without plastic collar</i>	<i>0.25 ... 6 mm² / ...</i>
<i>Strip length</i>	<i>11 ... 13 mm / 0.43 ... 0.51 Inch</i>
<i>Pin spacing</i>	<i>7.5 mm (0.295 in)</i>
<i>Width</i>	<i>32.85 mm / 1.293 Inch</i>
<i>Height</i>	<i>28 mm / 1.102 Inch</i>
<i>Height from the surface</i>	<i>24 mm / 0.945 Inch</i>
<i>Depth</i>	<i>24.3 mm / 0.957 Inch</i>
<i>Solder pin length [mm]</i>	<i>4 [mm]</i>
<i>Solder pin dimensions</i>	<i>1.5 x 1.2 mm</i>
<i>Drilled hole diameter (tolerance) [mm]</i>	<i>2(+ 0.1) [mm]</i>
<i>PCB contact</i>	<i>THT</i>
<i>Solder pin arrangement</i>	<i>over the entire terminal strip, staggered</i>
<i>Number of solder pins per potential</i>	<i>1</i>
<i>Color</i>	<i>gray</i>
<i>Material group</i>	<i>I</i>

Technical data	
<i>Insulating material</i>	<i>Polyamide 66 (PA 66)</i>
<i>Flammability class per UL94</i>	<i>V0</i>
<i>Clamping spring material</i>	<i>Chrome nickel spring steel (CrNi)</i>
<i>Contact material</i>	<i>Electrolytic copper (Ecu)</i>
<i>Contact plating</i>	<i>tin-plated</i>
<i>Fire load [MJ]</i>	<i>0.209 [MJ]</i>
<i>Actuating element color</i>	<i>orange</i>
<i>Weight [g]</i>	<i>15.591 [g]</i>
<i>Limit temperature range</i>	<i>-60 ... 105 °C</i>
<i>Pin spacing from [mm]</i>	<i>7.5 [mm]</i>
<i>Main product function</i>	<i>PCB terminal block</i>
<i>Product type</i>	<i>PCB terminal blocks</i>

Images & drawings

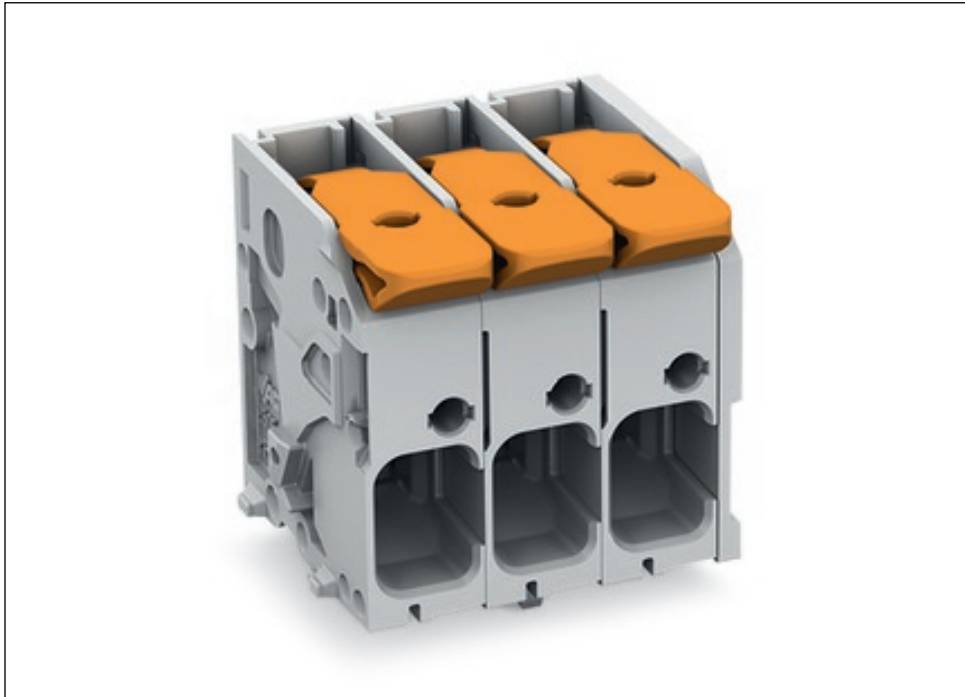



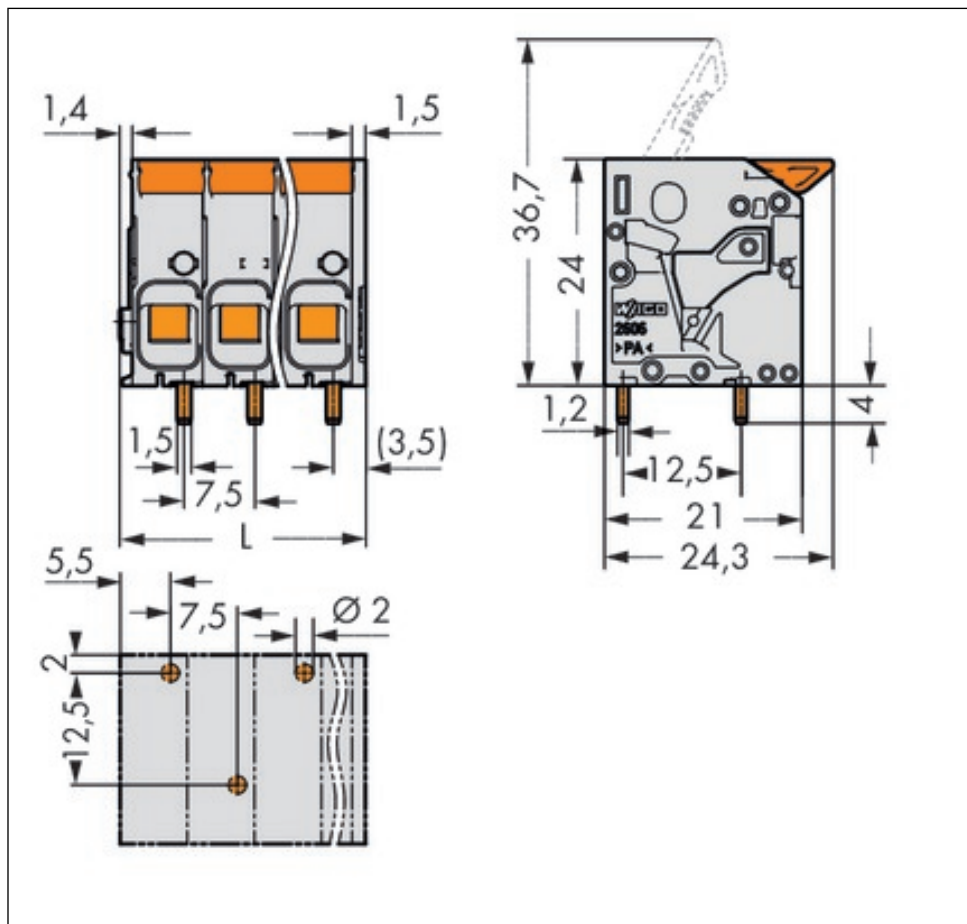

Address

WAGO Kontakttechnik GmbH & Co. KG

Hansastr. 27

32423 Minden

Telefon: 0571/887-0

Fax: 0571/887-169

<http://www.wago.com>

© WAGO Kontakttechnik GmbH & Co. KG

Technische Änderungen und Irrtümer vorbehalten.