



52x52x15 mm

San Ace 52 9GA type Low Power Consumption Fan

General Specifications

- Material Frame: Plastic (Flammability: UL 94V-0), Impeller: Plastic (Flammability: UL 94V-0)
- Expected life See the table below. (L10 life: 90% survival rate for continuous operation in free air at 60°C, rated voltage)
- Motor protection function Locked rotor burnout protection, Reverse polarity protection
For details, please refer to p. 547.
- Dielectric strength 50/60 Hz, 500 VAC, for 1 minute (between lead wire conductors and frame)
- Insulation resistance 10 MΩ or more with a 500 VDC megger (between lead wire conductors and frame)
- Sound pressure level (SPL) At 1 m away from the air inlet
- Storage temperature -30 to +70°C (Non-condensing)
- Lead wire ⊕Red ⊖Black Sensor Yellow Control Brown
- Mass 40 g

Specifications

The models listed below **have ribs and pulse sensors with PWM control function.**

Model no.	Rated voltage [V]	Operating voltage range [V]	PWM duty cycle* [%]	Rated current [A]	Rated input [W]	Rated speed [min ⁻¹]	Max. airflow [m ³ /min] [CFM]	Max. static pressure [Pa] [inchH ₂ O]	SPL [dB (A)]	Operating temperature [°C]	Expected life [h]
9GA0512P7G001	12	10.2 to 13.8	100	0.13	1.56	7800	0.5 17.7	91.5 0.367	38	-20 to +70	40000/60°C
9GA0512P7A001				0.08	0.96	6300	0.4 14.1	59 0.237	32		
9GA0512P7H001				0.05	0.6	4300	0.275 9.7	27.5 0.11	22		
9GA0512P7M001				0.04	0.48	3400	0.215 7.6	17 0.068	16		
9GA0524P7G001	24	20.4 to 27.6	100	0.07	1.68	7800	0.5 17.7	91.5 0.367	38		
9GA0524P7A001				0.05	1.2	6300	0.4 14.1	59.0 0.237	32		
9GA0524P7H001				0.03	0.72	4300	0.275 9.7	27.5 0.11	22		
9GA0524P7M001				0.02	0.48	3400	0.215 7.6	17.0 0.068	16		

* PWM frequency: 25 kHz. Fan does not rotate when PWM duty cycle is 0%.

The following sensor and control options are available for selection.

Available for all models. Without sensor Pulse sensor

Differs according to the model. Refer to the table on p. 570. Lock sensor

Airflow - Static Pressure Characteristics / PWM Duty - Speed Characteristics Example

9GA0512P7G001 With pulse sensor with PWM control function

PWM duty cycle

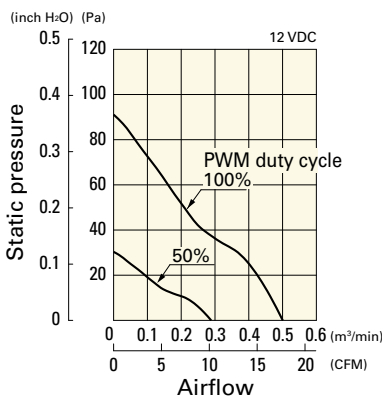

Operating voltage range

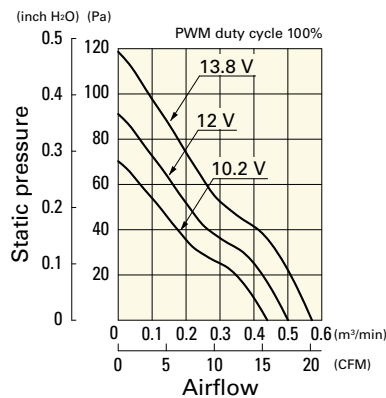

PWM duty - Speed characteristics example

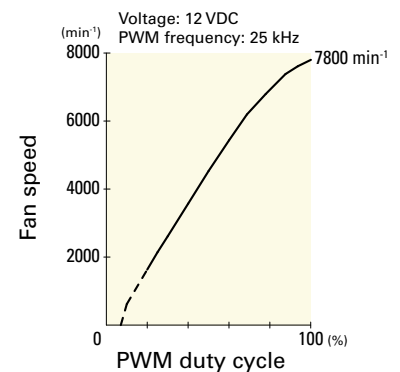

Airflow - Static Pressure Characteristics / PWM Duty - Speed Characteristics Example

DC

DC Fan 52 mm sq.

9GA0512P7A001 With pulse sensor with PWM control function

PWM duty cycle

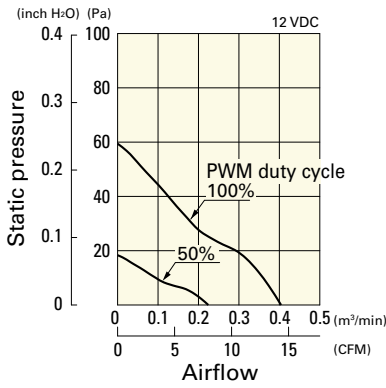

Operating voltage range

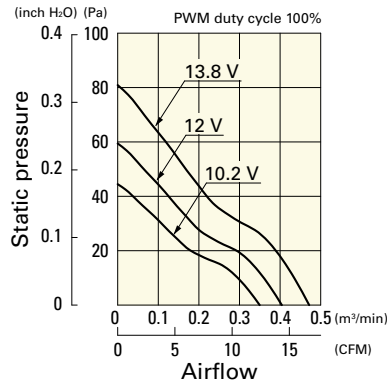

PWM duty - Speed characteristics example

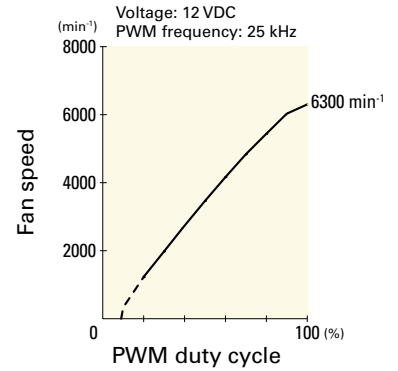

9GA0512P7H001 With pulse sensor with PWM control function

PWM duty cycle

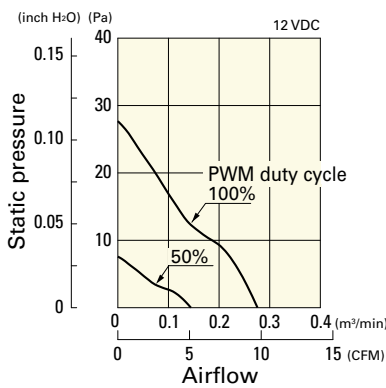

Operating voltage range

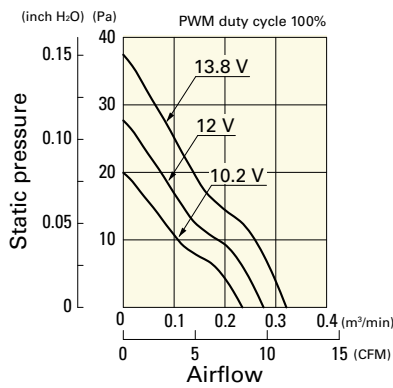

PWM duty - Speed characteristics example

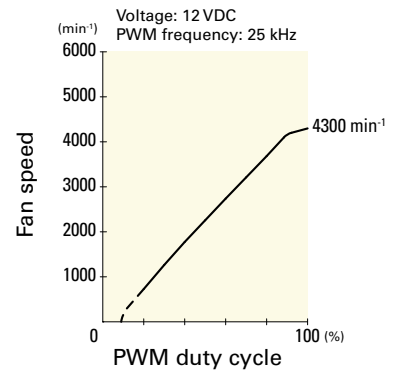

9GA0512P7M001 With pulse sensor with PWM control function

PWM duty cycle

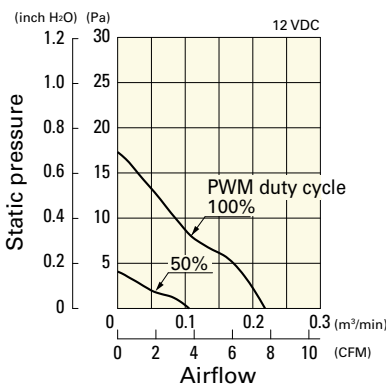

Operating voltage range

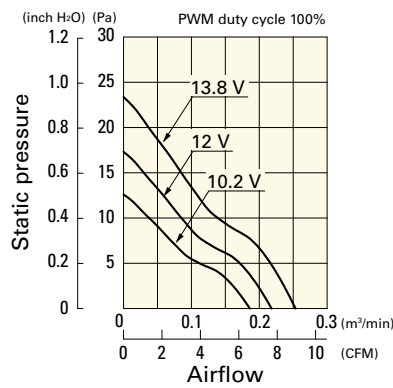

PWM duty - Speed characteristics example

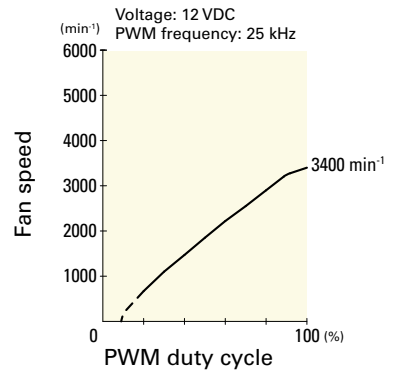

9GA0524P7G001 With pulse sensor with PWM control function

PWM duty cycle

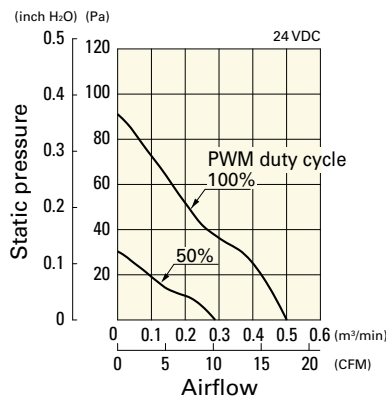

Operating voltage range

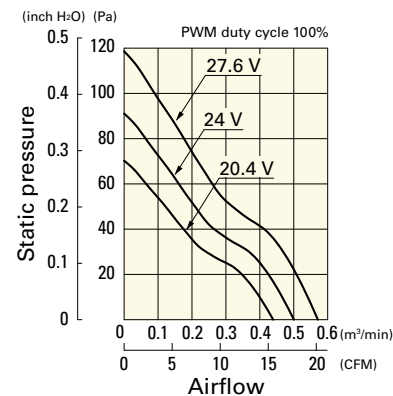

PWM duty - Speed characteristics example

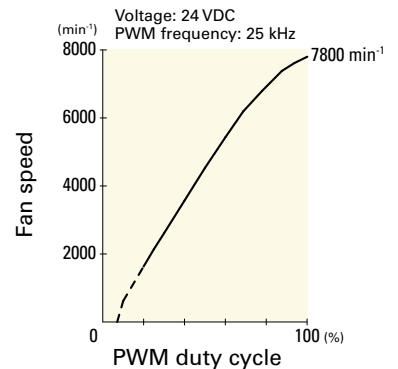

Airflow - Static Pressure Characteristics / PWM Duty - Speed Characteristics Example

9GA0524P7A001 With pulse sensor with PWM control function

PWM duty cycle

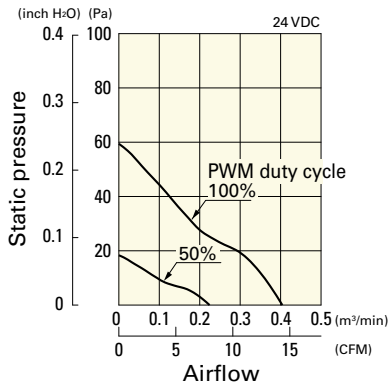

Operating voltage range

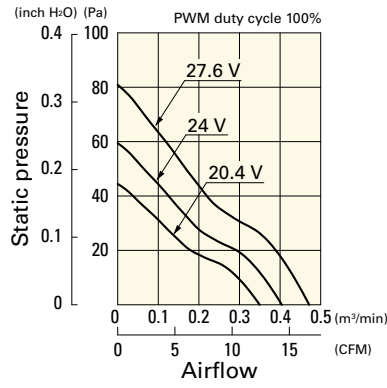

PWM duty - Speed characteristics example

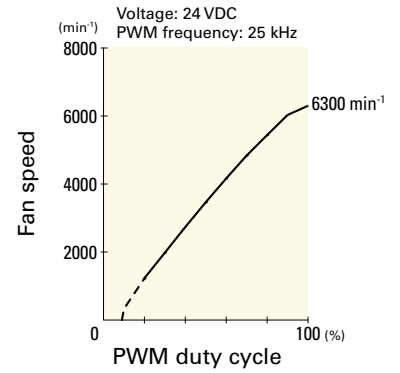

9GA0524P7H001 With pulse sensor with PWM control function

PWM duty cycle

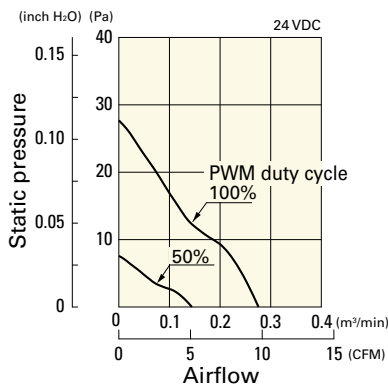

Operating voltage range

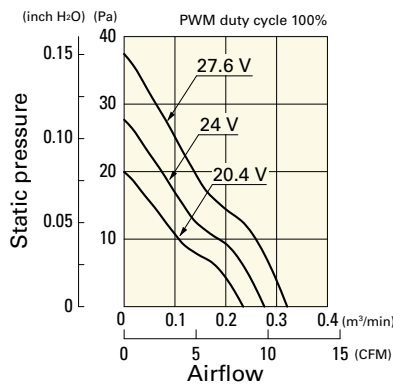

PWM duty - Speed characteristics example

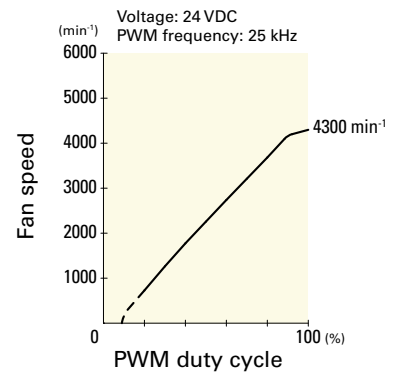

9GA0524P7M001 With pulse sensor with PWM control function

PWM duty cycle

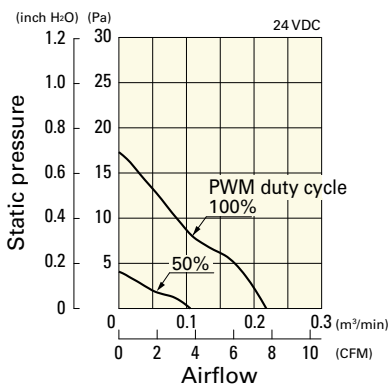

Operating voltage range

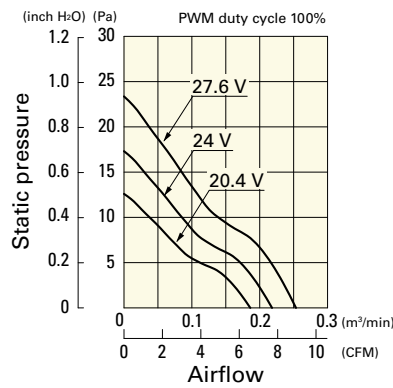

PWM duty - Speed characteristics example

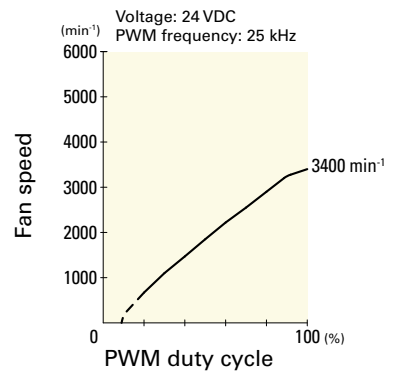

Dimensions (unit: mm)

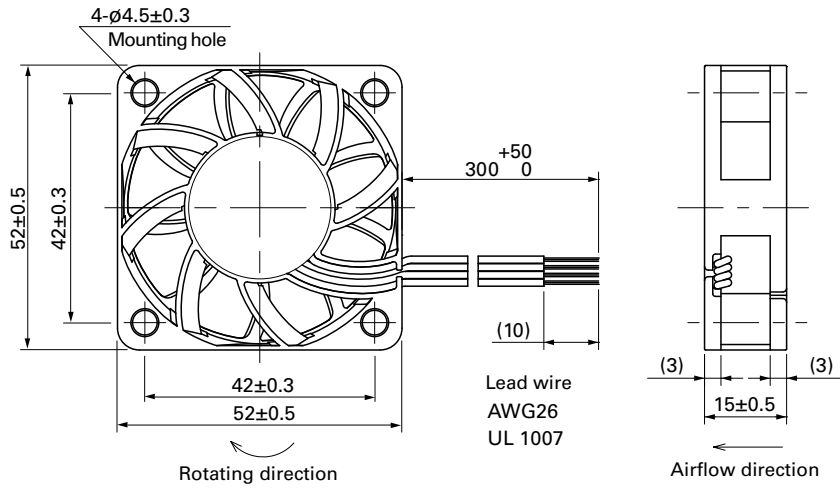

Reference Dimensions of Mounting Holes and Vent Opening (unit: mm)

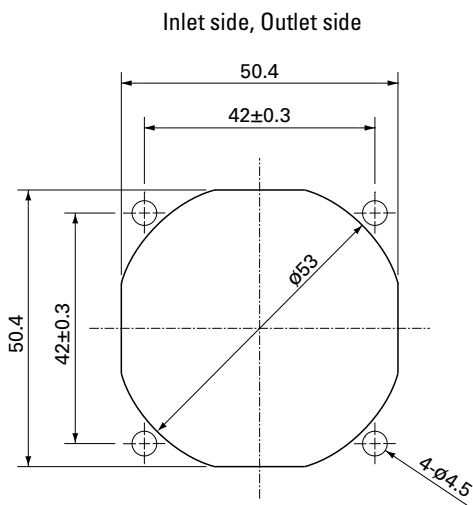

Options

Finger guards

page: p. 532

Model no.: 109-149E, 109-149