

Control & Signalling Devices, Control Stations



Controls & Switchgear Contactors Ltd.

Control & Signalling Units ϕ 22mm (fixing)

Characteristics

General Characteristics	
Products	Push Buttons, Selector Switches, Latching Mushroom Head Push Buttons, Pilot Lights & Illuminated Push Buttons
Reference Standard	IEC 947-5-1, EN 60947-5-1, IEC 337-1, UL 508, CSA C-22-2 n° 14
Approval	
Protection Degree	IP 65 / IP 66 according to IEC 947-1, Nema 4/4X
Pollution Degree	3
Temperature	-40°C ~ + 70°C (Storage) -25°C ~ +70°C (Working)
Vibration Resistance	Mushroom head Push Buttons: 8g, Other Push Buttons & Pilot Lights: 15g (40 to 500 Hz) confirming to IEC 68-2-6
Shock Resistance	Push Buttons : 70g, Mushroom Head Push Buttons: 15g, Selector Switches : 200g conforming to IEC 68-2-27
Working Position	All working positions are allowed
Mechanical Life	Push Buttons & Selector Switches 1 million operations, Emergency Mushroom Push Buttons 300,000 operations

Contact Elements Characteristics	
Rated Thermal Current	I_{th} 10A
Rated Insulation Voltage	U_i 500V conforming to IEC 947-1, UL 508 & CSA 22-2 n° 14
Insulation Category	Group C conforming to NF C 20-040, VDE 0110
Operating Force	Push Buttons - 1 'NO' = 10N, 1 'NC' = 8N Additional contacts - 'NO' = +5N, 'NC' = +3N
Dielectric Strength	2.5KV for 1 minute
Insulation Resistance	2M Ohm min (500 VDC)
Initial Contact Resistance	\leq 25 milli Ohm
Short Circuits Protection	10A 500V, Cartridge Fuse gI or N conforming to IEC 337-1
Terminal Reference	Conforming to CENELEC EN 50013
Connections	On Screw with non loosable plate lamp Sec. 2.5mm ² max. (14 AWG)
Contact Operation	Self Cleaning type, Slow action, Positive Opening
Operation Frequency	3600 Operations per hour
Utilization Category	AC 15 (DC 13)
Rated Power	DC Supply
Conforming to IEC 947-5-1	Power broken in watts
Load factor : 0.5	for 1 million operations
AC Supply (50/60 Hz)	Voltage 24V 48V 120V
	Inductive
	Load 65W 48W 40W

AC Ratings, Inductive - NEMA A600 35% Power Factor

Volts	Make Amperes	VA	Break Amperes	VA	Continuous carrying Amperes	Resistive 75% Power factor Make, Break & continuous Amperes
120	60	7200	6	720	10	10
240	30	7200	3	720	10	10
480	15	7200	1.5	720	10	10
600	12	7200	1.2	720	10	10

DC Ratings, NEMA Type Q600 Inductive and resistive

Volts	Make & Break	Continuous
125	55	2.5
250	0.27	2.5
600	0.10	2.5

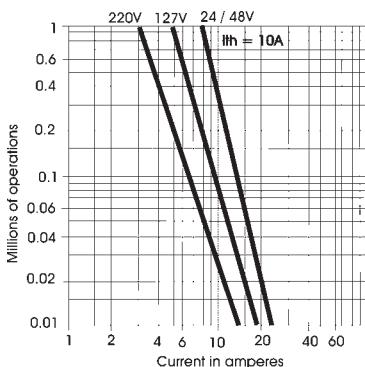

Control & Signalling Units ϕ 22mm (fixing)

Non-Illuminated Push Buttons (Type RB2-B)

(Control Units with chromium plated metal bezel)

Operating Heads for Push Buttons, Spring Return - IP65



RB2-BA4



RB2-BL4



RB2-BP4



RB2-BA48



RB2-BS14



RB2-BT43



RB2-BA3347

Description	Knob Size	Colour	
FLUSH PUSH BUTTON SPRING RETURN		○	RB2-BA1
		●	RB2-BA2
		●	RB2-BA3
		●	RB2-BA4
		●	RB2-BA5
		●	RB2-BA6
		⬆	RB2-BA334
		⬆	RB2-BA335
PROJECTING PUSH BUTTON SPRING RETURN		○	RB2-BL1
		●	RB2-BL2
		●	RB2-BL3
		●	RB2-BL4
		●	RB2-BL5
		●	RB2-BL6
BOOTED PUSH BUTTON SPRING RETURN IP66		○	RB2-BP1
		●	RB2-BP2
		●	RB2-BP3
		●	RB2-BP4
		●	RB2-BP5
		●	RB2-BP6
FLUSH PUSH BUTTON SPRING RETURN WITH TRANSPARENT BOOT IP66		○	RB2-BA18
		●	RB2-BA28
		●	RB2-BA38
		●	RB2-BA48
		●	RB2-BA58
		●	RB2-BA68
MUSHROOM HEAD PUSHBUTTON SPRING RETURN	ϕ 40mm	●	RB2-BC2
		●	RB2-BC3
		●	RB2-BC4
		●	RB2-BC5
		●	RB2-BC6
		MUSHROOM HEAD PUSHBUTTON TURN TO RELEASE	ϕ 30mm
ϕ 40mm	●		RB2-BS54
ϕ 60mm	●		RB2-BS64
MUSHROOM HEAD PUSHBUTTON KEY RELEASE - RAAS KEY NO. 455	ϕ 40mm	●	RB2-BS14
MUSHROOM HEAD PUSHBUTTON PUSH TO STAY AND PULL TO RELEASE	ϕ 40mm	●	RB2-BT4
		● (Pre Marked)	RB2-BT43

Operating Heads with Black metal bezel

TO ORDER ADD SUFFIX '7' TO ABOVE e.g. RB2-BA334 BECOMES RB2-BA3347

- For legend plates refer page 8
- For accessories refer page 7, 8
- For body / contact assemblies refer page 5
- For complete assemblies refer page 9

Control & Signalling Units ϕ 22mm (fixing)

Non-Illuminated Double Headed Push Buttons, Selector Switches & Key Switches (Type RB2-B)

(Control Units with Chromium plated metal bezel)



RB2-BA87

Operating Heads for Double Headed Push buttons, Spring Return w/o Pilot Light- IP40

Description	Marking	Colour	Reference
2 FLUSH PUSH BUTTONS W/O PILOT LIGHT	I O	Green Red	RB2-BA87

Operating Heads for Double Headed Push buttons, With Pilot Light - IP40

1 FLUSH PUSH BUTTON 1 PILOT LIGHT (IN CENTRE) 1 FLUSH PUSH BUTTON	I O	Green Orange Red	RB2BW9
---	--------	------------------------	--------

Available with assembly unit & with following options :

FILAMENT BULB	CLEAR
NEON BULB	●
LED	●



RB2-BW9

Operating Heads for Selector Switches - IP65

Description	Type	Operator	Reference
2 POSITION	STAY PUT	STANDARD HANDLE	RB2-BD2
		LONG HANDLE	RB2-BJ2
	SPRING RETURN TO CENTRE FROM RIGHT & LEFT	STANDARD HANDLE	RB2-BDR2
		LONG HANDLE	RB2-BJR2
3 POSITION	STAY PUT	STANDARD HANDLE	RB2-BD3
		LONG HANDLE	RB2-BJ3
	SPRING RETURN	STANDARD HANDLE	RB2-BDR3
		LONG HANDLE	RB2-BJR3
	1 SPRING RETURN RIGHT TO CENTRE	STANDARD HANDLE	RB2-BD8
		LONG HANDLE	RB2-BJ8
	1 SPRING RETURN LEFT TO CENTRE	STANDARD HANDLE	RB2-BD7
		LONG HANDLE	RB2-BJ7



RB2-BD●

Operating Heads for Key Switches (Raas Key No. 455) - IP65

Description	Type	Key removal	Reference
2 POSITION	STAY PUT	LH POSITION	RB2-BG2
		RH POSITION	RB2-BG02
		ALL POSITIONS	RB2-BG4
	1 SPRING RETURN RIGHT TO LEFT	LH POSITION	RB2-BG6
3 POSITION	STAY PUT	CENTRE POSITION	RB2-BG3
		LH AND RH POSITION	RB2-BG5
		ALL 3 POSITIONS	RB2-BG0
		RH POSITION	RB2-BG09
		LH POSITION	RB2-BG9
	STAY PUT TO LEFT SPRING RETURN FROM RIGHT TO CENTRE	CENTRE POSITION	RB2-BG8
	SPRING RETURN TO CENTRE FROM RIGHT & LEFT	CENTRE POSITION	RB2-BG7



RB2-BJ●



RB2-BG●

Operating Heads with Black metal bezel

TO ORDER ADD SUFFIX '7' TO ABOVE e.g. RB2-BG2 BECOMES RB2-BG27

- For legend plates refer page 8
- For accessories refer page 7, 8
- For contact assemblies refer page 5
- For complete assemblies refer page 9 & 10

Control & Signalling Units ϕ 22mm (fixing)

Illuminated Push Buttons & Selector Switches (Type RB2-B) (Signalling Units with Chromium plated metal bezel)

Operating Heads for Illuminated Push Buttons - IP65



RB2-BW34



RB2-BW14



RB2-BW54

Description	Application	Colour	Reference
FLUSH PUSH BUTTON SPRING RETURN	FOR INCANDESCENT BULBS	○	RB2-BW31
		●	RB2-BW33
		●	RB2-BW34
		●	RB2-BW35
		●	RB2-BW36
		CLEAR	RB2-BW37
PROJECTING PUSH BUTTON SPRING RETURN	FOR INCANDESCENT BULBS	○	RB2-BW11
		●	RB2-BW13
		●	RB2-BW14
		●	RB2-BW15
		●	RB2-BW16
		CLEAR	RB2-BW17
FLUSH PUSH BUTTON SPRING RETURN	FOR LED & NEON BULBS*	●	RB2-BWL33
		●	RB2-BWL34
		●	RB2-BWL35
		●	RB2-BWL36
PROJECTING PUSH BUTTON SPRING RETURN	FOR LED & NEON BULBS*	●	RB2-BWL13
		●	RB2-BWL14
		●	RB2-BWL15
		●	RB2-BWL16
BOOTED TYPE FLUSH PUSH BUTTON ILLUMINATED TYPE	FOR INCANDESCENT BULBS	○	RB2-BW51
		●	RB2-BW53
		●	RB2-BW54
		●	RB2-BW55
		●	RB2-BW56
CLEAR	RB2-BW57		

Operating Heads for Illuminated Selector Switches - IP65



RB2-BK124 /
RB2-BK134

Description	Type	Colour	Reference
2 POSITION	STAY PUT	●	RB2-BK123
		●	RB2-BK124
		●	RB2-BK125
3 POSITION	STAY PUT	●	RB2-BK133
		●	RB2-BK134
		●	RB2-BK135

Operating Heads for Illuminated ϕ 40mm Mushroom Head Operator



RB2-BW4● /
RB2-BW6●

Description	Type	Colour	Reference
2 POSITION MOMENTARY		●	RB2-BW44
		●	RB2-BW43
2 POSITION MAINTAINED		●	RB2-BW64
		●	RB2-BW63

Operating Heads with Black metal bezel

TO ORDER ADD SUFFIX '7' TO ABOVE e.g. RB2-BW31 BECOMES RB2-BW317

- '**' Blue colour is not available in Neon
- For legend plates refer page 8
- For accessories refer page 7, 8
- For contact assemblies refer page 5
- For complete assemblies refer page 10

Control & Signalling Units ϕ 22mm (fixing)

Assemblies for Illuminated, Non-Illuminated type Push Buttons & Selector Switches (Type RB2-B)



RB2-BZ10

Body assemblies with fixing collar & contact blocks (screw clamp terminal connections)

Description	Contact	Type	Reference
FOR PUSHBUTTONS, SELECTOR AND KEY SWITCHES	NO	STANDARD	RB2-BZ101
	NC	STANDARD	RB2-BZ102
	NO+NO	STANDARD	RB2-BZ103
	NC+NC	STANDARD	RB2-BZ104
	NO+NC	STANDARD	RB2-BZ105
	NO	GOLD FLASH	RB2-BZ1016
	NC	GOLD FLASH	RB2-BZ1026
	NO+NO	GOLD FLASH	RB2-BZ1036
	NC+NC	GOLD FLASH	RB2-BZ1046
	NO+NC	GOLD FLASH	RB2-BZ1056



RB2-BE10

Additional / replacement Contact Blocks

Description	Contact	Type	Reference
FOR MAKING UP BODY ASSEMBLIES WITH 3, 4, 5 OR MAXIMUM OF 6 CONTACT BLOCKS OR REPLACING 1 st OR 2 nd CONTACT	NO	STANDARD	RB2-BE101
	NC	STANDARD	RB2-BE102
	NO	GOLD FLASH	RB2-BE1016
	NC	GOLD FLASH	RB2-BE1026

Body assemblies for illuminated Push Buttons & Selectors with or w/o Contacts



RB2-BW06



RB2-BWL7

Description	Supply Voltage	Contact	Colour	Reference
DIRECT BA 9s FILAMENT BULB* SUPPLIED	12V / 24V / 48V / 110V / 130V (AC/DC) \circ	NO + NC		RB2-BW065
		W/O CONTACT BLOCKS		RB2-BW06
THROUGH RESISTOR BA 9s, 130V FILAMENT BULB SUPPLIED	220V (AC/DC)	NO + NC		RB2-BW075
		W/O CONTACT BLOCKS		RB2-BW07
THROUGH RESISTOR & DIODE BA 9s 130V BULB SUPPLIED	240V (AC)	NO + NC		RB2-BWD075
		W/O CONTACT BLOCKS		RB2-BWD07
DIRECT BA 9s NEON BULB SUPPLIED	220V / 380V / 415V (AC/DC) \blacksquare	NO + NC	\bullet	RB2-BWN0635
			\bullet	RB2-BWN0645
			\bullet	RB2-BWN0655
		W/O CONTACT BLOCKS	\bullet	RB2-BWN063
			\bullet	RB2-BWN064
			\bullet	RB2-BWN065
WITH INTEGRAL CIRCUIT & CLUSTER LED	12V, 24V 48V, 110V (AC / DC) 240V (AC) \blacksquare 220V (DC)	NO + NC	\bullet	RB2-BWL735
			\bullet	RB2-BWL745
			\bullet	RB2-BWL755
			\bullet	RB2-BWL765
			\bullet	RB2-BWL76
		W/O CONTACT BLOCKS	\bullet	RB2-BWL73
			\bullet	RB2-BWL74
			\bullet	RB2-BWL75
			\bullet	RB2-BWL76
			\bullet	RB2-BWL76
VIA INTEGRAL TRANSFORMER 1.2 VA BA 9s, 6V FILAMENT BULB SUPPLIED	110V > 6V (AC)	NO + NC		RB2-BW035
		W/O CONTACT		RB2-BW03
FILAMENT BULB SUPPLIED	220V / 240V > 6V (AC)	NO + NC		RB2-BW045
		W/O CONTACT		RB2-BW04

- \circ Body assemblies (suitable for bulb 2.6W max.) upto 230V max. available without bulb
- * Bulb rating 12V to 130V, 2.6W (max.)
- \blacksquare Please mention voltage while ordering
- For accessories refer page 7, 8
- For complete assemblies refer page 9 & 10

Control & Signalling Units ϕ 22mm (fixing)

Pilot Light Heads & Bodies (Type RB2-B)



RB2-BV04



RB2-BV6



RB2-BVN6●



RB2-BVL7●



RCB7-IV-74

Pilot Light Heads

Description	Colour	Reference
FOR INCANDESCENT BULBS	○	RB2-BV01
	●	RB2-BV03
	●	RB2-BV04
	●	RB2-BV05
	●	RB2-BV06
	CLEAR	RB2-BV07
	HIGH CONTRAST, FOR USE WITH NEON BULBS** OR LEDs	●
●		RB2-BVL04
●		RB2-BVL05
●		RB2-BVL06*

Complete Pilot Light Bodies

Supply	Supply voltage	Colour	Reference
DIRECT BA 9s FILAMENT BULB* SUPPLIED	12V / 24V / 48V / 110V / 130V (AC/DC)■○	-	RB2-BV6
THROUGH RESISTOR BA 9s, 130V FILAMENT BULB SUPPLIED	220V (AC / DC)	-	RB2-BV7
THROUGH RESISTOR & DIODE BA 9s, 130V FILAMENT BULB SUPPLIED	240V (AC)	-	RB2-BVD7
VIA INTEGRAL TRANSFORMER 1.2 VA BA 9s, 6V FILAMENT BULB SUPPLIED	110V > 6V (AC)	-	RB2-BV3
	220V / 240V > 6V (AC)	-	RB2-BV4
DIRECT BA 9s, NEON BULB SUPPLIED	220V / 380V / 415V (AC / DC)■	●	RB2-BVN63
		●	RB2-BVN64
		●	RB2-BVN65
INTEGRAL CIRCUIT & CLUSTER LED	12V, 24V, 48V 110V, (AC/DC)■ 220V (DC) 240V (AC)	●	RB2-BVL73
		●	RB2-BVL74
		●	RB2-BVL75
		●	RB2-BVL76

Integrated LED Pilot Lamps❖

Supply	Supply voltage	Colour	Reference
INTEGRATED LED PILOT LAMPS AT 240V AC & 220V DC AT 110V, 48V, 24V, & 12V AC/DC , CIRCUITS	12V, 24V, 48V 110V, (AC/DC) 220V (DC) 240V (AC)	○	RCB7-IV-71
		●	RCB7-IV-73
		●	RCB7-IV-74
		●	RCB7-IV-75
		●	RCB7-IV-76
		CLEAR	RCB7-IV-77
		●	RCB7-IV-78

- ○ Body assemblies (suitable for bulb 2.6W max.) upto 230V max. available without bulb
- * Bulb rating 12V to 130V, 2.6W (max.)
- ** not available in Neon Bulbs
- ■ Please mention voltage while ordering
- For accessories refer page 7, 8
- For legend plates refer page 8
- For complete assemblies refer page 10
- ❖ under UL approval

Control & Signalling Units ϕ 22mm (fixing)

Accessories



RL1-CF■



RL1-CN●■



RB2-BV004



RB2-BP004



RC-S

Bulbs			
Description	Voltage	Colour	Reference
INCANDESCENT FILAMENT LAMP (Different wattage for various voltages)	6V, 12V, 24V, 48V, 130V	CLEAR	RL1-CF■
NEON BA 9s	220V, 380V, 415V	●	RL1-CN3■
		●	RL1-CN4■
		●	RL1-CN5■
Lenses			
Description		Colour	Reference
SET OF LENSES (ONE INNER DIFFUSER & ONE OUTER LENS) FOR PILOT LAMP HEAD		○	RB2-BV001
		●	RB2-BV003
		●	RB2-BV004
		●	RB2-BV005
		●	RB2-BV006
		CLEAR	RB2-BV007
	SET OF LENS FOR (ONE INNER DIFFUSER & ONE OUTER LENS) FOR ILLUMINATING ACTUATOR		○
		●	RB2-BW003
		●	RB2-BW004
		●	RB2-BW005
		●	RB2-BW006
		CLEAR	RB2-BW007
LENSES FOR ILLUMINATING LED & NEON* ACTUATOR (WITHOUT INNER DIFFUSER)			●
		●	RB2-BWL004
		●	RB2-BWL005
		●	RB2-BWL006
Boots			
Description		Colour	Reference
SILICON RUBBER (FOR RB2-BP) BOOTS (SUITABLE FOR OIL & HUMID CONDITION)		○	RB2-BP001
		●	RB2-BP002
		●	RB2-BP003
		●	RB2-BP004
		●	RB2-BP005
		●	RB2-BP006
BOOTS SUITABLE FOR NON-ILLUMINATING FLUSH PUSHBUTTONS (RB2-BA)		CLEAR	RC-S
BOOTS SUITABLE FOR ILLUMINATED FLUSH PUSHBUTTONS (RB2-BW)		CLEAR	RC-L

- '■' Replace with voltage
- '*' Blue lense for neon type lamp not available

Control & Signalling Units ϕ 22mm (fixing)

Accessories & Legend Plates



RB2-B



RB2-RPX



RB2-QC12



RB2 - K455

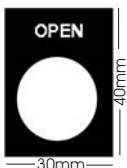

RB2-BY



RB2-PY9330

Other Accessories & Tools

Description	Reference
FIXING COLLAR	RB2-B
RESET PLUNGER	RB2-RPX
BULB EXTRACTOR FOR BA 9s BULBS	RBF-X13
QUICK CONNECTOR FOR NO / NC CONTACT	RB2-QC12
SPARE / REPLACEMENT KEYS FOR KEY OPERATING UNITS (RAAS KEY NO. 455)	RB2-K455
PADLOCKING ATTACHMENT (MAKES FLUSH OPERATOR INACCESSIBLE)	RB2-BZ6
PANEL ADPATOR CONVERTS 30mm HOLE TO 22mm HOLE	RB2-BZ41

Legend Plates *

Standard Text	Reference
■	RB2-BY2301
START	RB2-BY2303
FORWARD	RB2-BY2305
UP	RB2-BY2307
ON	RB2-BY2311
OPEN	RB2-BY2313
AUTO	RB2-BY2315
RESET	RB2-BY2323
SLOW	RB2-BY2327
AUTO-HAND	RB2-BY2364
STOP	RB2-BY2304
REVERSE	RB2-BY2306
DOWN	RB2-BY2308
OFF	RB2-BY2312
CLOSE	RB2-BY2314
HAND	RB2-BY2316
INCH	RB2-BY2321
FAST	RB2-BY2328
AUTO-O-HAND	RB2-BY2385
HAND OFF AUTO	RB2-BY2387
EMERGENCY STOP	RB2-BY2330
LOW	RB2-BY2333
HIGH	RB2-BY2334
HIGH LOW	RB2-BY2335
OFF ON	RB2-BY2336
STOP START	RB2-BY2337
UP DOWN	RB2-BY2328
EMERGENCY STOP PLASTIC ϕ 60mm	RB2-PY9330
EMERGENCY STOP PLASTIC ϕ 90mm	RB2-PY8330
EMERGENCY STOP ALUMINIUM ϕ 60mm	RB2-AY9330
EMERGENCY STOP ALUMINIUM ϕ 90mm	RB2-AY8330

- ■ without any text
- * Available in Plastic also. Replace 'BY' with 'PY'

Dimensions / Complete Units' Reference

Control Units ϕ 22mm fixing

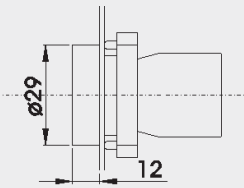
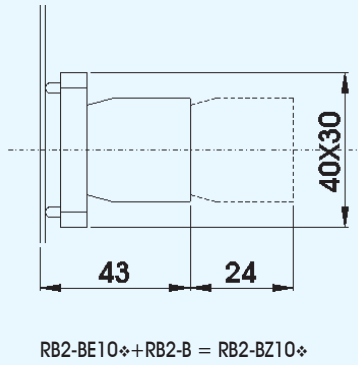
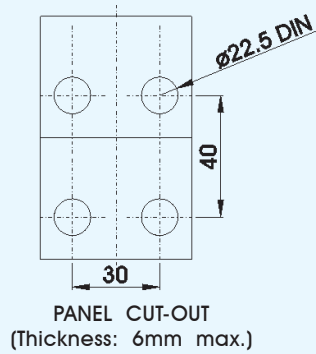

RB2-BA \bullet +RB2-BZ10 \diamond =RCB2-BA \bullet \diamond
RB2-BA334+RB2-BZ10 \diamond =RB2-BA334 \diamond

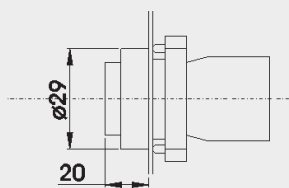

RB2-BL \bullet +RB2-BZ10 \diamond =RCB2-BL \bullet \diamond

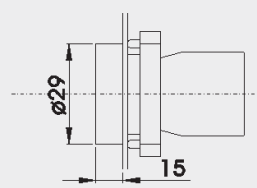

RB2-BP \bullet +RB2-BZ10 \diamond =RCB2-BP \bullet \diamond
RB2-BA \bullet 8+RB2-BZ10 \diamond =RCB2-BA \bullet 8 \diamond

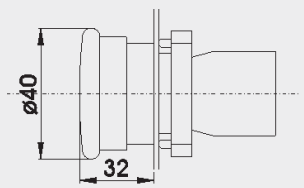

RB2-BC \bullet +RB2-BZ10 \diamond =RCB2-BC \bullet \diamond
RB2-BS54+RB2-BZ10 \diamond =RCB2-BS54 \diamond
RB2-BT4+RB2-BZ10 \diamond =RCB2-BT4 \diamond

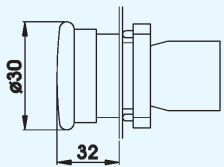

RB2-BS44+RB2-BZ10 \diamond =RCB2-BS44 \diamond

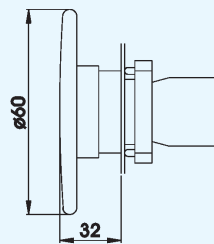

RB2-BS64+RB2-BZ10 \diamond =RCB2-BS64 \diamond

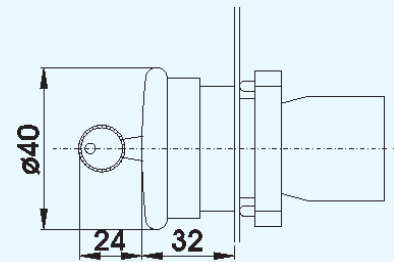

RB2-BS14+RB2-BZ10 \diamond =RCB2-BS14 \diamond

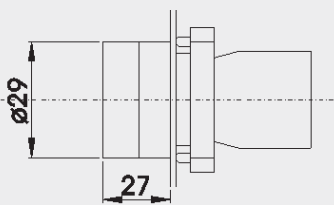

RB2-BD2+RB2-BZ10 \diamond =RCB2-BD2 \diamond
RB2-BD3+RB2-BZ10 \diamond =RCB2-BD3 \diamond

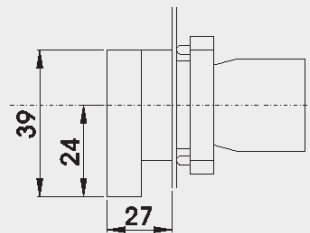

RB2-BJ2+RB2-BZ10 \diamond =RCB2-BJ2 \diamond
RB2-BJ3+RB2-BZ10 \diamond =RCB2-BJ3 \diamond

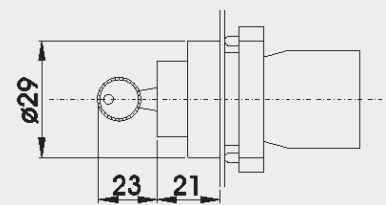

RB2-BG \blacklozenge +RB2-BZ10 \diamond =RCB2-BG \blacklozenge \diamond
Replace \blacklozenge with code for position of Key removal & operation pattern

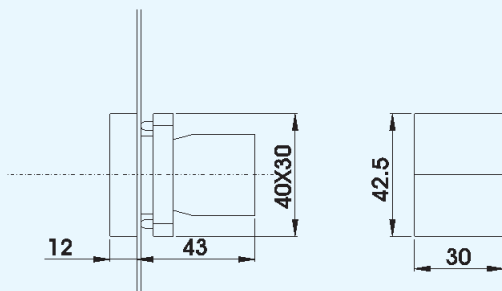

RB2-BA87+RB2-BZ10 \diamond =RCB2-BA87 \diamond

- Replace \diamond with codes for type of contacts (See page 5) & \bullet with colour codes (see page 2 & 3)
- For non-illuminated push button heads, selector switches & key switches refer page 2 & 3

Dimensions / Complete Units' Reference

Signalling Unit ϕ 22mm fixing

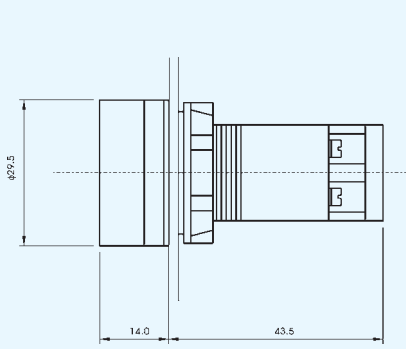

RCB7-IV-7●

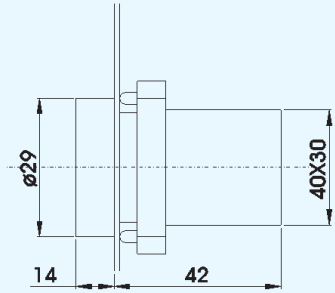

RB2-BV0●+RB2-BV6 = RCB2-BV6●
 RB2-BV0●+RB2-BVN6 = RCB2-BVN6●
 RB2-BV0●+RB2-BV7 = RCB2-BV7●
 RB2-BV0●+RB2-BVD7 = RCB2-BVD7●
 RB2-BVL0●+RB2-BVL7● = RCB2-BVL7●

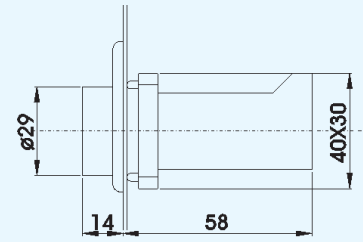

RB2-BV0●+RB2-BV3 = RCB2-BV3●
 RB2-BV0●+RB2-BV4 = RCB2-BV4●

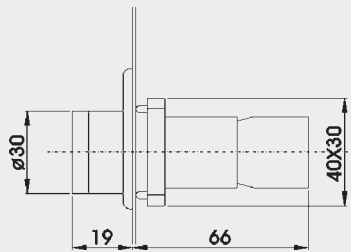

RB2-BW5●+RB2-BW06+RB2-BE10✧ = RCB2-BW5●6✧
 RB2-BW5●+RB2-BW07+RB2-BE10✧ = RCB2-BW5●7✧
 RB2-BW5●+RB2-BWD07+RB2-BE10✧ = RCB2-BWD5●7✧
 RB2-BW5●+RB2-BW06+RB2-BE10✧ = RCB2-BW5●6✧

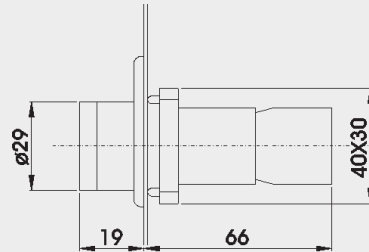

RB2-BW3●+RB2-BW06+RB2-BE10✧ = RCB2-BW3●6✧
 RB2-BW3●+RB2-BW07+RB2-BE10✧ = RCB2-BW3●7✧
 RB2-BW3●+RB2-BWD07+RB2-BE10✧ = RCB2-BWD3●7✧
 RB2-BWL3●+RB2-BWN06●+RB2-BE10✧ = RCB2-BWN3●6✧
 RB2-BWL3●+RB2-BWL7●+RB2-BE10✧ = RCB2-BWL3●7✧

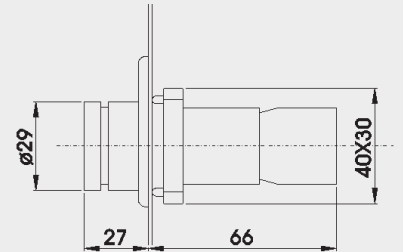

RB2-BK12●+RB2-BW06 = RCB2-BK12●6✧
 RB2-BK12●+RB2-BW07 = RCB2-BK12●7✧
 RB2-BK12●+RB2-BWD07 = RCB2-BKD12●7✧
 RB2-BK13●+RB2-BW06 = RCB2-BK13●6✧
 RB2-BK13●+RB2-BW07 = RCB2-BK13●7✧
 RB2-BK13●+RB2-BWD07 = RCB2-BKD13●7✧

RB2-BW1●+RB2-BW06+RB2-BE10✧ = RCB2-BW1●6✧
 RB2-BW1●+RB2-BW07+RB2-BE10✧ = RCB2-BW1●7✧
 RB2-BW1●+RB2-BWD07+RB2-BE10✧ = RCB2-BWD1●7✧
 RB2-BWL1●+RB2-BWN06●+RB2-BE10✧ = RCB2-BWN3●6✧
 RB2-BWL1●+RB2-BWL7●+RB2-BE10✧ = RCB2-BWL3●7✧

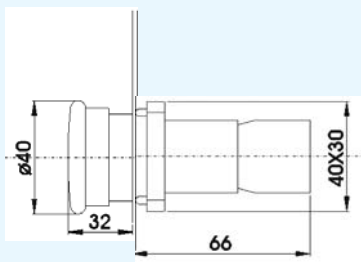

RB2-BW4●+RB2-BW06+RB2-BE10✧ = RCB2-BW4●6✧
 RB2-BW4●+RB2-BW07+RB2-BE10✧ = RCB2-BW4●7✧
 RB2-BW4●+RB2-BWD07+RB2-BE10✧ = RCB2-BWD4●7✧
 RB2-BW4●+RB2-BWN06●+RB2-BE10✧ = RCB2-BWN4●6✧
 RB2-BW4●+RB2-BWL7●+RB2-BE10✧ = RCB2-BWL4●7✧
 RB2-BW6●+RB2-BW06+RB2-BE10✧ = RCB2-BW6●6✧
 RB2-BW6●+RB2-BW07+RB2-BE10✧ = RCB2-BW6●7✧
 RB2-BW6●+RB2-BWD07+RB2-BE10✧ = RCB2-BWD6●7✧
 RB2-BW6●+RB2-BWN06●+RB2-BE10✧ = RCB2-BWN6●6✧
 RB2-BW6●+RB2-BWL7●+RB2-BE10✧ = RCB2-BWL6●7✧

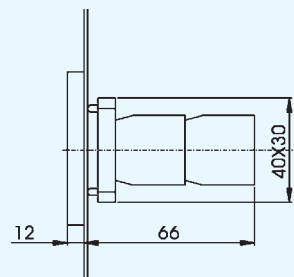

RB2-BW9+RB2-BW06+RB2-BE10✧ = RCB2-BW96✧
 RB2-BW9+RB2-BW07+RB2-BE10✧ = RCB2-BW97✧
 RB2-BW9+RB2-BWD07+RB2-BE10✧ = RCB2-BWD97✧
 RB2-BW9+RB2-BWN065+RB2-BE10✧ = RCB2-BWN965✧
 RB2-BW9+RB2-BWL75+RB2-BE10✧ = RCB2-BWL975✧

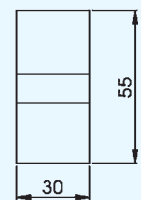

- Replace '✧' with codes for type of contacts (See page 5) & '●' with colour codes (see page 4 & 5)
- For illuminated push button heads, illuminated selector switches please refer page 4
- For pilot lamp head please refer page 6 & for double headed push button with pilot lamp please refer page 3

Control Stations



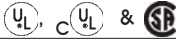















Characteristics

General Characteristics	
Products	Control Stations
Reference Standard	IEC 947-5-1, EN 60947-5-1, IEC 337-1, UL 508, CSA C-22-2 n° 14
Approval	
Protection Degree	IP 65 / IP 66 (as per IEC), NEMA 4 / 4X (special version)
Ambient Temperature	-40°C ~ + 70°C (Storage) -25°C ~ +70°C (Operation)
Vibration Resistance	15g (40 To 500 Hz) conforming to IEC 68-2-6
Shock Resistance	Push Buttons : 70g, Mushroom Head Push Buttons : 15g, Selector Switches : 200g conforming to IEC 68-2-27
Material and Colour	Thermoplastic - grey lid and black base for 1,2,3,4 way, yellow lid & black base for one way Aluminium Die Cast - grey lid and dark grey base
Cable Entry	Knock-outs provided



Stations for customer assembly

Empty Control Station Enclosures for customer assembly in plastic & metal

Description	No. of Holes	Colour	Reference
CONTROL STATION PLASTIC ENCLOSURE	1	LID  BASE 	RC-1P
	2	LID  BASE 	RC-2P
	3	LID  BASE 	RC-3P
	4	LID  BASE 	RC-4P
	1	LID  BASE 	RC-1PY
CONTROL STATION METAL ENCLOSURE	1	LID  BASE 	RC-1M
	2	LID  BASE 	RC-2M
	3	LID  BASE 	RC-3M
	4	LID  BASE 	RC-4M

Control Stations

Stations for customer assembly

Plastic Operating Heads for use with RC•P & RC•M enclosures - IP65



RP2-BA334

Description	Knob Size	Colour	Reference
FLUSH PUSH BUTTON SPRING RETURN		○	RP2-BA1
		●	RP2-BA2
		●	RP2-BA3
		●	RP2-BA4
		●	RP2-BA5
		●	RP2-BA6
		↑	RP2-BA334
		ⓘ	RP2-BA335
PROJECTING PUSH BUTTON SPRING RETURN		○	RP2-BL1
		●	RP2-BL2
		●	RP2-BL3
		●	RP2-BL4
		●	RP2-BL5
		●	RP2-BL6
MUSHROOM HEAD PUSH BUTTON SPRING RETURN		●	RP2-BC2
		●	RP2-BC3
	φ40mm	●	RP2-BC4
		●	RP2-BC5
MUSHROOM HEAD PUSH BUTTON TURN TO RELEASE	φ30mm	●	RP2-BS44
	φ40mm	●	RP2-BS54
	φ60mm	●	RP2-BS64
MUSHROOM HEAD PUSHBUTTON	φ40mm	●	RP2-BS14



RP2-BL4

Plastic Selector Heads for use with RC•P & RC•M enclosures - IP65



RP2-BD•

Description	Type	Operator	Reference
2 POSITION	STAY PUT	STANDARD HANDLE	RP2-BD2
		LONG HANDLE	RP2-BJ2
3 POSITION	STAY PUT	STANDARD HANDLE	RP2-BD3
		LONG HANDLE	RP2-BJ3
	SPRING RETURN	STANDARD HANDLE	RP2-BDR3
		LONG HANDLE	RP2-BJR3
3 POSITION	1 SPRING RETURN RIGHT TO CENTRE	STANDARD HANDLE	RP2-BD8
		LONG HANDLE	RP2-BJ8
	1 SPRING RETURN LEFT TO CENTRE	STANDARD HANDLE	RP2-BD7
		LONG HANDLE	RP2-BJ7

Plastic Key Selector Heads for use with RC•P & RC•M enclosures - IP65



RP2-BG•

Description	Type	Key Removal	Reference
2 POSITION KEY SWITCH (RAAS KEY NO. 455)	STAY PUT	LH POSITION	RP2-BG2
		RH POSITION	RP2-BG02
		ALL POSITIONS	RP2-BG4
3 POSITION	STAY PUT	CENTRE POSITION	RP2-BG3
		LH AND RH POSITION	RP2-BG5
		ALL 3 POSITIONS	RP2-BG0
		RH POSITION	RP2-BG09
	LH POSITION	RP2-BG9	
	BOTH SIDE SPRING RETURN TO CENTRE	CENTRE POSITION	RP2-BG7
		STAY PUT TO LEFT SPRING RETURN FROM RIGHT TO CENTRE	CENTRE POSITION

Control Stations

Stations for customer assembly



RB2-BE•BP



RM2-BA4



RM2-BA335



RM2-BL4



RM2-BP4



RM2-BS54



RM2-BS14

Contact Blocks with RC•P enclosures - IP65

Description	Contact	Type	Reference
FOR MAKING UP BODY ASSEMBLIES WITH 3, 4, 5 OR MAXIMUM OF 6 CONTACT BLOCKS OR REPLACING 1 st OR 2 nd CONTACT	NO	STANDARD	RB2-BE101-BP
	NC	STANDARD	RB2-BE102-BP
	NO	GOLD FLASH	RB2-BE1016-BP
	NC	GOLD FLASH	RB2-BE1026-BP

Metal Operating Heads for use with RC•P & RC•M enclosures - IP65

Description	Knob Size	Colour	Reference
FLUSH PUSH BUTTON SPRING RETURN		○	RM2-BA1
		●	RM2-BA2
		●	RM2-BA3
		●	RM2-BA4
		●	RM2-BA5
		●	RM2-BA6
		ⓘ	RM2-BA334
		ⓘ	RM2-BA335
PROJECTING PUSH BUTTON SPRING RETURN		○	RM2-BL1
		●	RM2-BL2
		●	RM2-BL3
		●	RM2-BL4
		●	RM2-BL5
		●	RM2-BL6
		○	RM2-BP1
		●	RM2-BP2
BOOTED PUSH BUTTON SPRING RETURN IP66		●	RM2-BP3
		●	RM2-BP4
		●	RM2-BP5
		●	RM2-BP6
		○	RM2-BA18
		●	RM2-BA28
		●	RM2-BA38
		●	RM2-BA48
FLUSH PUSH BUTTON SPRING RETURN WITH TRANSPARENT BOOT IP66		●	RM2-BA58
		●	RM2-BA68
		●	RM2-BC2
		●	RM2-BC3
		●	RM2-BC4
		●	RM2-BC5
		●	RM2-BC6
		MUSHROOM HEAD PUSHBUTTON SPRING RETURN	φ40mm
●	RM2-BS54		
●	RM2-BS64		
●	RM2-BS14		
MUSHROOM HEAD PUSH BUTTON TURN TO RELEASE	φ30mm	●	RM2-BS44
	φ40mm	●	RM2-BS54
	φ60mm	●	RM2-BS64
MUSHROOM HEAD PUSHBUTTON KEY RELEASE - RAAS KEY NO. 455	φ40mm	●	RM2-BS14
MUSHROOM HEAD PUSHBUTTON PUSH TO STAY - PULL TO RELEASE	φ40mm	●	RM2-BT4
		● (Pre-marked)	RM2-BT43

Operating Heads with Black metal bezel

TO ORDER ADD SUFFIX '7' TO ABOVE e.g. RM2-BA1 BECOMES RM2-BA17

Control Stations

Stations for customer assembly



RM2-BD●



RB2-BJ●



RB2-BG●



RB2-BE10● -BM

Metal Selector Heads for use with RC●P & RC●M enclosures - IP65

Description	Type	Operator	Reference	
2 POSITION	STAY PUT	STANDARD HANDLE	RM2-BD2	
		LONG HANDLE	RM2-BJ2	
	SPRING RETURN	STANDARD HANDLE	RM2-BDR2	
		LONG HANDLE	RM2-BJR2	
3 POSITION	STAY PUT	STANDARD HANDLE	RM2-BD3	
		LONG HANDLE	RM2-BJ3	
	SPRING RETURN	STANDARD HANDLE	RM2-BDR3	
		LONG HANDLE	RM2-BJR3	
	3 POSITION	1 SPRING RETURN	STANDARD HANDLE	RM2-BD8
		RIGHT TO CENTRE	LONG HANDLE	RM2-BJ8
1 SPRING RETURN		STANDARD HANDLE	RM2-BD7	
LEFT TO CENTRE		LONG HANDLE	RM2-BJ7	

Metal Key Selector Heads for use with RC●P & RC●M enclosures - IP65

Description	Key Removal	Key Removal	Reference		
2 POSITION KEY SWITCH (RAAS KEY NO. 455)	STAY PUT	LH POSITION	RM2-BG2		
		RH POSITION	RM2-BG02		
		ALL POSITIONS	RM2-BG4		
	1 SPRING RETURN RIGHT TO LEFT	LH POSITION	RM2-BG6		
		3 POSITION	STAY PUT	CENTRE POSITION	RM2-BG3
			LH AND RH POSITION	RM2-BG5	
ALL 3 POSITIONS	RM2-BG0				
RH POSITION	RM2-BG09				
BOTH SIDE SPRING RETURN TO CENTRE	LH POSITION	RM2-BG9			
	CENTRE POSITION	RM2-BG7			
	STAY PUT TO LEFT SPRING RETURN FROM RIGHT TO CENTRE	CENTRE POSITION	RM2-BG8		

Contact Blocks Base Mounted for use with RC●M enclosures - IP65

Description	Contact	Type	Reference
Contact Blocks	NO	STANDARD	RB2-BE101-BM
	NC	STANDARD	RB2-BE102-BM
	NO	GOLD FLASH	RB2-BE1016-BM
	NC	GOLD FLASH	RB2-BE1026-BM

Dimensions

	Plastic				Metal			
	1 Hole (inch/mm)	2 Hole (inch/mm)	3 Hole (inch/mm)	4 Hole (inch/mm)	1 Hole (inch/mm)	2 Hole (inch/mm)	3 Hole (inch/mm)	4 Hole (inch/mm)
H	2.1" / 51	2.1" / 51	2.1" / 51	2.1" / 51	2.1" / 51	2.1" / 51	2.1" / 51	2.1" / 51
W	2.68" / 68	2.68" / 68	2.68" / 68	2.68" / 68	2.68" / 68	2.68" / 68	2.68" / 68	2.68" / 68
L	2.91" / 74	4.09" / 104	5.28" / 134	6.46" / 164	2.91" / 74	4.13" / 105	5.28" / 134	6.46" / 164
WI	2.13" / 54	2.13" / 54	2.13" / 54	2.13" / 54	2.13" / 54	2.13" / 54	2.13" / 54	2.13" / 54
LI	1.5" / 38	2.68" / 68	2.68" / 68	5.04" / 128	1.31" / 46	3.07" / 78	4.25" / 108	5.43" / 138

