

W 100 S - 8 Ohm

Art. No. 9021



10 cm (4") HiFi-Tiefmitteltöner mit beschichteter Papiermembran, elastischer Gummisicke und temperaturstabiler 20-mm-Schwingspule. Einsetzbar als Tieftöner in Miniboxen und durch sehr ausgeglichenen Frequenzgang besonders als Tiefmitteltöner in 3-Wege-Boxen und Satellitensystemen für Subwoofer-Anlagen geeignet.

10 cm (4") HiFi low-midrange driver with coated paper cone, elastic rubbersurround and 20 mm voice-coil. Suitable as woofer in mini-speaker systems and due to the very balanced frequency response especially suitable as low-midrange driver in 3-way speakers and in subwoofer /satellite systems.

Gehäuseempfehlungen / Recommended cabinets

Volumen/Prinzip	BR-Rohr	f_b	f_c/Q_{TC}
4 l/geschlossen	-	-	96 Hz/0,82
5 l/Bassreflex	BR 6.8 (6 cm lang)	70 Hz	-
10 l/Bassreflex	BR 6.8 (5 cm lang)	56 Hz	-

Volume/Principle	BR-Channel	f_b	f_c/Q_{TC}
4 l/closed	-	-	96 Hz/0,82
5 l/bass reflex	BR 6.8 (length 6 cm)	70 Hz	-
10 l/bass reflex	BR 6.8 (length 5 cm)	56 Hz	-

01.10.2015

W 100 S - 8 Ohm

Art. No. 9021

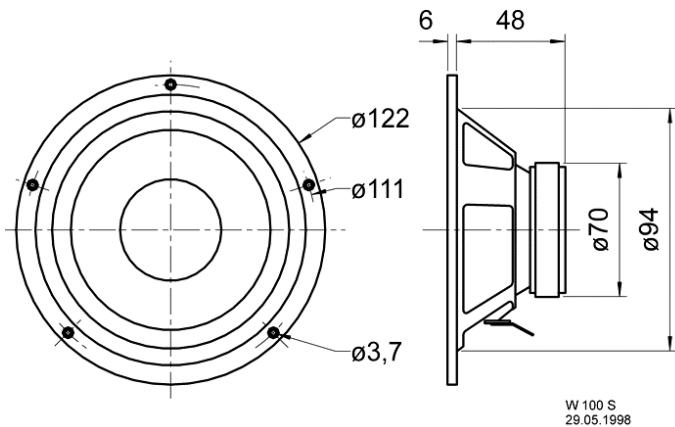
W 100 S
29.05.1998

Technische Daten / Technical data

Nennbelastbarkeit Rated power	30 W
Musikbelastbarkeit Maximum power	50 W
Nennimpedanz Z Nominal impedance Z	8 Ohm
Übertragungsbereich Frequency response	fu-15000 Hz
(fu: untere Grenzfrequenz abhängig vom Gehäuse) (fu: Lower cut-off frequency depending on cabinet)	.
Mittlerer Schalldruckpegel Mean sound pressure level	86 dB (1 W/1 m)
Abstrahlwinkel (-6 dB) Opening angle (-6 dB)	86°/4000 Hz
Grenzauslenkung Excursion limit	+/-4 mm
Resonanzfrequenz fs Resonance frequency fs	63 Hz
Magnetische Induktion Magnetic induction	1 T
Magnetischer Fluss Magnetic flux	250 μ Wb
Obere Polplattenhöhe Height of front pole-plate	4 mm
Schwingspulendurchmesser Voice coil diameter	20 mm
Wickelhöhe Height of winding	8 mm
Schallwandöffnung Cutout diameter	94 mm
Gewicht netto Net weight	0,49 kg
Gleichstromwiderstand Rdc D.C. resistance Rdc	6,7 Ohm
Mechanischer Q-Faktor Qms Mechanical Q factor Qms	2,74
Elektrischer Q-Faktor Qes Electrical Q factor Qes	0,67
Gesamt-Q-Faktor Qts Total Q factor Qts	0,54

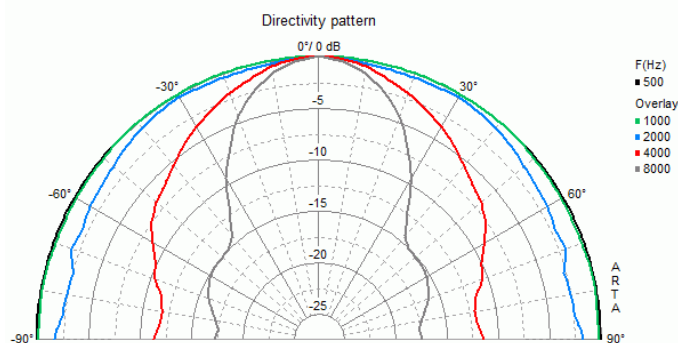
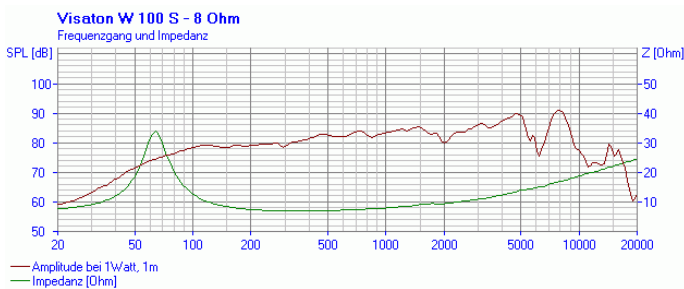

01.10.2015

Äquivalentes Luftnachgiebigkeitsvolumen Vas Equivalent volume Vas	5,41 l
Effektive Membranfläche Sd Effective piston area Sd	53 cm ²
Dynamische bewegte Masse Mms Dynamically moved mass Mms	4,7 g
Antriebsfaktor Bxl Force factor Bxl	4,29 Tm
Schwingspuleninduktivität L Inductance of the voice coil L	0,9 mH