

## Spoked Handwheels • light metal

24610.0115

### Product Description

For all handwheels, the hub is machined, rim is turned and mirror-finished on all sides. The unmachined raw surfaces have been blasted clean. Together with their mirror-polished rim, these handwheels therefore present a finish which generally does not require additional lacquering.



#### Material

##### Axle part

- Steel, zinc-plated by galvanization

##### Handwheel

- Aluminium permanent-mould casting

#### Assembly

Shaft-end washers EH 22270. for axial fastening.

#### More information

#### Further products

- Shaft-End Washers
- Cylindrical Handles, rotating

### Drawing

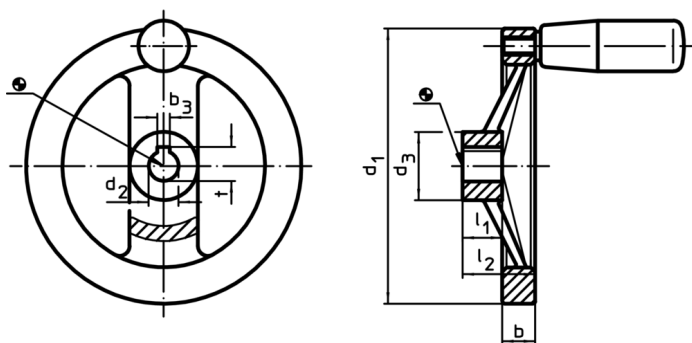

The orientation of the hub keyway may be different than shown in the drawing.

### Order information

d <sub>1</sub>	d <sub>2</sub> H7	Dimensions				l <sub>1</sub>	l <sub>2</sub> ~	Hub keyway, DIN 6885 sheet 1		[g]	Art. No.
		d <sub>3</sub>	b	b <sub>3</sub>	t						
[mm]											
<b>with keyway, without cylindrical handle</b>											
140	14	36	16.5	19	36	5	16.3	406	24610.0115		

### Compliance

#### RoHS compliant

Contains lead - compliant according to exceptions 6a / 6b / 6c

#### Contains SVHC substances >0,1% w/w

Contains lead - SVHC list [REACH] as of 10.06.2022

#### Contains Proposition 65 substances



Lead can cause cancer and reproductive harm from exposure  
<https://www.P65Warnings.ca.gov/>

#### Free from Conflict Minerals

This product does not contain any substances designated as "conflict minerals" such as tantalum, tin, gold or tungsten from the Democratic Republic of Congo or adjacent countries.