

Crank Handles · DIN 469 straight with square end DIN 79 24330.0170

Product Description

With these crank handles, the seam is ground and blasted. The hub is machined.



Material

Machine handle

- Steel, turned, zinc-plated by galvanization, passivated

Handle body

- Nodular cast iron, plastic coated, black

Drawing

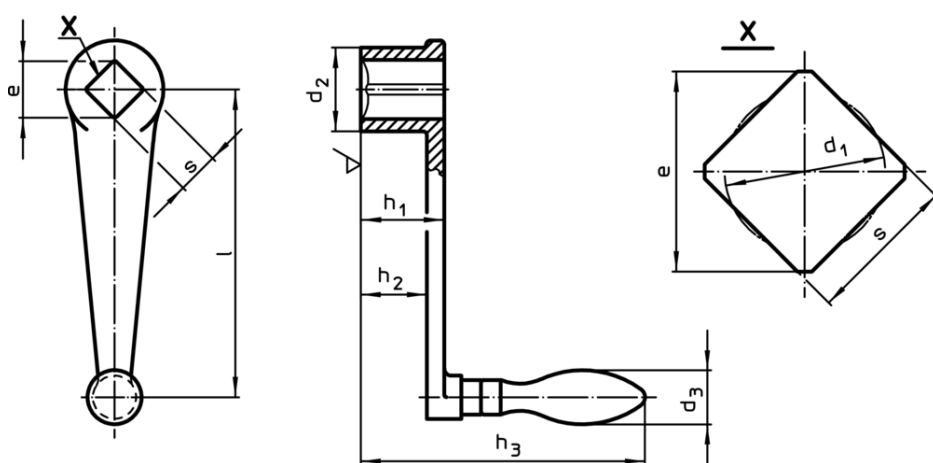

Order information

l	s H11	e min.	Dimensions					d ₃ Machine handle Ø	[g]	Art. No.
			d ₁ [mm]	d ₂	h ₁	h ₂ ~	h ₃			
with fixed machine handle (EH 24450., DIN 39), form F										
250	22	28.2	23.1	48	48	36	157	32	1360	24330.0170

Compliance

RoHS compliant

Contains lead - compliant according to exceptions 6a / 6b / 6c

Contains SVHC substances >0,1% w/w

Contains lead - SVHC list [REACH] as of 10.06.2022

Contains Proposition 65 substances



Lead can cause cancer and reproductive harm from exposure

<https://www.P65Warnings.ca.gov/>

Free from Conflict Minerals

This product does not contain any substances designated as "conflict minerals" such as tantalum, tin, gold or tungsten from the Democratic Republic of Congo or adjacent countries.