

Quick Plug Couplings · with radial offset compensation

25100.0006

Product Description

Quick plug coupling with radial offset compensation for multiple applications, e.g. as a link between a piston rod and a linear movement unit.



Material

Claw

- Heat-treated steel, tempered, phosphated

Coupling part

- Heat-treated steel, tempered, phosphated

Lock nut

- Steel, black (ISO 4035/8675)

Assembly

Assembly and disassembly of this simple, solid and two-part coupling is by means of a T-slot; a manual re-adjustment is not necessary. The quick plug coupling can be linked to all commonly used pneumatic and hydraulic lifting cylinders via the connecting thread.

More information

Notes

The quick plug coupling does not transmit any torque.

Drawing

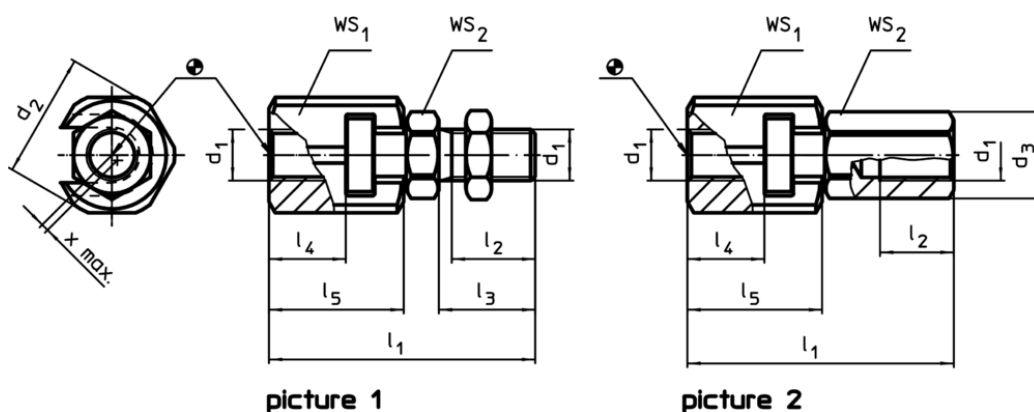

picture 1

picture 2

Order information

d ₁	d ₂	Dimensions					WS		Radial offset compensation x max. [mm]	Maximum tensile and compressive load max. [kN]	[g]	Art. No.
		l ₁ ~ [mm]	l ₂ min. [mm]	l ₃ [mm]	l ₄ min. [mm]	l ₅ [mm]	WS ₁ [mm]	WS ₂ [mm]				
with coupling screw – picture 1												
M6	21	37.5	11	14	9	18	19	10	0.6	2.5	44	25100.0006

Application example

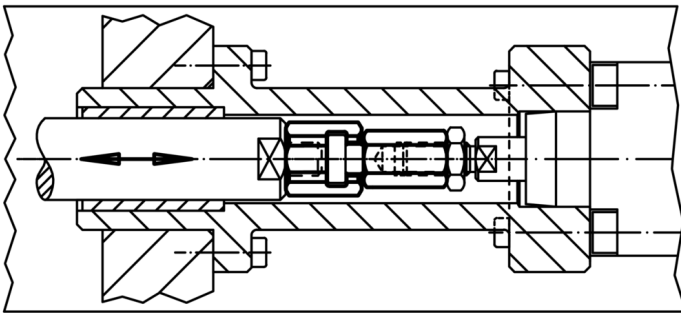
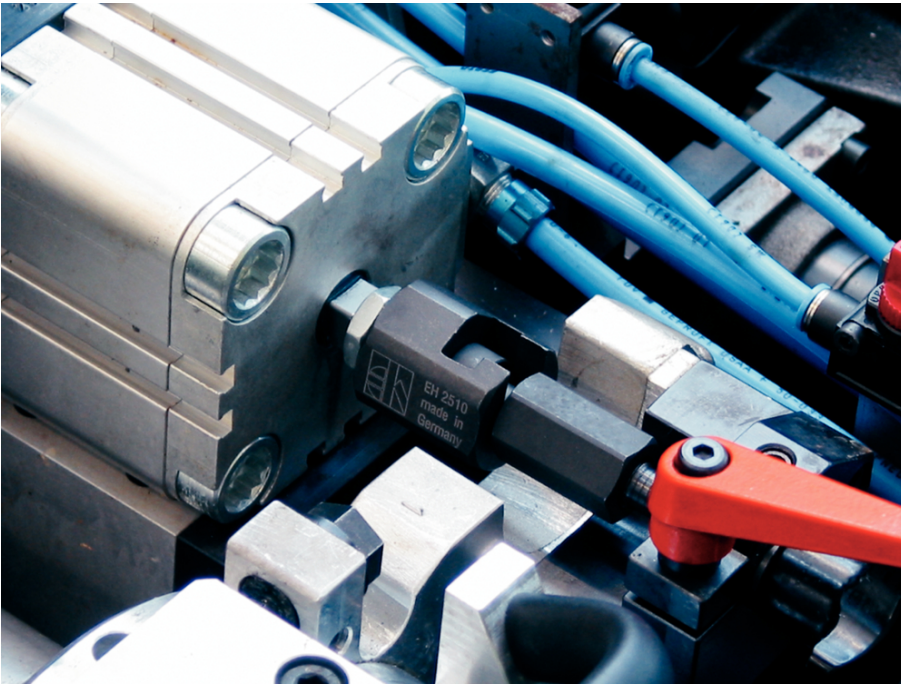

Compliance

RoHS compliant

Compliant according to Directive 2011/65/EU and Directive 2015/863

Does not contain SVHC substances

No SVHC substances with more than 0.1% w/w contained - SVHC list [REACH] as of 10.06.2022

Does not contain Proposition 65 substances

No Proposition 65 substances included
<https://www.P65Warnings.ca.gov/>

Free from Conflict Minerals

This product does not contain any substances designated as "conflict minerals" such as tantalum, tin, gold or tungsten from the Democratic Republic of Congo or adjacent countries.