

Series SMA – coaxial connectors

Description

HUBER+SUHNER SMA connectors are precision connectors for microwave applications up to 18 GHz. The extended frequency version operates with excellent return loss performances up to 26.5 GHz. There is a huge variety of applications for HUBER+SUHNER SMA connectors, as in telecom, test+measurement, instruments, avionics, etc.

The HUBER+SUHNER series SMA is classified into two categories:

- HUBER+SUHNER standard SMA connectors for high end applications or applications subject to rough conditions.
- HUBER+SUHNER ECO SMA connectors for high volume applications.

Content

Description	171
Interface dimensions in mm/inches	171
Features	171
Technical data	172
Cable connectors	175
Receptacles	191
PCB connectors	199
Protective caps and shorts	201

Interface dimensions (mm/inches)

Plug (male)

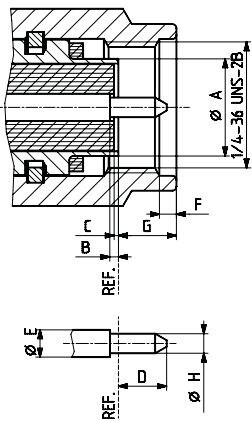

Jack (female)

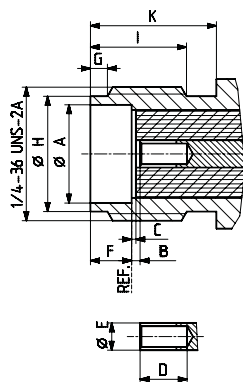

	Plug		Jack	
	min.	max.	min.	max.
A	-	4.59/1.81	4.59/0.181	-
B	0.00/0.000	0.25/0.010	0.00/0.000	0.25/0.010
C	0.00/0.000	0.25/0.010	0.00/0.000	0.25/0.010
C	-	2.54/0.100	2.67/0.105	-
E	1.24/0.049	1.29/0.051	1.24/0.049	1.29/0.051
F	0.38/0.015	1.14/0.045	1.88/0.074	1.98/0.078
G	-	3.43/0.135	0.38/0.015	1.14/0.045
H	0.90/0.036	0.94/0.037	5.28/0.208	5.49/0.216
I	-	-	4.32/0.170	-
K	-	-	5.54/0.218	-

Features

- Frequency range up to 18 GHz, extended frequency version up to 26.5 GHz
- Excellent return loss
- Intermateable with PC3.5 and SK
- The SMA (subminiature A) interface dimensions conform to the following standards:
 - International: IEC 60169-15
 - Europe: CECC 22110
 - USA: MIL-PRF-39012 SMA
 - Interface MIL-STD-348/310

Series SMA – technical data

Electrical data	MIL-C-39012				
Impedance		50 Ω			
Frequency range for interface		DC to 18 GHz (extended range DC to 26.5 GHz)			
RL (typical value)		for cable connectors refer to table below			
Cable type		semi-rigid		flexible	
Cable dielectric diameter (mm/in)		1.5/0.066	3/0.117	1.5/0.066	3/0.117
RF leakage measured at 3 GHz	3.26	≥ 100 dB-f (GHz)		≥ 60 dB	
Dielectric withstanding voltage (at sea level, in V rms, 50 Hz)	3.17	1000	1500	750	1000
Working voltage (at sea level, in V rms, 50 Hz)		335	500	250	335
Corona extinction voltage (at 21 000 m/70 000 ft, in V rms, 50 Hz)	3.22	250	375	190	250
Working voltage (at 21 000 m/70 000 ft, in V rms, 50 Hz)		85	125	65	85
RF withstanding voltage at 5 MHz (V rms)	3.23	670	1000	500	670
Insulation resistance	3.11	≥ 5 · 10 ³ MΩ			
Contact resistance • Centre contact • Outer contact	3.16	≤ 3 mΩ ≤ 2.5 mΩ			

Typical RL for HUBER+SUHNER standard SMA cable connectors

Typical RL (dB)	Frequency range					Cable group
	1 GHz	2.5 GHz	5 GHz	12.4 GHz	18 GHz	
Straight connectors	37	37	37	29	28	Y3, Y11
	37	37	34	29	23	Y5, Y12
	32	29	28			U2, U4
	34	32	29			U7, U9
Right angle connectors	37	32	26	19		Y3, Y11
	37	32	28	22		Y5, Y12
	32	29	26			U2, U4
	37	32	29			U7, U9

Series SMA – technical data

Typical RL for HUBER+SUHNER ECO SMA cable connectors

Typical RL (dB)	Frequency range				Cable group
	1 GHz	2.5 GHz	5 GHz	6 GHz	
Connector type					
Straight connectors	36	36	35	30	Y3, Y11
	36	36	35	30	Y5, Y12
	32	29	26	25	U2, U4
	34	32	27	25	U7, U9
Right angle connectors	36	32	26	25	Y3, Y11
	36	32	28	24	Y5, Y12
	32	29	26	25	U2, U4
	36	32	26	25	U7, U9

Mechanical data	MIL-C-39012		
Recommended coupling nut torque		HUBER+SUHNER standard SMA	0.8 to 1.1 Nm (7.1 to 9.7 in lbs)
		HUBER+SUHNER ECO SMA	0.45 Nm (4.0 in lbs)
Coupling nut retention force	3.25		≥ 270 N/60.7 lbs
Contact captivation • Axial	3.12	HUBER+SUHNER standard SMA	≥ 27 N/6.1 lbs
		HUBER+SUHNER ECO SMA	≥ 20 N/5.4 lbs
Cable retention force ¹⁾		see suitable cables, pages 32 – 37	
Durability (matings)			≤ 500

Environmental data	Test conditions
Temperature range	–65 to +165°C / –85 to +329 °F
Climatic category	IEC → 55/155/21
Thermal shock	MIL-STD-202, method 107, condition B
Moisture resistance	MIL-STD-202, method 106
Corrosion	saltspray test acc. to MIL-STD-202, method 101, condition B
Vibration	MIL-STD-202, method 204, condition D
Shock	MIL-STD-202, method 213, condition I
	Except the hermetic sealed SMA connectors all other connector types satisfy RoHS compatibility.

¹⁾ Value considers maximum load of the cables without irreversible variations of specifications.

Series SMA – technical data

Material data			
Connector part		Material	Plating
Bodies, outer contacts, nut	HUBER+SUHNER standard SMA	copper-beryllium alloy stainless steel, spring bronze	gold, passivated
	HUBER+SUHNER ECO SMA	brass, spring bronze	SUCOPLATE®/ SUCOPRO® gold plating
Pin contacts		copper-beryllium alloy, brass	gold/SUCOPRO® gold plating
Socket contacts		copper-beryllium alloy/spring bronze	gold
Crimp ferrules		copper, brass	gold
Insulators		PTFE or PFA	
Gaskets		silicone rubber	

HUBER+SUHNER SMA connectors satisfy in principle the above technical data. For detailed specifications refer to the published data sheets on our webpage www.hubersuhner.com.

Series SMA – cable connectors

Straight cable plugs (male)

For semi-rigid cables

- With pin and insulator
- Cable entry soldered
- Centre contact soldered

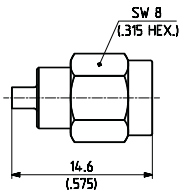

Fig. 1

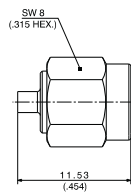

Fig. 2

HUBER+SUHNER type	Item no.	Cable group (example)	Packaging	Assembly instruction	Plating body	Fig.	Notes
11_SMA-50-1-1/111_NE ¹⁾²⁾	22642387	Y19 (EZ_34)	single	9118	gold	1	
11_SMA-50-1-2/111_NE ¹⁾²⁾	22642388	Y2, Y15 (SUCOFORM_47, EZ_47)	single	9119		1	
11_SMA-50-1-53/119_NH	23013327	Y2, Y15 (SUCOFORM_47, EZ_47)	bulk 100 pcs.	150006		2	nut passivated stainless steel

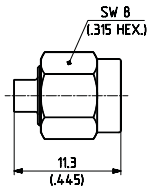

Fig. 1

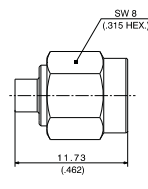

Fig. 2



HUBER+SUHNER type	Item no.	Cable group (example)	Packaging	Assembly instruction	Plating body	Fig.	Notes
11_SMA-50-2-15/111_NE ⁵⁾	22544545	Y3, Y11, Y16 (SUCOFORM_86, EZ_86)	single	9056	gold	1	
11_SMA-50-2-15/111_NH	22645898		bulk 100 pcs.				
11_SMA-50-2-65/119_NE ^{3) 5)}	22642315	Y3, Y11, Y16 (SUCOFORM_86, EZ_86)	single	9056	gold	1	nut passivated stainless steel
11_SMA-50-2-65/119_NH ³⁾	22645366		bulk 100 pcs.				
11_SMA-50-2-110/133_NE ⁴⁾	84130715	Y3, Y11, Y16 (SUCOFORM_86, EZ_86)	single	0000349249	SUCO-PLATE®	2	
11_SMA-50-2-110/133_NP ⁴⁾	84117816		bulk 500 pcs.				

All highlighted types are HUBER+SUHNER ECO types.

¹⁾ Compound 74_Z-0-0-116 needed

²⁾ SUCOPRO® (economical) version on request

³⁾ Cable entry CuBe/gold

⁴⁾ Use torque wrench 74_Z-0-0-79

⁵⁾ SUCOPRO® (economical) version on request

Series SMA – cable connectors

Straight cable plugs (male)

For semi-rigid cables

- With pin and insulator
- Cable entry soldered
- Centre contact soldered

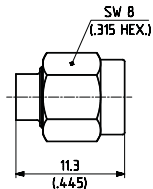

Fig. 1

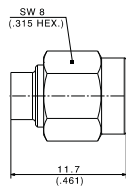

Fig. 2

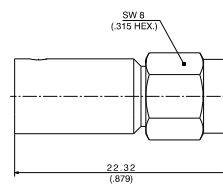

Fig. 3



HUBER+SUHNER type	Item no.	Cable group (example)	Packaging	Assembly instruction	Plating body	Fig.	Notes
11_SMA-50-3-15/111_NE ²⁾ 11_SMA-50-3-15/111_NH	22544547 22651601	Y5, Y12, Y17 (SUCOFORM_141, EZ_141)	single bulk 100 pcs.	9056	gold	1	
11_SMA-50-3-65/119_NE 11_SMA-50-3-65/119_NH	22641643 22646570	Y5, Y12, Y17 (SUCOFORM_141, EZ_141)	single bulk 100 pcs.	9056	gold	1	nut passivated stainless steel
11_SMA-50-3-235/133_NE ¹⁾ 11_SMA-50-3-235/133_NP ¹⁾	84130698 84104274	Y5, Y12, Y17 (SUCOFORM_141, EZ_141)	single bulk 500 pcs.	0000333508	SUCO-PLATE®	2	
11_SMA-50-5-1/111_NE ²⁾	22642399	Y7, Y14 (SUCOFORM_250_01, EZ_250)	single	0000181414	gold	3	

All highlighted types are HUBER+SUHNER ECO types.

26.5 GHz – straight cable plugs (male)

For semi-rigid cables

- With pin and insulator
- Centre contact soldered

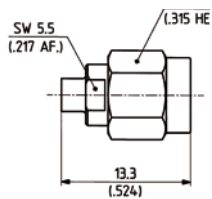

Fig. 1

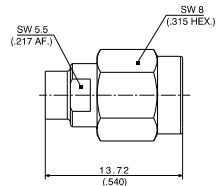
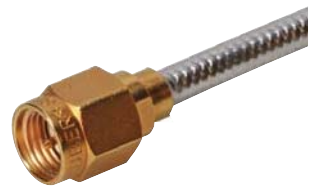

Fig. 2



HUBER+SUHNER type	Item no.	Cable group (example)	Packaging	Assembly instruction	Fig.	Plating body
11_SMA-50-2-100/111_NE ²⁾	22648717	Y3, Y11, (SUCOFORM_86, EZ_86)	single	0000181590	1	gold
11_SMA-50-3-100/111_NE ²⁾ 11_SMA-50-3-100/111_NH	22648718 22658936	Y5, Y12, Y17 (SUCOFORM_141, EZ_141)	single bulk 100 pcs.		2	

¹⁾ Use torque wrench 74_Z-0-0-79

²⁾ SUCOPRO® (economical) version on request

Series SMA – cable connectors

26.5 GHz – straight cable plugs (male)

- For semi-rigid cables
- Without pin and insulator

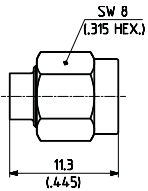

Fig. 1

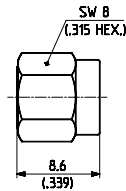
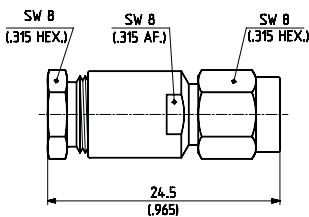

Fig. 2

HUBER+SUHNER type	Item no.	Cable group (example)	Packaging	Assembly instruction	Plating body	Fig.	Notes
11_SMA-50-3-14/-11_NH	22644467	Y5 (EZ_141)	bulk 100 pcs.	9055	gold	1	
11_SMA-50-3-16/-11_NH	22644470		bulk 100 pcs.		gold	2	
11_SMA-50-3-42/-33_NE	22649222		single		SUCOPLATE®	2	
11_SMA-50-3-42/-33_NH	22646128		bulk 100 pcs.				
11_SMA-50-3-64/-19_NH	22649224		bulk 100 pcs.		gold	1	nut passivated stainless steel
11_SMA-50-3-66/-19_NE	22641644	single bulk 100 pcs.	gold	2	nut passivated stainless steel		
11_SMA-50-3-66/-19_NH	22645207						

Straight cable plugs (male)

- For flexible cables
- Cable entry clamp
 - Centre contact soldered



HUBER+SUHNER type	Item no.	Cable group (example)	Packaging	Assembly instruction	Plating body
11_SMA-50-3-7/111_NE ¹⁾	22640050	U7 (RG_58_C/U)	single	3071	gold
11_SMA-50-3-8/111_NH ¹⁾	22648630	U9 (EF_142, RG_142)	bulk 100 pcs.		
11_SMA-50-3-10/111_NE ¹⁾	22640053	U11 (EF_400, RG_400_/U)	single		

¹⁾ SUCOPRO® (economical) version on request

Series SMA – cable connectors

Straight cable plugs (male)

For flexible cables

- Cable entry crimp
- Centre contact soldered

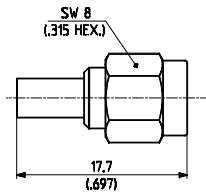

Fig. 1

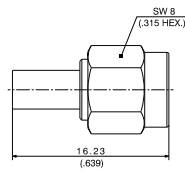

Fig. 2



HUBER+SUHNER type	Item no.	Cable group (example)	Packaging	Assembly instruction	Plating body	Crimp insert	Fig.
11_SMA-50-1-4/111_NE ³⁾	22645871	U1 (EF_178, RG_178_B/U)	single	27061	gold	A	1
11_SMA-50-2-5/111_NE ³⁾ 11_SMA-50-2-5/111_NH	22640042 22646312	U2 (EF_316, RG_316_/U)	single bulk 100 pcs.	27266	gold	A	1
11_SMA-50-2-6/111_NE ³⁾ 11_SMA-50-2-6/111_NH	22640043 22650740	U4 (EF_316_D, K_02252_D)	single bulk 100 pcs.	27266	gold	A	1
11_SMA-50-2-27/111_NE ^{1), 3)} 11_SMA-50-2-27/111_NH ¹⁾	84022967 22652923	U2 (EF_316, RG_316_/U)	single bulk 100 pcs.	27164	gold	1 A	1
11_SMA-50-2-55/199_NE	22641377	U2 (EF_316, RG_316_/U)	single	3069	passivated stainless steel	A	1
11_SMA-50-2-56/199_NE 11_SMA-50-2-56/199_NH	22641376 22651486	U4 (EF_316_D K_02252_D)	single bulk 100 pcs.	3069	passivated stainless steel	A	1
11_SMA-50-2-111/133_NE ²⁾ 11_SMA-50-2-111/133_NP ²⁾	84130699 84117820	U2 (EF_316, RG_316_/U, RG_174)	single bulk 500 pcs.	0000348839	SUCOPLATE®	A	2
11_SMA-50-2-112/133_NE ²⁾ 11_SMA-50-2-112/133_NP ²⁾	84130700 84115820	U4 (EF_316_D)	single bulk 500 pcs.	0000347891	SUCOPLATE®	A	2

All highlighted types are HUBER+SUHNER ECO types.

¹⁾ HUBER+SUHNER full crimp

²⁾ use torque wrench 74_Z.0-0-79

³⁾ SUCOPRO® (economical) version on request

Series SMA – cable connectors

Straight cable plugs (male)

For flexible cables

- Cable entry crimp
- Centre contact soldered

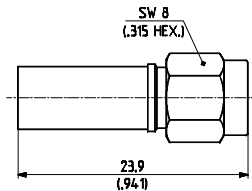

Fig. 1

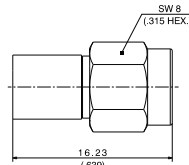

Fig. 2

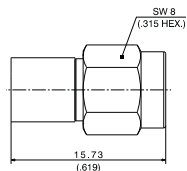

Fig. 3

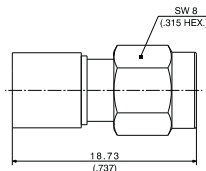

Fig. 4

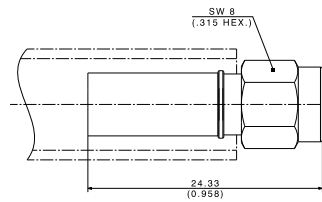

Fig. 5

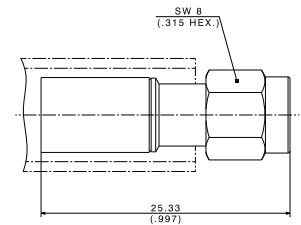

Fig. 6

HUBER+SUHNER type	Item no.	Cable group (example)	Packaging	Assembly instruction	Plating body	Crimp insert	Fig.
11_SMA-50-3-5/111_NE ²⁾ 11_SMA-50-3-5/111_NH	22640048 22644684	U7 (RG_58_C/U)	single bulk 100 pcs.	3069	gold	B	1
11_SMA-50-3-6/111_NE ²⁾ 11_SMA-50-3-6/111_NH	22640049 22650739	U9, U11 (EF_142, RG_400_/U)	single bulk 100 pcs.	3069	gold	B	1
11_SMA-50-3-55/199_NE	22641371	U7 (RG_58_C/U)	single	3069	passivated stainless steel	B	1
11_SMA-50-3-56/199_NE 11_SMA-50-3-56/199_NH	22543647 22648300	U9, U11 (EF_142, RG_400_/U)	single bulk 100 pcs.	3069	passivated stainless steel	B	1
11_SMA-50-3-236/133_NE ¹⁾ 11_SMA-50-3-236/133_NP ¹⁾	84130702 84117821	U9, U11, U41 (EF_142, RG_400_/U)	single bulk 500 pcs.	0000349507	SUCOPLATE®	1 ³⁾	2
11_SMA-50-3-237/133_NE ¹⁾ 11_SMA-50-3-237/133_NP ¹⁾	84130709 84117823	U7 (RG_58_C/U)	single bulk 500 pcs.	0000349571	SUCOPLATE®	B	3
11_SMA-50-3-239/133_NF	85010668	X27 (SPUMA_195)	single	0000417562	SUCOPLATE®	B	5
11_SMA-50-4-50/133_NE ¹⁾ 11_SMA-50-4-50/133_NP ¹⁾	84130705 84112519	S16, X9 (S_04262_D)	single bulk 500 pcs.	0000347768	SUCOPLATE®	2 ⁴⁾	4
11_SMA-50-4-77/133_NE	85010193	X28 (SPUMA_240)	single	0000416855	SUCOPLATE®	C	6

All highlighted types are HUBER+SUHNER ECO types.

¹⁾ Use torque wrench 74_Z0-0-79

²⁾ SUCOPRO® (economical) version on request

³⁾ Crimp tool 76_Z0-0-57

⁴⁾ Crimp tool 76_Z0-4-23

Series SMA – cable connectors

Right angle cable plugs (male)

For semi-rigid cables

- With pin and insulator
- Cable entry soldered
- Centre contact soldered

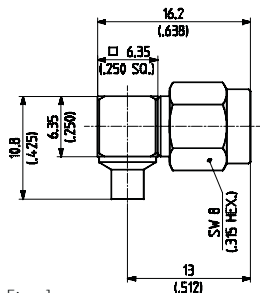

Fig. 1

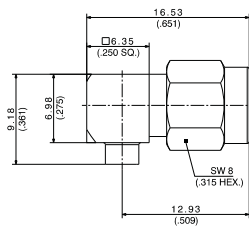

Fig. 2



HUBER+SUHNER type	Item no.	Cable group (example)	Packaging	Assembly instruction	Plating body	Fig.	Notes
16_SMA-50-2-53/119_NE	22644242	Y3, Y11, Y16	single	3068	gold	1	nut passivated stainless steel
16_SMA-50-2-53/119_NH	22646639	(SUCOFORM_86, EZ_86)	bulk 100 pcs.				
16_SMA-50-2-103/111_NE ²⁾	84018309	Y3, Y11, Y16	single	3068	gold	1	
16_SMA-50-2-103/111_NH	22652924	(SUCOFORM_86, EZ_86)	bulk 100 pcs.				
16_SMA-50-2-110/133_NE ¹⁾	84130706	Y3, Y11, Y16	single	0000335631	SUCO-PLATE®	2	
16_SMA-50-2-110/133_NP ¹⁾	84117807	(SUCOFORM_86, EZ_86)	bulk 500 pcs.				

All highlighted types are HUBER+SUHNER ECO types.

- With pin and insulator
- Cable entry soldered
- Centre contact soldered

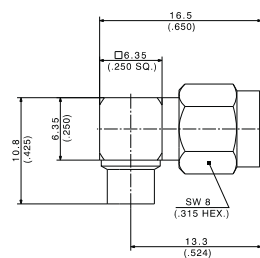

Fig. 1

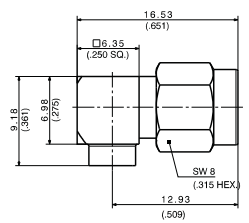

Fig. 2



HUBER+SUHNER type	Item no.	Cable group (example)	Packaging	Assembly instruction	Plating body	Fig.	Notes
16_SMA-50-3-3/111_NE ²⁾	22640073	Y5, Y12, Y17	single	3068	gold	1	
16_SMA-50-3-3/111_NH	22646569	(SUCOFORM_141, EZ_141)	bulk 100 pcs.				
16_SMA-50-3-13/133_NE ¹⁾	84130707	Y5, Y12, Y17	single	0000335642	SUCO-PLATE®	2	
16_SMA-50-3-13/133_NP ¹⁾	84117810	(SUCOFORM_141, EZ_141)	bulk 500 pcs.				
16_SMA-50-3-53/119_NE	22644243	Y5, Y12, Y17	single	3068	gold	1	nut passivated stainless steel
16_SMA-50-3-53/119_NH	22646561	(SUCOFORM_141, EZ_141)	bulk 100 pcs.				

All highlighted types are HUBER+SUHNER ECO types.

¹⁾ Use torque wrench 74_Z-0-0-79

²⁾ SUCOPRO® (economical) version on request

Series SMA – cable connectors

26.5 GHz – right angle cable plugs (male)

For semi-rigid cables

- With pin and insulator
- Cable entry soldered
- Centre contact plugged

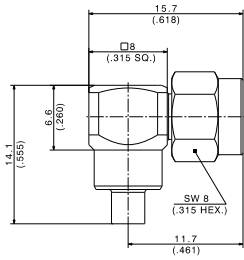

Fig. 1

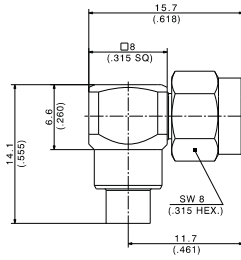

Fig. 2



HUBER+SUHNER type	Item no.	Cable group (example)	Packaging	Assembly instruction	Plating body	Fig.
16_SMA-50-2-100/199_NH	23018813	Y3, Y11, Y16 (SUCOFORM_86, EZ_86)	bulk 100 pcs.	27055	passivated stainless steel	1
16_SMA-50-3-100/199_NE	22648293	Y5, Y12, Y17 (SUCOFORM_141, EZ_141)	single			2

Series SMA - cable connectors

Right angle cable plugs (male)

For flexible cables

- Cable entry crimp
- Centre contact soldered

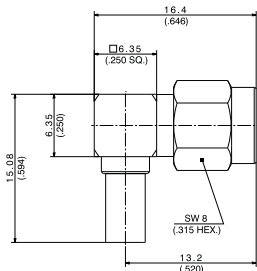

Fig. 1

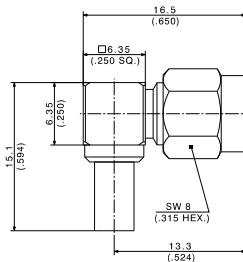

Fig. 2

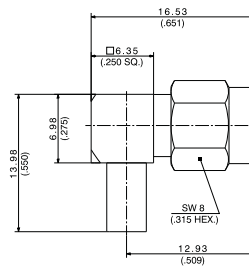

Fig. 3



HUBER+SUHNER type	Item no.	Cable group (example)	Packaging	Assembly instruction	Plating body	Crimp insert	Fig.
16_SMA-50-1-1/111_NE ²⁾ 16_SMA-50-1-1/111_NH	22641805 22660358	U1 (EF_178, RG_178_B/U)	single bulk 100 pcs.	3070	gold	A	1
16_SMA-50-2-55/199_NE 16_SMA-50-2-55/199_NH	22642661 84028953	U2 (EF_316, RG_316_/U)	single bulk 100 pcs.	3070	passivated stainless steel		2
16_SMA-50-2-56/199_NE 16_SMA-50-2-56/199_NH	22642662 22658888	U4 (EF_316_D, K_02252_D)	single bulk 100 pcs.	3070	passivated stainless steel		2
16_SMA-50-2-105/111_NE ²⁾ 16_SMA-50-2-105/111_NH	22651455 22651456	U2 (EF_316, RG_316_/U)	single bulk 100 pcs.	3070	gold		1
16_SMA-50-2-106/111_NE ²⁾ 16_SMA-50-2-106/111_NH	22651457 22651458	U4 (EF_316_D, K_02252_D)	single bulk 100 pcs.	3070	gold		1
16_SMA-50-2-111/133_NE ¹⁾ 16_SMA-50-2-111/133_NP ¹⁾	84130708 84117808	U2 (EF_316, RG_316_/U)	single bulk 500 pcs.	0000335656	SUCOPLATE®		3
16_SMA-50-2-112/133_NE ¹⁾ 16_SMA-50-2-112/133_NP ¹⁾	84130709 84117809	U4 (EF_316_D, K_02252_D)	single bulk 500 pcs.	0000335656	SUCOPLATE®		3

All highlighted types are HUBER+SUHNER ECO types.

¹⁾ Use torque wrench 74_Z-0-0-79

²⁾ SUCOPRO® (economical) version on request

Series SMA – cable connectors

Right angle cable plugs (male)

For flexible cables

- Cable entry crimp
- Centre contact soldered



SMA

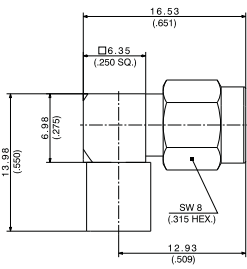

Fig. 1

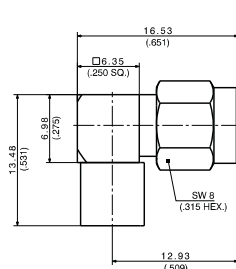

Fig. 2

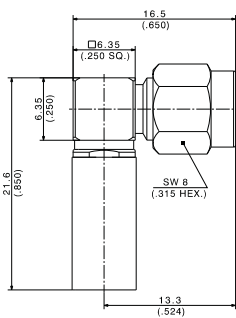

Fig. 3

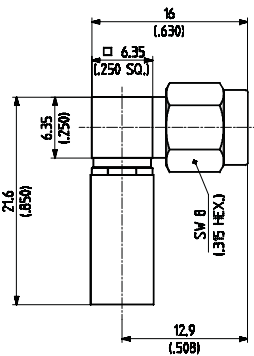

Fig. 4

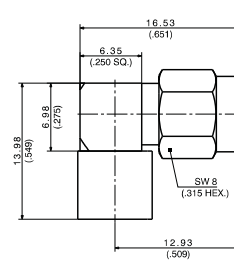

Fig. 5

HUBER+SUHNER type	Item no.	Cable group (example)	Packaging	Assembly instruction	Plating body	Crimp insert	Fig.
16_SMA-50-3-14/133_NE ¹⁾	84130711	U9, U11, U41 (EF_142)	single	0000335678	SUCOPLATE®	B	1
16_SMA-50-3-14/133_NP ¹⁾	84117811		bulk 500 pcs.				
16_SMA-50-3-15/133_NE ¹⁾	84130712	U7 (RG_58)	single	0000335679	SUCOPLATE®	B	2
16_SMA-50-3-15/133_NP ¹⁾	84117812		bulk 500 pcs.				
16_SMA-50-3-56/199_NE	22642660	U9, U11 (EF_142, RG_400_/U, RG_223)	single	3070	passivated stainless steel	B	3
16_SMA-50-3-105/111_NE ²⁾	22651585	U7 (RG_58)	single	3070	gold	B	4
16_SMA-50-3-105/111_NH	22651800		bulk 100 pcs.				
16_SMA-50-3-106/111_NE ²⁾	22650546	U9, U11 (EF_142, RG_400_/U, RG_223))	single	3070	gold	B	4
16_SMA-50-3-106/111_NH	22650545		bulk 100 pcs.				
16_SMA-50-4-50/133_NE ¹⁾	84130714	S16, X9 (S_04262_D)	single	0000335684	SUCOPLATE®	C	5
16_SMA-50-4-50/133_NP ¹⁾	84117813		bulk 500 pcs.				

All highlighted types are HUBER+SUHNER ECO types.

¹⁾ Use torque wrench 74_Z-0-0-79

²⁾ SUCOPRO® (economical) version on request

Series SMA – cable connectors

Straight cable jacks (female)

For semi-rigid cables

- Cable entry soldered
- Centre contact soldered

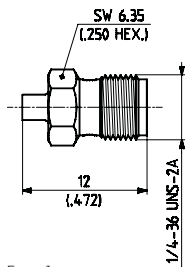

Fig. 1

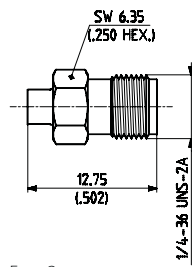

Fig. 2

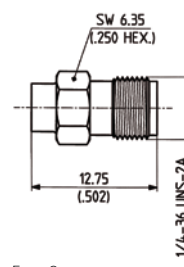

Fig. 3



HUBER+SUHNER type	Item no.	Cable group (example)	Packaging	Assembly instruction	Plating body	Fig.
21_SMA-50-1-1/111_NE ¹⁾	22642385	Y19 (EZ_34)	single	9118	gold	1
21_SMA-50-1-2/111_NE	22642386	Y2, Y15 (SUCOFORM_47, EZ_47)	single	9119		1
21_SMA-50-2-15/111_NE ¹⁾	22544549	Y3, Y11, Y16 (SUCOFORM_86, EZ_86)	single	9057		2
21_SMA-50-2-15/111_NH	22652141		bulk 100 pcs.			
21_SMA-50-3-15/111_NE ¹⁾	22544550	Y5, Y12, Y17 (SUCOFORM_141, EZ_141)	single	9057		3
21_SMA-50-3-15/111_NH	22645042		bulk 100 pcs.			

¹⁾ SUCOPRO® (economical) version on request

Series SMA – cable connectors

Straight cable jacks (female)

For flexible cables

- Cable entry crimp
- Centre contact soldered

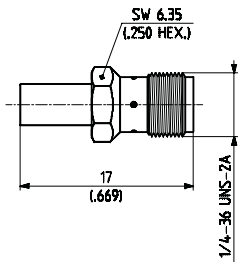

SMA

HUBER+SUHNER type	Item no.	Cable group (example)	Packaging	Assembly instruction	Plating body	Crimp insert
21_SMA-50-2-5/111_NE ¹⁾	22640077	U2 (EF_316, RG_316_/U)	single	3069	gold	A
21_SMA-50-2-6/111_NE ¹⁾ 21_SMA-50-2-6/111_NH	22640078 22651818	U4 (EF_316_D, K_02252_D)	single bulk 100 pcs.			

- Cable entry crimp
- Centre contact soldered

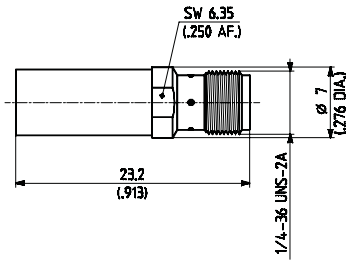

HUBER+SUHNER type	Item no.	Cable group (example)	Packaging	Assembly instruction	Plating body	Crimp insert
21_SMA-50-3-5/111_NE ¹⁾	22640081	U7 (RG_58_C/U)	single	3069	gold	B
21_SMA-50-3-6/111_NE ¹⁾	22640082	U9, U11, U39 (EF_142, RG_400_/U)				

¹⁾ SUCOPRO® (economical) version on request

Series SMA - cable connectors

Straight bulkhead cable jacks (female)

For semi-rigid cables

- Cable entry soldered
- Centre contact soldered
- With panel seal

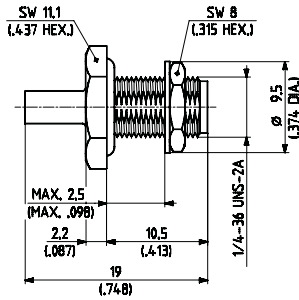

Fig. 1

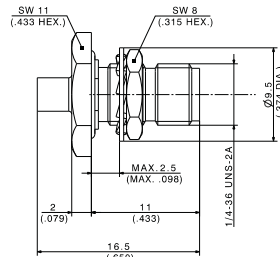

Fig. 2

HUBER+SUHNER type	Item no.	Cable group (example)	Packaging	Assembly instruction	Plating body	Mounting hole	Fig.
24_SMA-50-2-15/111_NE ¹⁾ 24_SMA-50-2-15/111_NH	22544532 22645490	Y3, Y11, Y16 (SUCOFORM_86)	single bulk 100 pcs.	9057	gold	ML 35	1
24_SMA-50-2-41/133_NE 24_SMA-50-2-41/133_NH	22641381 22645368	Y3, Y11, Y16 (SUCOFORM_86)	single bulk 100 pcs.	0000185051	SUCOPLATE®	ML 20	2

All highlighted types are HUBER+SUHNER ECO types.

- Cable entry soldered
- Centre contact soldered
- With panel seal

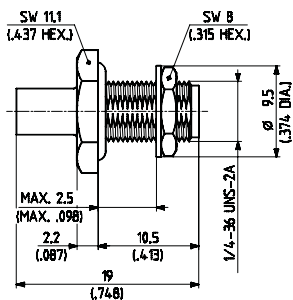

Fig. 1

HUBER+SUHNER type	Item no.	Cable group (example)	Packaging	Assembly instruction	Plating body	Mounting hole	Fig.
24_SMA-50-3-15/111_NE ¹⁾ 24_SMA-50-3-15/111_NH	22641153 22645259	Y5, Y12, Y17 (SUCOFORM_141, EZ_141)	single bulk 100 pcs.	9057	gold	ML 35	1

¹⁾ SUCOPRO® (economical) version on request

Series SMA – cable connectors

26.5 GHz – straight bulkhead cable jacks (female)

For semi-rigid cables

- Cable entry soldered
- Centre contact soldered

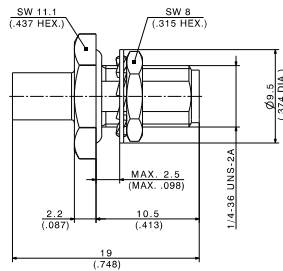
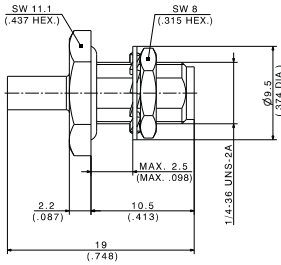

Fig. 1

Fig. 2

HUBER+SUHNER type	Item no.	Cable group (example)	Packaging	Assembly instruction	Plating body	Mounting hole	Fig.
24_SMA-50-2-100/111_NE ¹⁾	22648727	Y3, Y11, Y16 (SUCOFORM_86, EZ_86)	single	27055	gold	M1.35	1
24_SMA-50-3-100/111_NE ¹⁾	22648728	Y5, Y12, Y17 (SUCOFORM_141, EZ_141)	single				2

¹⁾ SUCOPRO® [economical] version on request

Series SMA – cable connectors

Straight bulkhead cable jacks (female)

For flexible cables

- Cable entry crimp
- Centre contact soldered

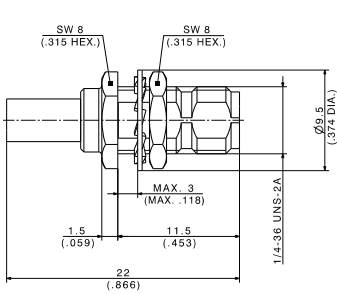

Fig. 1

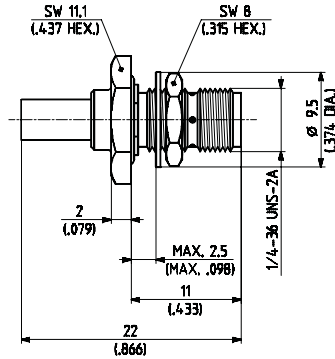

Fig. 2

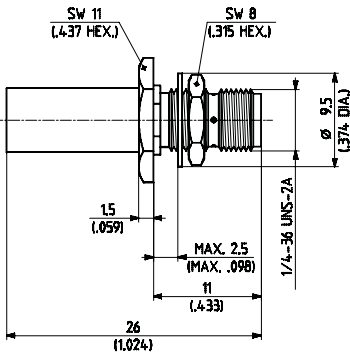

Fig. 4

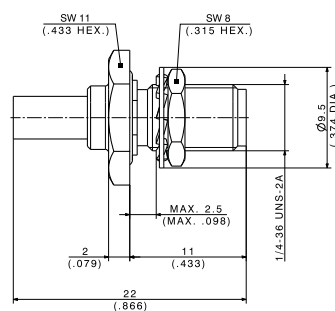

Fig. 5

HUBER+SUHNER type	Item no.	Cable group (example)	Packaging	Assembly instruction	Plating body	Crimp insert	Mounting hole	Fig.
24_SMA-50-1-3/111_NE ¹⁾	22649873	U1 (EF_178, RG_178)	single	27104	gold	A	ML 35	1
24_SMA-50-2-13/111_NE ¹⁾	22651767	U4 (EF_316_D, K_02252_D)	single	3069	gold	A	ML 20	2
24_SMA-50-2-13/111_NH	22651719		bulk 100 pcs.					
24_SMA-50-2-14/111_NE ¹⁾	22651748	U2 (EF_316, RG_316_/U)	single	3069	gold	A	ML 20	2
24_SMA-50-2-14/111_NH	22651747		bulk 100 pcs.					
24_SMA-50-2-37/133_NE	85013993	U4 (EF_316_D, K_02252_D)	single	3069	SUCOPLATE®	A	ML 20	4
24_SMA-50-2-37/133_NH	85013981		bulk 100 pcs.					
24_SMA-50-2-46/133_NE	22644246	U2 (EF_316, RG_316_/U)	single	3069	SUCOPLATE®	A	ML 20	2
24_SMA-50-2-46/133_NH	22646565		bulk 100 pcs.					
24_SMA-50-3-42/133_NE	22641358	U9 (EF_142, RG_223)	single	3072	SUCOPLATE®	B	ML 20	3

All highlighted types are HUBER+SUHNER ECO types.

¹⁾ SUCOPRO® (economical) version on request

Series SMA - cable connectors

Straight panel cable jacks (female)

For semi-rigid cables

- Cable entry soldered
- Centre contact soldered

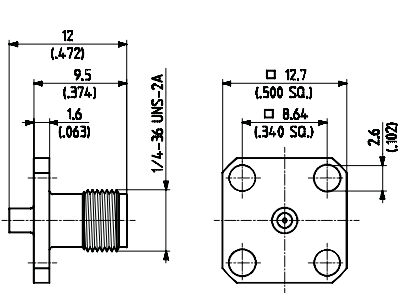

Fig. 1

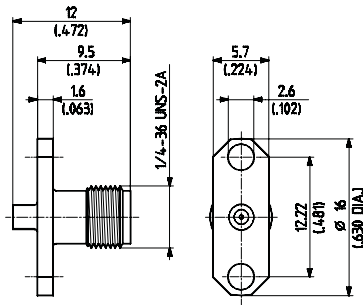

Fig. 2



SMA

HUBER+SUHNER type	Item no.	Cable group (example)	Packaging	Assembly instruction	Plating body	Mounting hole	Fig.
25_SMA-50-1-2/111_NE ²⁾	22642390	Y2, Y15 (SUCOFORM_47, EZ_47)	single	9119	gold	ML 19	1
25_SMA-50-1-4/111_NE ²⁾	22642391	Y2, Y15 (SUCOFORM_47, EZ_47)	single bulk 100 pcs.	9119		-	2
25_SMA-50-2-15/111_NE ¹⁾²⁾	22544551	Y3, Y11, Y16 (SUCOFORM_86, EZ_86)	single	9057		ML 19	1
25_SMA-50-2-25/111_NE ¹⁾²⁾	22641493	Y3, Y11, Y16 (SUCOFORM_86, EZ_86)	single	9057		-	2

¹⁾ Centre contact not captivated

²⁾ SUCOPRO® (economical) version on request

Series SMA - cable connectors

Straight panel cable jacks (female)

For semi-rigid cables

- Cable entry soldered
- Centre contact soldered

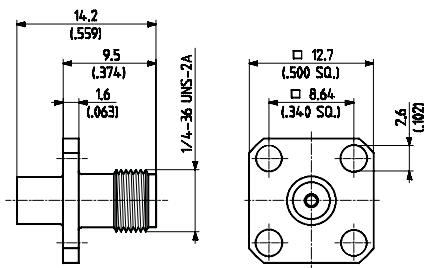

Fig. 1

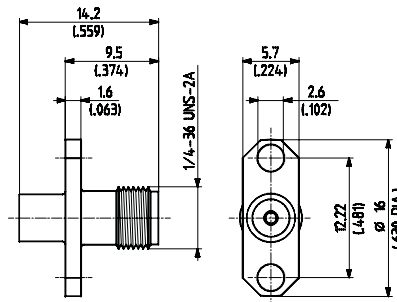
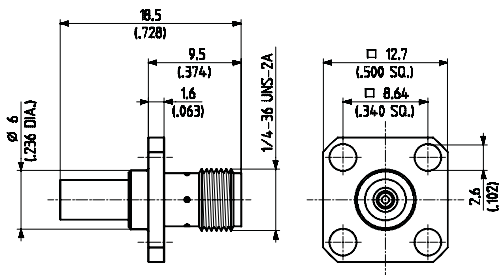

Fig. 2



HUBER+SUHNER type	Item no.	Cable group (example)	Packaging	Assembly instruction	Plating body	Mounting hole	Fig.
25_SMA-50-3-15/111_NE ¹⁾²⁾ 25_SMA-50-3-15/111_NH ¹⁾	22544552 22644717	Y5, Y12, Y17 (SUCOFORM_141, EZ_141)	single bulk 100 pcs.	9057	gold	ML 19	1
25_SMA-50-3-25/111_NE ¹⁾²⁾	22641410	Y5, Y12, Y17 (SUCOFORM_141, EZ_141)	single			-	2

- Cable entry crimp
- Centre contact soldered



HUBER+SUHNER type	Item no.	Cable group (example)	Packaging	Assembly instruction	Plating body	Mounting hole	Crimp insert
25_SMA-50-2-5/111_NE ²⁾ 25_SMA-50-2-5/111_NH	22640112 22650755	U2 (EF_316, RG_316_/U)	single bulk 100 pcs.	3072	gold	ML 19	A
25_SMA-50-2-6/111_NE ²⁾	22640113	U4 (EF_316_D, K_02252_/D)	single				
25_SMA-50-2-46/133_NE	22642246	U4 (EF_316_D, K_02252_/D)	single	3072	SUCOPLATE®	ML 19	A

All highlighted types are HUBER+SUHNER ECO types.

¹⁾ Centre contact not captivated

²⁾ SUCOPRO® (economical) version on request

Series SMA – receptacles

Straight bulkhead receptacles

With solder end, jacks (female)

- With panel seal

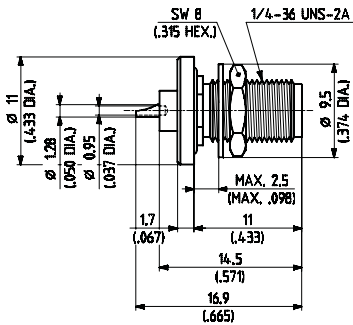

HUBER+SUHNER type	Item no.	Packaging	Plating body	Mounting hole	Mounting
22_SMA-50-0-1/111_NE	22640087	single	gold	ML 20	rear mounting

- Without panel seal

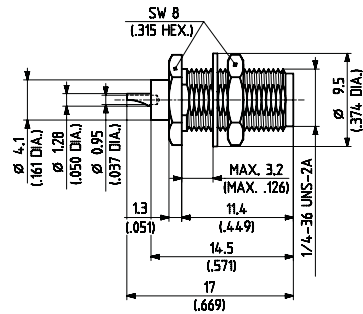

HUBER+SUHNER type	Item no.	Packaging	Plating body	Mounting hole	Mounting
22_SMA-50-0-4/111_NE	22640962	single	gold	ML 35	rear mounting
22_SMA-50-0-4/111_NH	22649418	bulk 100 pcs.	gold	ML 35	rear mounting

Series SMA - receptacles

Straight bulkhead receptacles

With coaxial end, jacks (female)

- Without panel seal

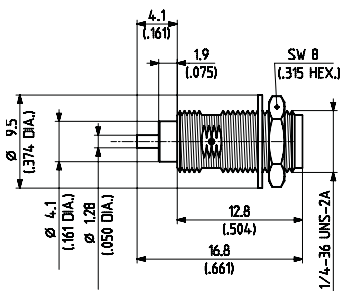

Fig. 1

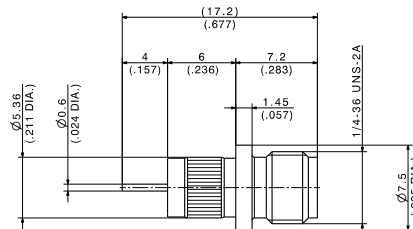

Fig. 2



HUBER+SUHNER type	Item no.	Packaging	Plating body	Mounting hole	Mounting	Fig.
22_SMA-50-0-3/111_NE	22640089	single	gold	ML 98	Front mounting	1
22_SMA-50-0-53/199_NE	22543498	single	passivated stainless steel			

Hermetically sealed, plug (male)

- "Spark plug" with metal ring seal
- RoHs compliant alternative on request
- Front mounting

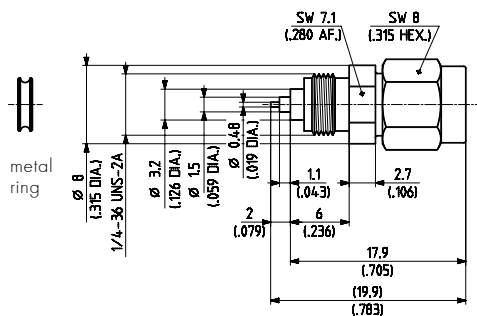

HUBER+SUHNER type	Item no.	Packaging	Plating body	Mounting hole	Notes
12_SMA-50-0-110/111_NE ¹⁾	22652315	single	gold	ML42	leak rate 10 ⁻⁸ Torr/l/sec

¹⁾ Use assembly tool 74_Z-0-0-75 and torque wrench 74_Z-0-0-80.

Series SMA – receptacles

Straight bulkhead receptacles

Hermetically sealed, jacks (female)

- RoHs compliant alternative on request
- Front mounting



SMA

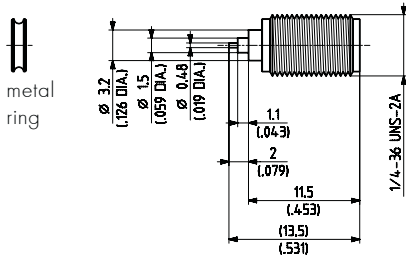

Fig. 1

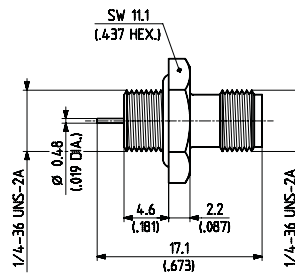

Fig. 2

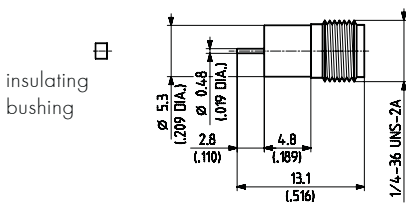

Fig. 3

HUBER+SUHNER type	Item no.	Packaging	Plating body	Mounting hole	Fig.	Notes
22_SMA-50-0-10/111_NE ¹⁾	22641291	single	gold	ML 42	1	"Spark plug" with metal ring seal leak rate 10 ⁻⁸ Torr l/sec
22_SMA-50-0-12/111_NE 22_SMA-50-0-12/111_NY	84042904 22641293	single tray 75 pcs.		ML 98	2	with panel seal tap drill 74_Z-0-0-24 leak rate 10 ⁻⁶ Torr l/sec
22_SMA-50-0-15/111_NE	22544588	single		ML 96	3	for direct soldering ¹⁾ soldering temperature 250 °C/482 °F leak rate 10 ⁻⁸ Torr l/sec

¹⁾ Use assembly tool 74_Z-0-0-75 and torque wrench 74_Z-0-0-80.

Series SMA - receptacles

Straight panel receptacles

With solder end, jacks (female)

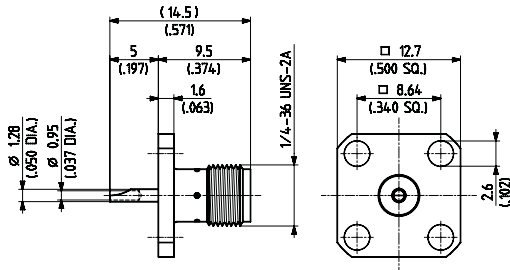

HUBER+SUHNER type	Item no.	Packaging	Plating body	Notes
23_SMA-50-0-1/111_NE	22640090	single	gold	flush dielectric
23_SMA-50-0-1/111_NH	22651409	bulk 100 pcs.		
23_SMA-50-0-51/199_NE	22543948	single	passivated stainless steel	

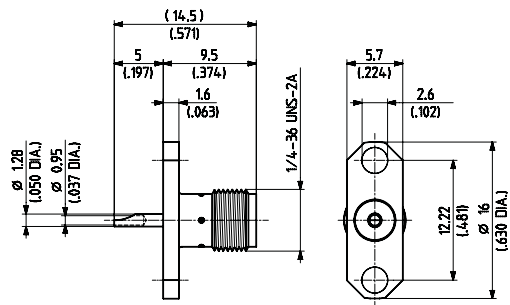

HUBER+SUHNER type	Item no.	Packaging	Plating body	Notes
23_SMA-50-0-11/111_NE	22640095	single	gold	flush dielectric
23_SMA-50-0-41/133_NE	22543984	single	SUCOPLATE®	flush dielectric
23_SMA-50-0-41/133_NH	22644383	bulk 100 pcs.		
23_SMA-50-0-61/199_NE	22544796	single	passivated stainless steel	flush dielectric

All highlighted types are HUBER+SUHNER ECO types.

With tab end, plug (male)

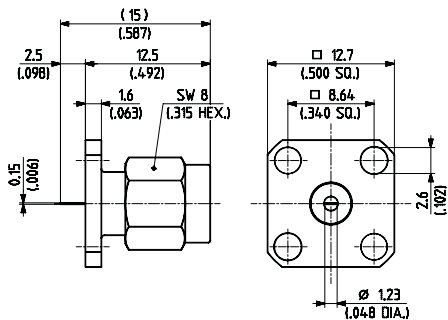

HUBER+SUHNER type	Item no.	Packaging	Plating body	Notes
13_SMA-50-0-2/111_NE	22640056	single	gold	flush dielectric

Series SMA - receptacles

Straight panel receptacles

With tab end, jacks (female)

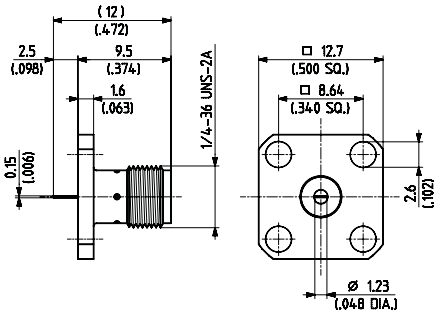

HUBER+SUHNER type	Item no.	Packaging	Plating body	Notes
23_SMA-50-0-2/111_NE	22640091	single	gold	flush dielectric
23_SMA-50-0-52/199_NE	22543487		passivated stainless steel	

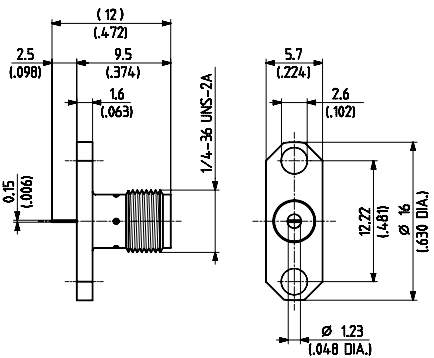

HUBER+SUHNER type	Item no.	Packaging	Plating body	Notes
23_SMA-50-0-12/111_NE	22640096	single	gold	flush dielectric
23_SMA-50-0-62/199_NE	22544779		passivated stainless steel	

Series SMA - receptacles

Straight panel receptacles

With coaxial end, jacks (female)

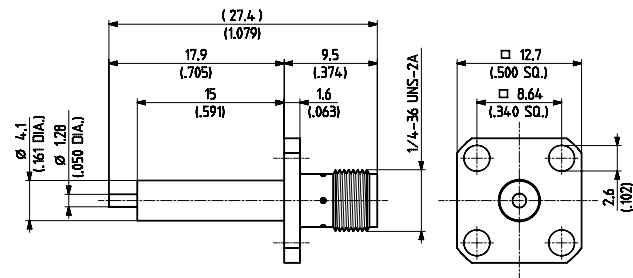

Fig. 1

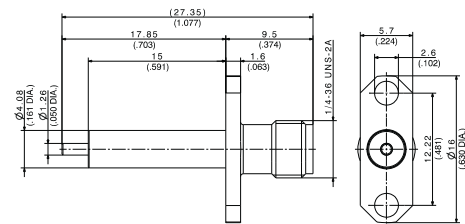

Fig. 2

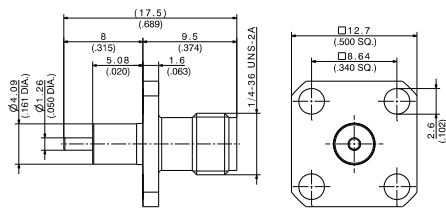

Fig. 3

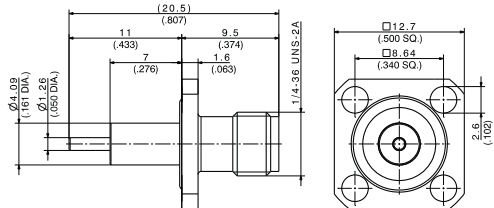

Fig. 4

HUBER+SUHNER type	Item no.	Packaging	Plating body	Notes	Fig.
23_SMA-50-0-3/111_NE	22640092	single	gold	extended dielectric	1
23_SMA-50-0-13/111_NE	22640097	single	gold	extended dielectric	2
23_SMA-50-0-13/111_NH	22658873	bulk 100 pcs.			
23_SMA-50-0-53/199_NE	22641394	single	passivated stainless steel	extended dielectric	1
23_SMA-50-0-53/199_NH	22649843				
23_SMA-50-0-272/133_NH	23030310	bulk 100 pcs	SUCOPLATE®	extended dielectric	3
23_SMA-50-0-324/111_NY	84035778	tray 100 pcs.	SUCOPRO® gold plating	extended dielectric with panel sealing	4

All highlighted types are HUBER+SUHNER ECO types.

Series SMA - receptacles

Straight panel receptacle

With coaxial end, jack (female)

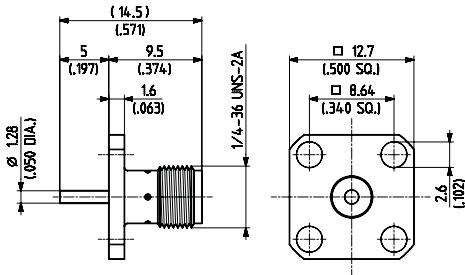

HUBER+SUHNER type	Item no.	Packaging	Plating body	Notes
23_SMA-50-0-21/111_NE	22640101	single	gold	flush dielectric

Right angle panel receptacle

With solder end, jack (female)

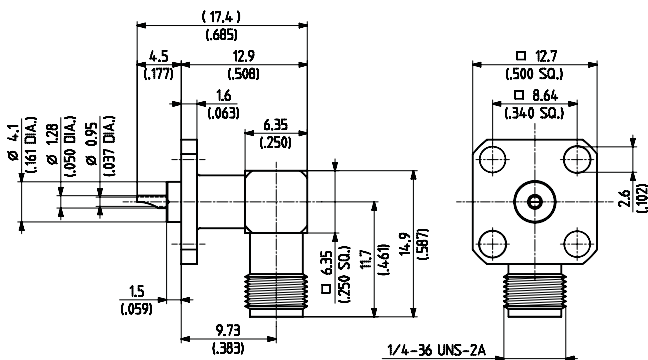
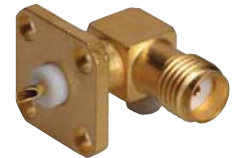

HUBER+SUHNER type	Item no.	Packaging	Plating body	Notes
28_SMA-50-0-1/111_NE	22641321	single	gold	extended dielectric

Series SMA – receptacles

26.5 GHz – straight panel receptacle

With tab end, jack (female)

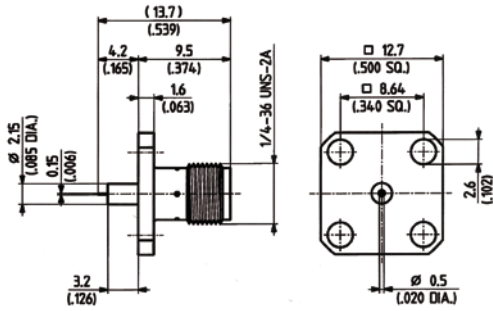

HUBER+SUHNER type	Item no.	Packaging	Plating body	Mounting hole	Notes
23_SMA-50-0-94/199_NE	22649049	single	passivated stainless steel	ML 93	extended dielectric

Series SMA - PCB connectors

Straight PCB jacks (female)

- Edge mount



SMA

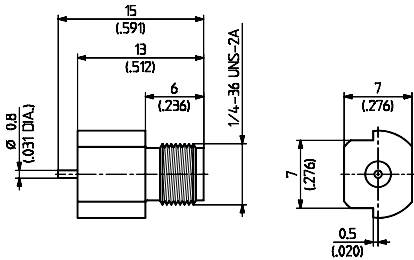

Fig. 1

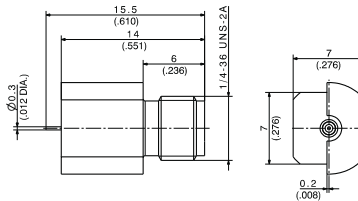

Fig. 2

HUBER+SUHNER type	Item no.	Packaging	Plating body	Mounting hole	Fig.
82_SMA-S50-0-45/111_NE	22652330	single	SUCOPRO® gold plating	ML 132	1
82_SMA-S50-0-45/111_NM	84037646	tape and reel 500 pcs.	SUCOPRO® gold plating	ML 132	1
92_SMA-50-0-10/111_NE	84120623	single	SUCOPRO® gold plating	ML 132	2
92_SMA-50-0-10/111_NM	84036781	tape and reel 500 pcs.	SUCOPRO® gold plating	ML 132	2

All highlighted types are HUBER+SUHNER ECO types.

Straight PCB jacks (female)

- Without stand-off

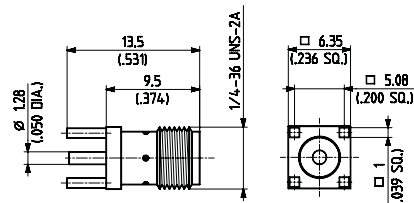

HUBER+SUHNER type	Item no.	Packaging	Plating body	Mounting hole
82_SMA-50-0-1/111_NE	22543359	single	gold	ML 41
82_SMA-50-0-1/111_NH	22644334	bulk 100 pcs.	gold	ML 41

Series SMA - PCB connectors

Right angle PCB jacks (female)

- Without stand-off

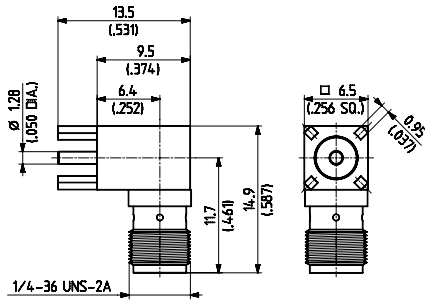

HUBER+SUHNER type	Item no.	Packaging	Plating body	Mounting hole
85_SMA-50-0-101/111_NE	22658792	single	gold	ML41
85_SMA-50-0-101/111_NH	22652140	bulk 100 pcs.		

- With stand-off

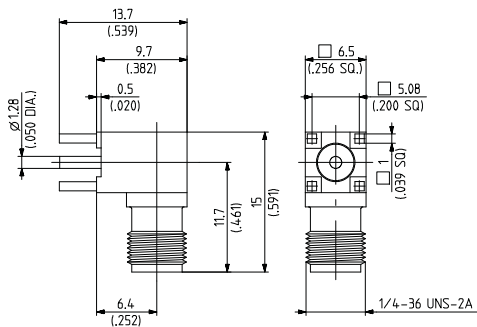

HUBER+SUHNER type	Item no.	Packaging	Plating body	Mounting hole
85_SMA-50-0-144/111_YH	23000527	bulk 100 pcs.	gold	ML41

Series SMA – protective caps and shorts

Caps for jacks

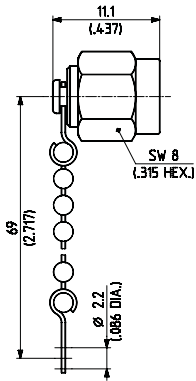

Fig. 1

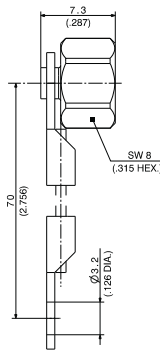

Fig. 2



HUBER+SUHNER type	Item no.	Packaging	Plating body	Notes	Fig.
62_SMA-0-0-1/-11_NE	22640159	single	gold	with chain	1
62_SMA-0-0-8/-3_NE	84120887	single	SUCOPLATE®	with wire, IP68	2

All highlighted types are HUBER+SUHNER ECO types.

Shorting cap

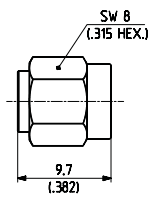

HUBER+SUHNER type	Item no.	Packaging	Plating body
64_SMA-50-0-1/111_NE	22640161	single	gold