

Studs · with internal hexagon, similar to DIN 6379, for nuts for T-Slots

23040.0726



Product Description

Studs combined with T-nuts DIN 508 (EH 23010./23020.), fixture nuts DIN 6330 (EH 23070.) and plain washers DIN 6340 (EH 23060.) become complete clamping studs. These studs are characterised by the rolled thread.

Material

- Heat-treated steel

Assembly

The stud has an internal hexagon additionally. This guarantees a fast and simple assembling and dismantling.

More information

References

For torques and strengths please refer to appendix - Technical Data -

Further products

- Nuts for T-Slots, DIN 508
- Studs, DIN 6379 for T-nuts
- Studs, DIN 6379 b1 long for nut for T-Slots
- Shaft / Plain Washers, DIN 6340 heat-treated
- Fixture Nuts, DIN 6330 (height 1,5 d)

Drawing

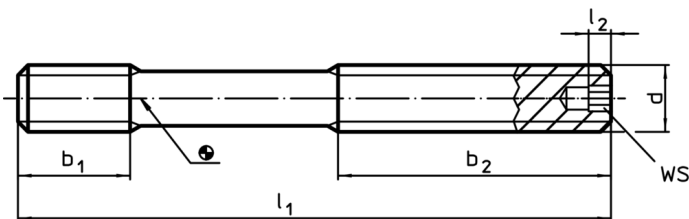

Order information

d	l ₁	Dimensions			WS	[g]	Art. No.
		b ₁	b ₂	l ₂			
quality 10.9							
[mm]	[mm]	[mm]	[mm]	[mm]	[mm]	[g]	
M12	160	15	100	4	4	115	23040.0726

Application example



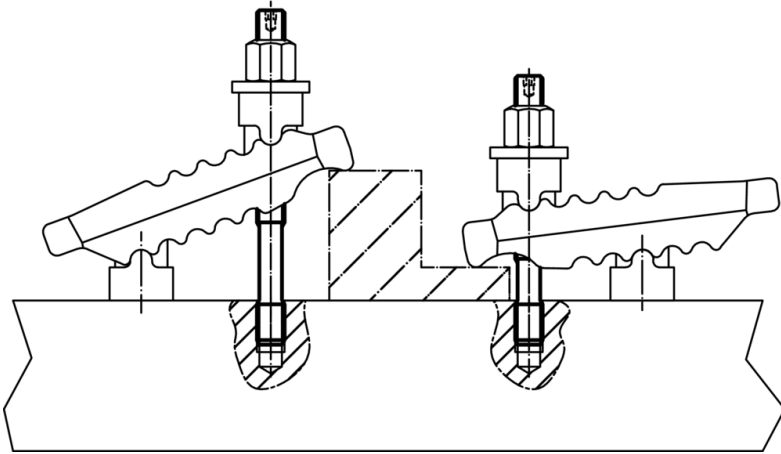

Compliance

RoHS compliant

Compliant according to Directive 2011/65/EU and Directive 2015/863

Does not contain SVHC substances

No SVHC substances with more than 0.1% w/w contained - SVHC list [REACH] as of 10.06.2022

Does not contain Proposition 65 substances

No Proposition 65 substances included
<https://www.P65Warnings.ca.gov/>

Free from Conflict Minerals

This product does not contain any substances designated as "conflict minerals" such as tantalum, tin, gold or tungsten from the Democratic Republic of Congo or adjacent countries.