

C.A 6240







Microhm meter

Thank you for purchasing a **C.A. 6240 microhmmeter**.

To obtain the best service from your instrument:

- **read** this user manual carefully,
- **comply with** the precautions for use.

	WARNING, risk of DANGER! The operator must refer to this user's manual whenever this danger symbol appears.
	Equipment protected by double insulation.
	Earth.
	The CE marking indicates conformity with European directives, in particular LVD and EMC.
	The rubbish bin with a line through it indicates that, in the European Union, the product must undergo selective disposal in compliance with Directive WEEE 2002/96/EC. This equipment must not be treated as household waste.

Definition of measurement categories:

- Measurement category IV corresponds to measurements taken at the source of low-voltage installations.
Example: power feeders, counters and protection devices.
- Measurement category III corresponds to measurements on building installations.
Example: distribution panel, circuit-breakers, machines or fixed industrial devices.
- Measurement category II corresponds to measurements taken on circuits directly connected to low-voltage installations.
Example: power supply to electro-domestic devices and portable tools.

PRECAUTIONS FOR USE

This device is compliant with safety standard IEC 61010-2-030 and the leads are compliant with IEC 61010-031, for voltages up to 50 V with respect to earth in category III.

Failure to observe the safety instructions may result in electric shock, fire, explosion, and destruction of the instrument and of the installations.

- The operator and/or the responsible authority must carefully read and clearly understand the various precautions to be taken in use. Sound knowledge and a keen awareness of electrical hazards are essential when using this instrument.
- If you use this instrument other than as specified, the protection it provides may be compromised, thereby endangering you.

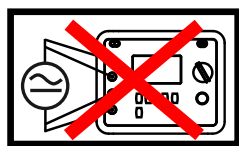

- Do not use the instrument on conductors likely to be connected to line power or on earth conductors that are not disconnected.

- Do not use the instrument if it seems to be damaged, incomplete, or poorly closed.
- Before each use, check the condition of the insulation on the leads, housing, and accessories. Any item of which the insulation is deteriorated (even partially) must be set aside for repair or scrapping.

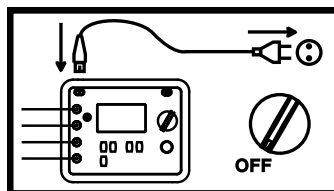

- Check that the switch is set to OFF before plugging in the mains cord to recharge the battery of the instrument.

- Respect the value and type of the fuse to avoid damaging the instrument and cancelling the warranty.
- Set the switch to OFF when the instrument is not in use.

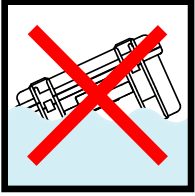

- Do not immerse the C.A 6240 microohmmeter in water.

- Use connection accessories which have an overvoltage category and service voltage greater than or equal to those of the measuring instrument (50 V Cat III). Use only accessories that comply with safety standards (IEC 61010-2-031).

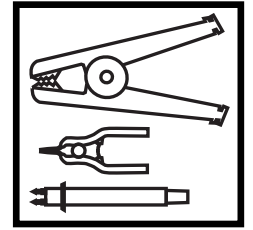

- All troubleshooting and metrological checks must be performed by competent and accredited personnel.

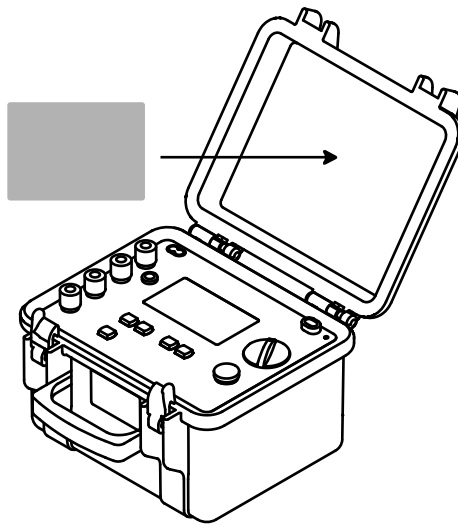

Attach one of the 5 specifications labels, with your appropriate language, on the inside of the lid.

CONTENTS

1. PRESENTATION	5
1.1. Functions of the instrument	6
1.2. Delivery condition	6
1.3. Accessories	6
1.4. Spares	6
2. BATTERY CHARGE	7
3. RESISTANCE MEASUREMENT	8
3.1. Measurement of a very low value	9
3.2. Repetitive measurements	10
3.3. Error messages	10
4. STORAGE OF RESULTS	12
4.1. Storing	12
4.2. Read memory	13
4.3. Erase memory	13
4.4. Further information	13
4.5. Automatic recording	13
4.6. Transfer of data to PC	14
5. OTHER FUNCTIONS (SET-UP)	15
5.1. Complete erasure of memory	15
5.2. Programming the time	15
5.3. Programming the date	15
5.4. Programming of automatic stopping time	16
5.5. Displaying the internal parameters of the instrument	16
6. CHARACTERISTICS	17
6.1. Reference conditions	17
6.2. Characteristics of the resistance measurements	17
6.3. Characteristics of the voltage measurements on the terminals of the resistance measured	17
6.4. Characteristics of the measurements of the current flowing in the resistance measured	17
6.5. Influences on the resistance measurement	18
6.6. Power supply	18
6.7. Environmental conditions	18
6.8. Characteristics of construction	19
6.9. Conformity to international standards	19
6.10. Electromagnetic compatibility	19
7. MAINTENANCE	20
7.1. Recharging the battery	20
7.2. Replacement of the fuse	20
7.3. Cleaning	20
7.4. Upgrading the software of the instrument	20
8. WARRANTY	21

1. PRESENTATION

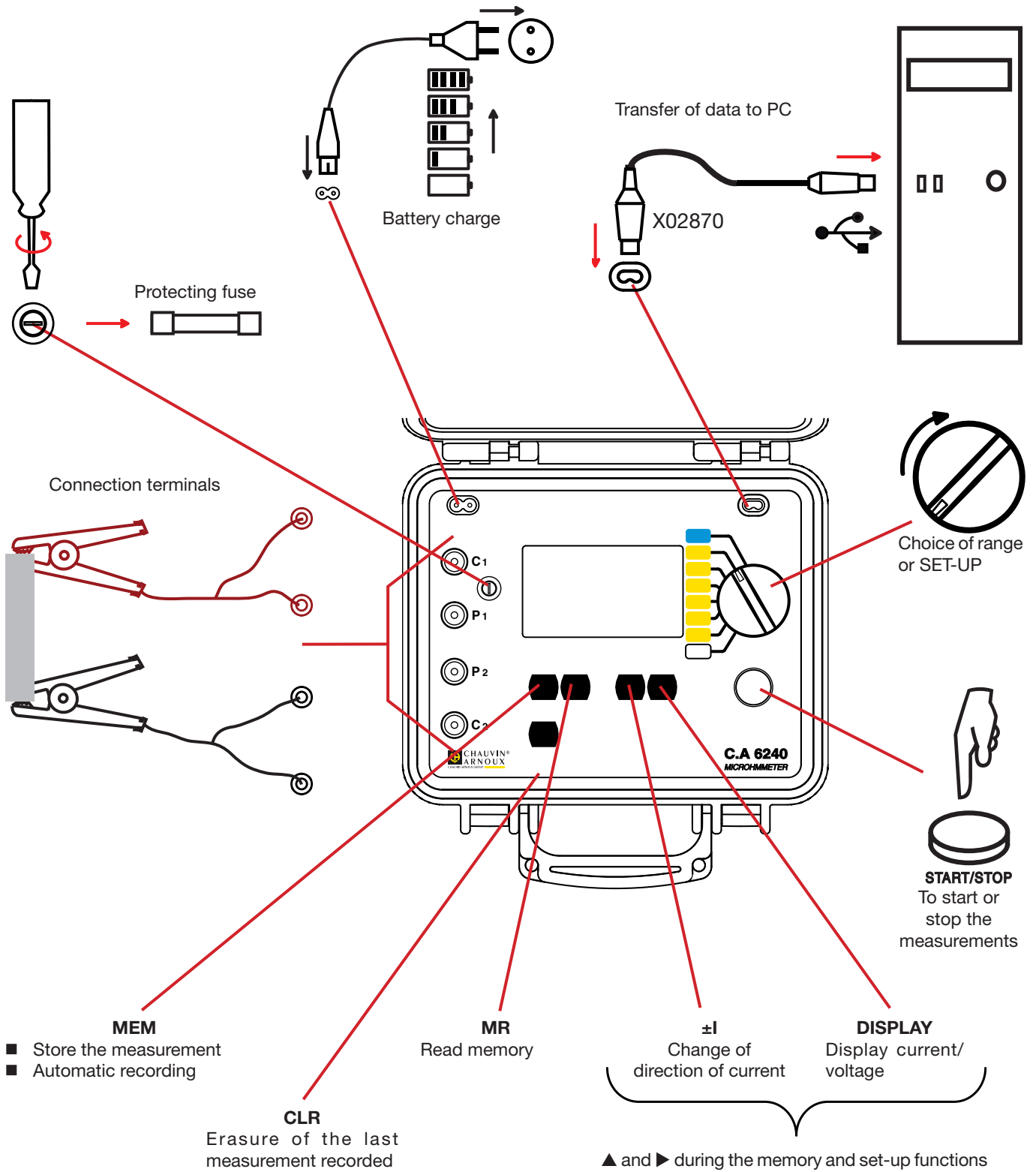

1.1. FUNCTIONS OF THE INSTRUMENT

The C.A 6240 microhmmeter is a portable measuring instrument intended for the measurement of very low resistance values. It is enclosed in a site case and powered by a rechargeable battery with a built-in charger.

- Measurement functions : resistance
Controls : 8-position switch, 5-key keypad, and 1 START/STOP button
Display : LCD display unit, 100 x 57 mm, back-lit, having 2 simultaneous digital display levels

Representation of the display unit

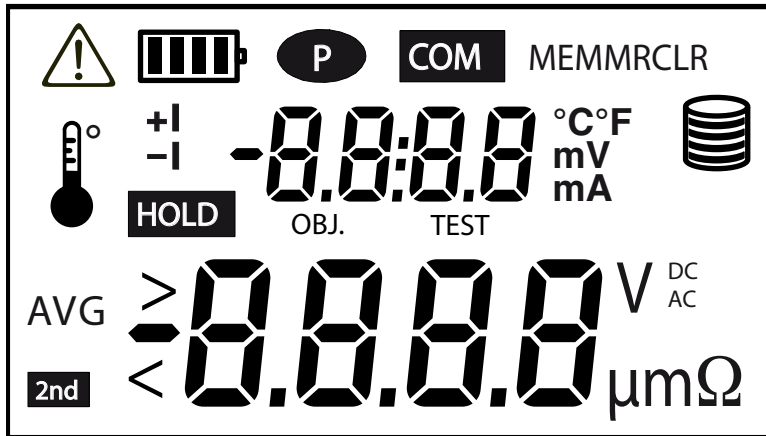

indicates flashing

1.2. DELIVERY CONDITION

The C.A 6240 is delivered in a cardboard box with a carrying bag of accessories containing:

- one set of two 10 A Kelvin clips with a 3 m cable,
- one 2 m power cord,
- one optical / USB communication cable,
- "Micro Ohmmeter Transfer" software,
- simplified operating manuals (1 per language),
- one user manuals on CD-ROM (1 file per language).

1.3. ACCESSORIES

GB power cord 2 m long
Set of 2 double probe tips
Set of 2 miniature Kelvin clips
C A 846 thermo-hygrometer
Optical / RS communication cable

1.4. SPARES

Set of 10 FF 12 fuses, 5 A – 500 V - 6.3 x 32 mm
Set of two 10 A Kelvin clips with 3 m cable
2P EURO power cord 2 m long
Standard carrying bag
Optical / USB communication cable

For accessories and spare parts, visit our website:

www.chauvin-arnoux.com

2. BATTERY CHARGE

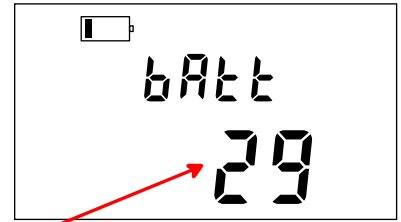
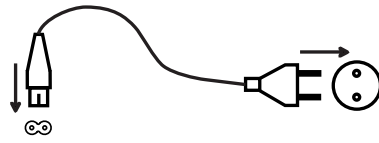
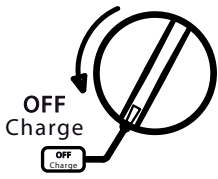

Current battery capacity in %.

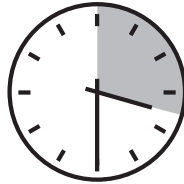
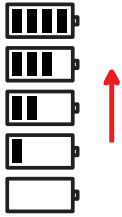

Charging time: 3 h 30



Start by fully charging the battery before the first use.

In the 10 A range, the battery life is approximately 1h20. It is therefore best to charge the battery before starting series of measurements. Charging must be done between 0 and 40°C.

The battery life of the instrument depends on the range. To display it (before making the measurement):

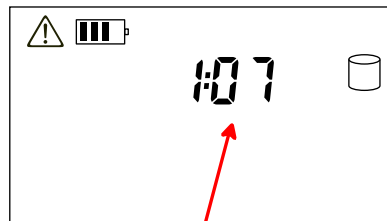
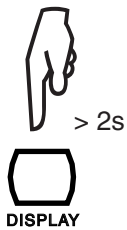

Remaining battery life

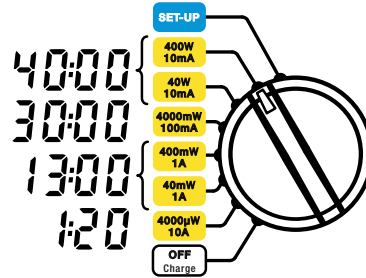

Average battery life according to range

Following long-term storage, the battery may be completely discharged. In this case, the first charge may last several hours. The capacity of the battery and therefore the battery life of the instrument will be temporarily reduced. The battery will recover its initial capacity after 5 recharging cycles.

3. RESISTANCE MEASUREMENT

1) Connect the 2 cables to the 4 measurement terminals, then the 2 Kelvin clips to the object to be tested, which must not be live.

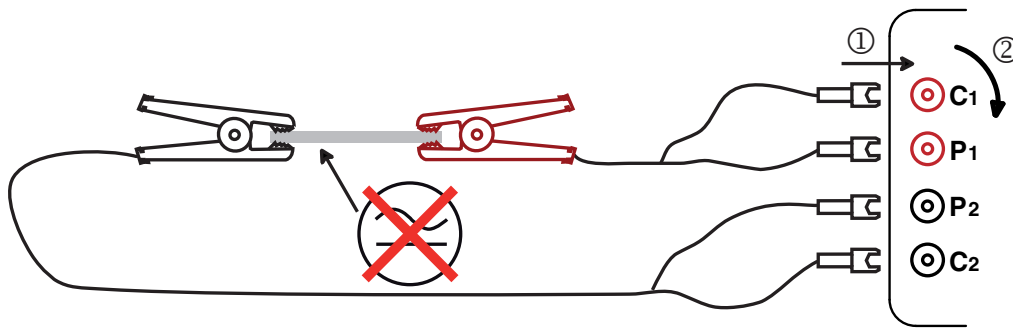

2) Set the switch to 400Ω - 10 mA.

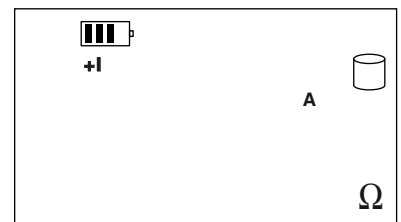
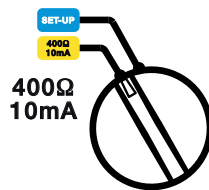

3) Start the measurement by pressing the START/STOP button.

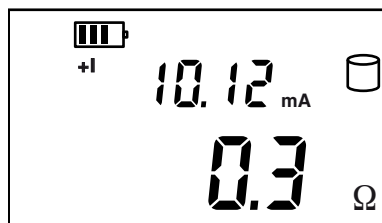

If the measurement is too low, turn the switch to the next lower range and restart the measurement. Continue until the display shows at least 3 digits.

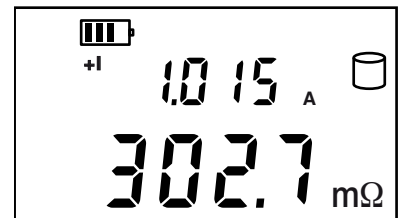
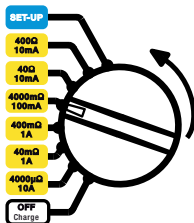

4) Press the START/STOP button again to stop the measurement...

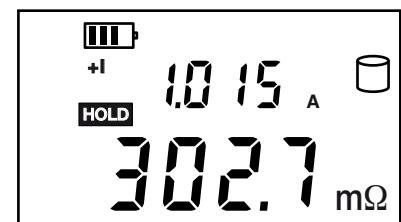

...or disconnect one of the 2 clips.

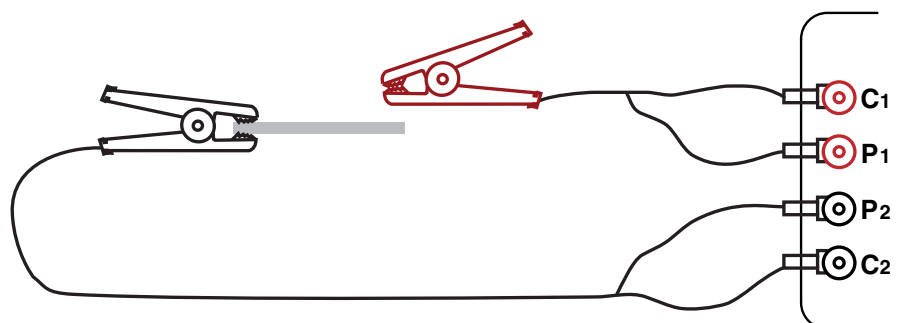

The energy accumulated in an **inductive** component when a measurement is made on it must be released.

⚠ You must never in any circumstances touch or disconnect the measurement leads until you have stopped making the measurement and waited at least ten seconds for all of the energy in the item tested to be dissipated. Failure to observe this precaution may result in the production of an arc, potentially hazardous for both the instrument and the operator.

In both cases, the last measurement made is displayed, along with the **HOLD** symbol.

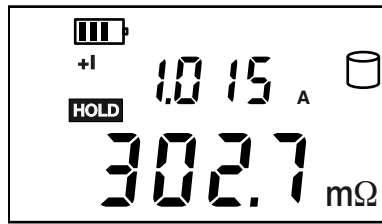

If the measurement is stopped by the disconnection of a clip, simply connecting it to another object starts another measurement, with no need to press the START/STOP key.

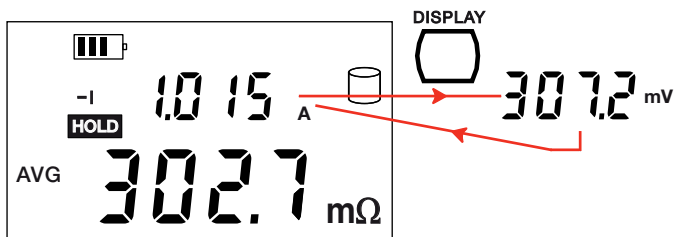

To display the voltage on the terminals of the resistance instead of the measurement current, press the DISPLAY key.

3.1. MEASUREMENT OF A VERY LOW VALUE

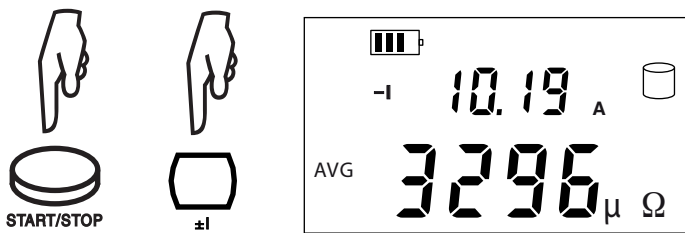

Reverse the direction of the current by pressing the ±I key and the instrument displays the average:

$$\frac{R(+I) + R(-I)}{2}$$

This serves to eliminate any thermoelectric effect.

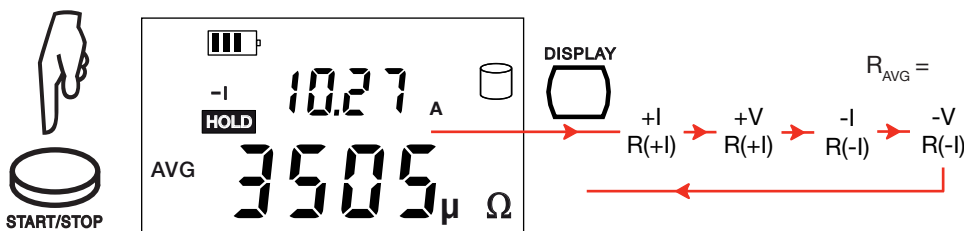

To display the values R(+I) and R(-I), press the DISPLAY key.

3.2. REPETITIVE MEASUREMENTS

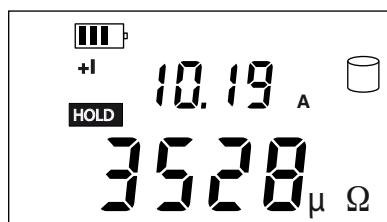
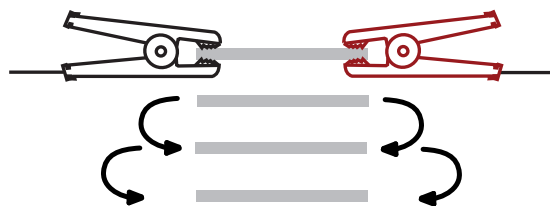
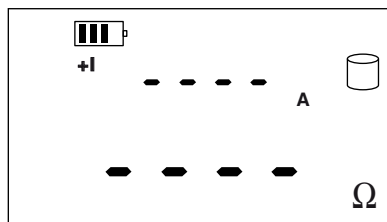
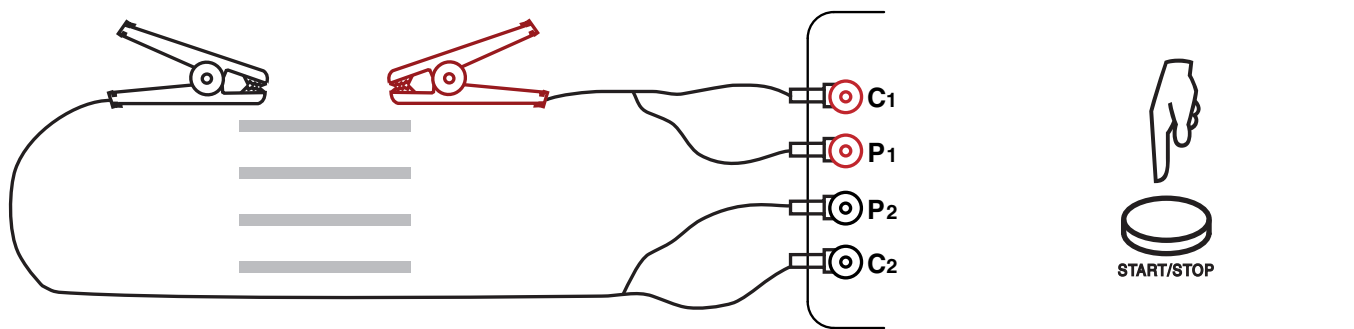

Connect the clips to the first object to be measured. The measurement starts automatically. Withdraw the clips: the measurement stops and the result is displayed. Connect the clips to the second object to be measured. The measurement restarts automatically. And so on. After the last measurement, press the START/STOP button again.

3.3. ERROR MESSAGES

3.3.1. PRESENCE OF A VOLTAGE

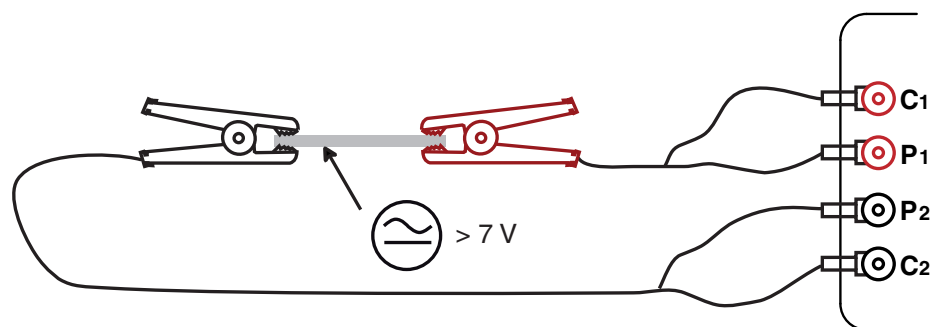

If there is an external voltage on the device to be measured...

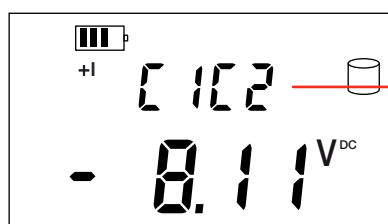

...pressing the START/STOP button has no effect: the measurement is impossible.

Remove the voltage to make the measurement.

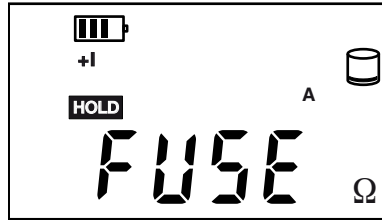
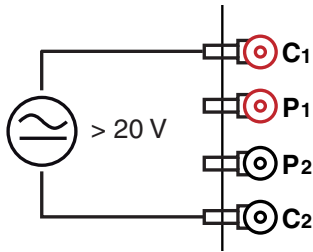

If a voltage greater than 20 V is applied between terminals C1 and C2, the fuse on the front panel of the instrument will blow and must be replaced (see §7.2).

3.3.2. RANGE OVERTHOOT

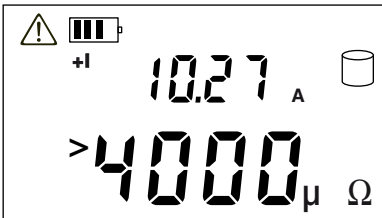

If the instrument indicates a range overshoot (> symbol), turn the switch to the next higher range and restart the measurement. Continue for as long as the range overshoot message is displayed.

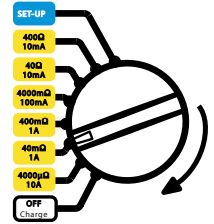

3.3.3. NOISY MEASUREMENT

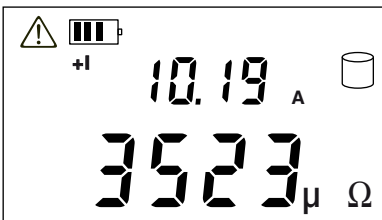

The  symbol indicates that the measurement is noisy and that its accuracy is not guaranteed.

3.3.4 OVERHEATING

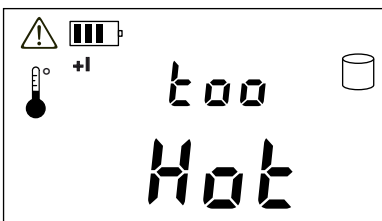

If a measurement in the 10 A range lasts several minutes, it causes internal overheating, making all measurements impossible. It is then necessary to wait for the instrument to cool before resuming the measurements.

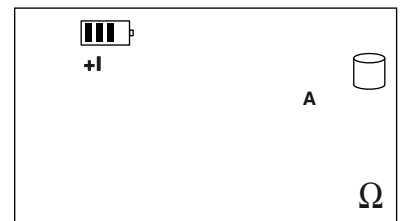

4. STORAGE OF RESULTS

Data storage is organised into objects (OBJ.), each of which can contain several tests (TEST). OBJ. corresponds to the object tested and each test corresponds to a measurement made on the object. The instrument can store 100 measurements.

4.1 STORING

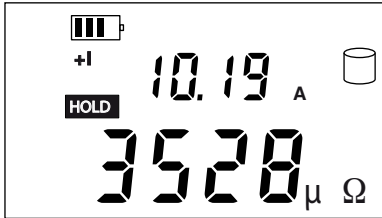

Once the measurement is over, it can be recorded. Press the MEM key.



The instrument proposes the first free location in memory. If it is acceptable, execute a long press on the MEM key.

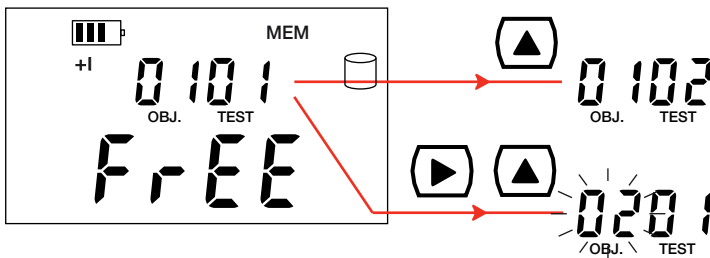
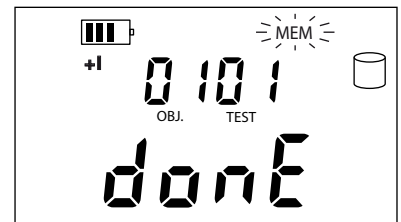
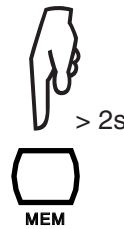

To change the number of the test or of the object, use the arrows.

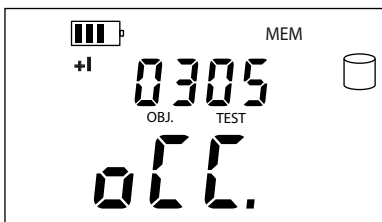

If the location chosen is already occupied, the instrument so indicates. But it is possible to overwrite the old measurement with the new one.

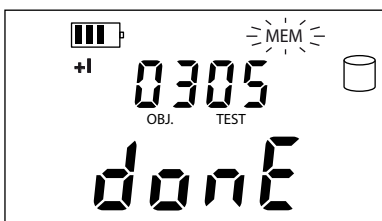
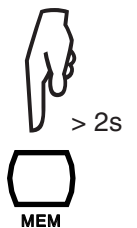

or



To exit from the function without recording anything, press the MEM key.

4.2. READ MEMORY

It is necessary first of all to stop the measurement by pressing the START/STOP button.

To change objects.

To read all tests containing a record.

To exit from the read memory function.

4.3. ERASE MEMORY

To erase a record (read memory or not):

Use the arrows to select the test to be erased.
The complete erasure of the memory is described in section 5.1.

4.4. FURTHER INFORMATION

Memory empty

Memory full

4.5. AUTOMATIC RECORDING

To choose the start location for recording.

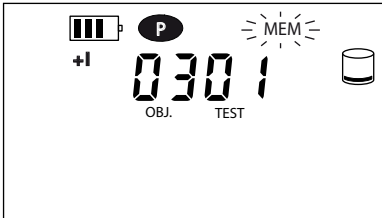

Automatic recording activated.

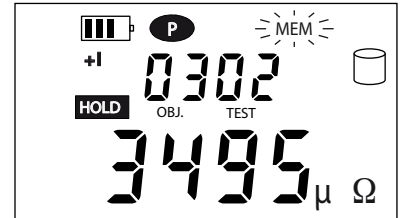

At each new measurement, the test number is incremented and the measurement is recorded.

To stop automatic recording, press the START/STOP button.

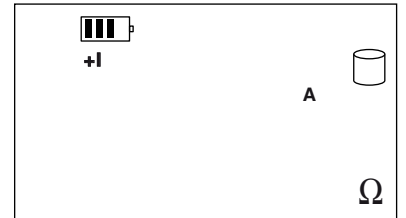

4.6. TRANSFER OF DATA TO PC

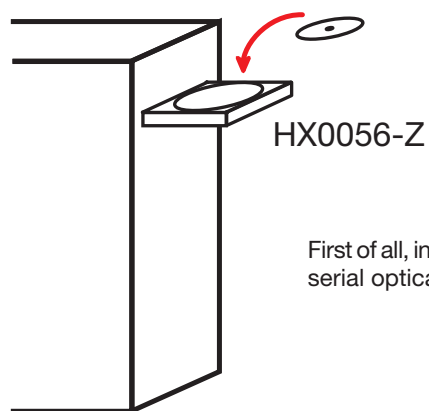
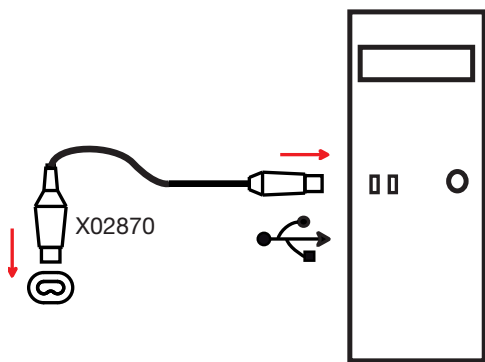

First of all, install the driver of the USB/serial optical adapter (HX0056-Z).

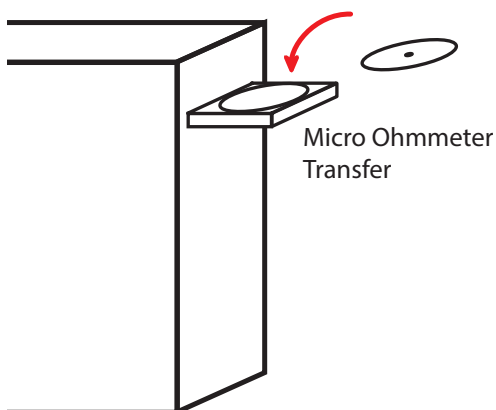

Then install the "Micro Ohmmeter Transfer" application software as explained in readme.txt.

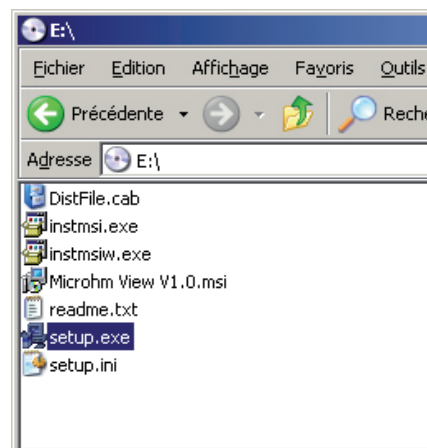

To use "Micro Ohmmeter Transfer", refer to the help function.

5. OTHER FUNCTIONS (SET-UP)

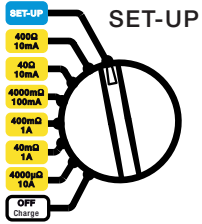

5.1. COMPLETE ERASURE OF MEMORY

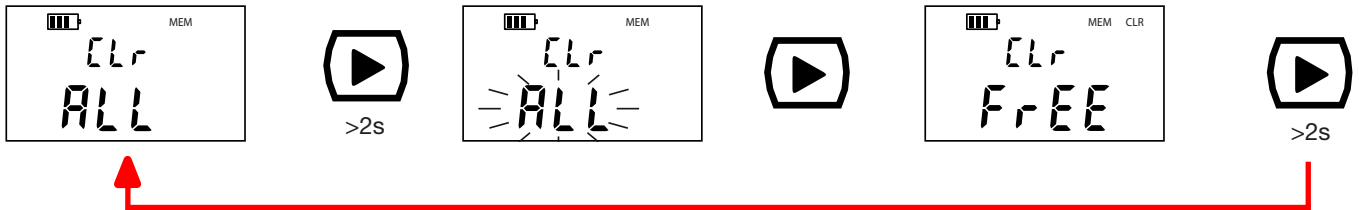

5.2. PROGRAMMING THE TIME

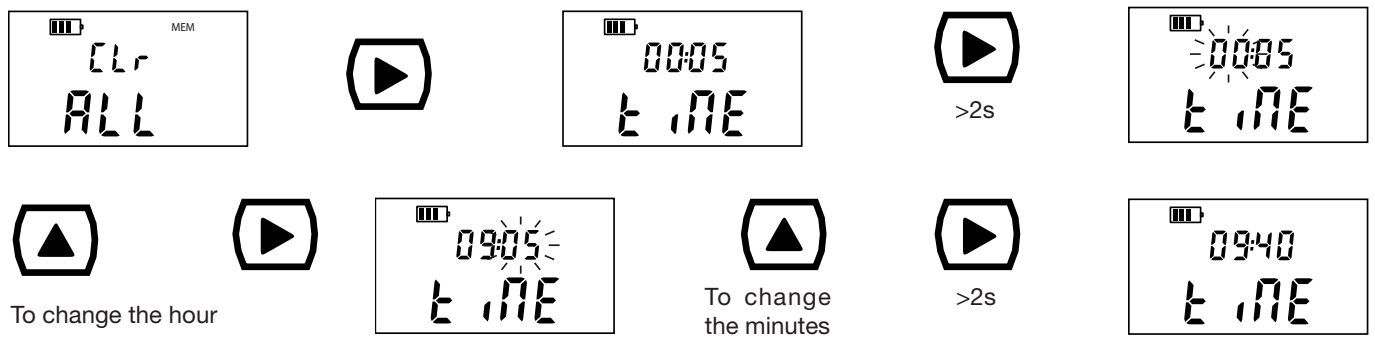

5.3. PROGRAMMING THE DATE

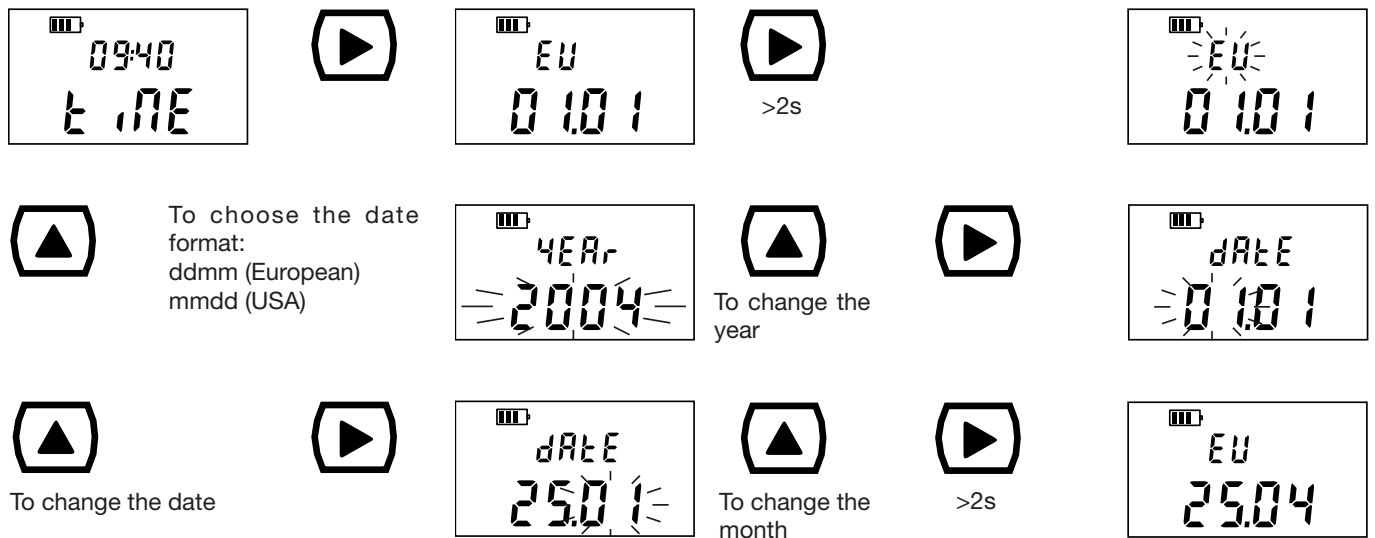

5.4. PROGRAMMING OF AUTOMATIC STOPPING TIME

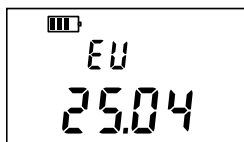

>2s



To choose automatic power-down select "ON", if not, choose "OFF".



To adjust the On time: 5, 10, or 15 minutes.



>2s



5.5. DISPLAYING THE INTERNAL PARAMETERS OF THE INSTRUMENT

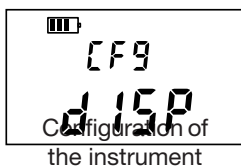
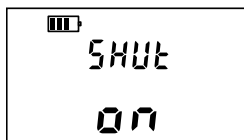

Configuration of the instrument



>2s

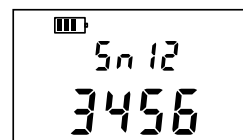

Serial number



Software version

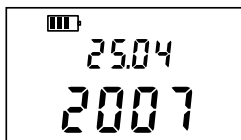

Date of last calibration

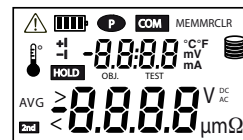

Lighting of all segments of the display unit



>2s

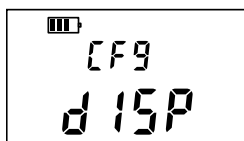

6. CHARACTERISTICS

6.1. REFERENCE CONDITIONS

Quantities of influence	Reference values
Temperature	23 ± 3 °C
Relative humidity	45 to 55 % RH
Supply voltage	6 V ± 0,2 V
External voltage present on the terminals of the resistance being tested	zero
Inductance of the resistance being tested	zero
Electric field	zero
Magnetic field	< 40 A/m

6.2. CHARACTERISTICS OF THE RESISTANCE MEASUREMENTS

There must be no voltage on the element to be measured.

Measurement range	5 - 3999 μΩ	4,00 - 39,99 mΩ	40,0 - 399,9 mΩ	400 - 3999 mΩ	4,00 - 39,99 Ω	40,0 - 399,9 Ω
Resolution	1 μΩ	10 μΩ	100 μΩ	1 mΩ	10 mΩ	100 mΩ
Accuracy	± 0,25% ± 2 pt					
Measurement current	10,2 A ± 2% (1)	1,02 A ± 2%		102 mA ± 2%	10,2 mA ± 2% (2)	
No-load voltage	4 to 6 V					

(1) With a nominal value of 10.2 A, the measurement current is at least 10 A whatever the charge condition of the battery.

(2) The current is 10 mA only up to 300 Ω. If the battery is low, it can fall to as low as 8 mA.

6.3. CHARACTERISTICS OF THE VOLTAGE MEASUREMENTS ON THE TERMINALS OF THE RESISTANCE MEASURED

Measurement range	0,010 - 3,999 mV	4,00 - 39,99 mV	40,0 - 399,9 mV	0,400 - 3,999 V	4,00 - 4,70 V
Resolution	1 μV	10 μV	100 μV	1 mV	10 mV
Accuracy	± 0,5% ± 10 pt	± 0,5% ± 1 pt			

6.4. CHARACTERISTICS OF THE MEASUREMENTS OF THE CURRENT FLOWING IN THE RESISTANCE MEASURED

Measurement range	5,00 - 39,99 mA	40,0 - 399,9 mA	0,400 - 3,999 A	4,00 - 11,00 A
Resolution	10 μA	100 μA	1 mA	10 mA
Accuracy	± 0,5% ± 2 pt	± 0,5% ± 1 pt		

6.5. INFLUENCES ON THE RESISTANCE MEASUREMENT

Quantities of influence	Range of use	Variation of the measurement	
		Typical	Maximum
Temperature	-10 to + 55 °C	0,1 %/10 °C	0,5 %/10 °C + 2pt
Relative humidity	10 to 85 % RH @ 45°C	0,1 %	0,5 % + 2pt
Supply voltage	5 to 7 V	2 pt	0,2%/ V + 2pt
Series mode rejection, 50/60 Hz (1)	$U (AC) = (R_{\text{measured}} \times I_{\text{measurement}})$	< 0,2%	2% + 1pt
Common mode rejection, 50/60 Hz AC	0 to 50 V AC	> 80 dB	> 60 dB

(1) Example: If the measured resistance is 1 mΩ and the measurement current is 10 A, an alternating voltage of 1 mV RMS in series with the resistance to be measured will induce an error of not more than 2%.

6.6. POWER SUPPLY

The instrument is powered by a rechargeable 6 V 8.5Ah NiMH battery pack. This has many advantages :

- long life with small size and weight,
- the possibility of recharging your battery rapidly,
- a very small memory effect: you can recharge your battery rapidly, even if it is not fully discharged, without reducing its capacity,
- protection of the environment: no polluting materials such as lead or cadmium.

The NiMH technology allows a limited number of charging/discharging cycles. The number depends on the conditions of use and on the charging conditions. Under optimum conditions, the number of cycles is 200.

The instrument has 2 charging modes:

- rapid charging: the battery recovers 90% of its capacity in 3h;
- maintenance charging: this mode cuts in when the battery is very low and at the end of rapid charging.

The battery life depends on the ranges used

	Number of measurements (1)
10 A range	850
1 A range	3 500
100 mA range	4 500
10 mA range	5 000
Instrument on standby or off	battery life 4 to 6 months

(1) established for measurements lasting 5s, every 25s.

6.7. ENVIRONMENTAL CONDITIONS

Use indoors or outdoors.

Range of use	- 10 to +55 °C	10 to 85 % RH
Storage (without battery)	- 40 to +70 °C	10 to 90 % RH
Altitude	< 2000 m	
Degree of pollution	2	

For long-term storage (2 years) with the battery, conditions must not depart from the range -20 to +30°C and 85% RH; otherwise, the battery life will be degraded. For short-term storage (1 month), the temperature can reach 50°C.

6.8. CHARACTERISTICS OF CONSTRUCTION

Overall dimensions of the instruments (L x W x H): 273 x 247 x 176 mm

Mass: approximately 4.5 kg

IP 53 per NF EN 60529

IK 04 per NF EN 50102

6.9. CONFORMITY TO INTERNATIONAL STANDARDS

Electrical safety as per EN 61010-1

Measurement according to EN 61557 parts 1 and 4.

Safety level categories: measurement category III, 50V with respect to earth, 500V differential between terminals, and 300V cat II on the charger input

6.10. ELECTROMAGNETIC COMPATIBILITY

Emissions in a residential environment and immunity in an industrial setting compliant with EN 61326-1.

7. MAINTENANCE

 Except for the fuse, the instrument contains no parts that can be replaced by personnel who have not been specially trained and accredited. Any unauthorized repair or replacement of a part by an “equivalent” may gravely impair safety.

7.1. RECHARGING THE BATTERY



 The battery must be replaced by Manumasure or by a repairer approved by Chauvin Arnoux. Only fit the battery recommended by the manufacturer. Replacing the battery does not cause a loss of the data in memory. However, the date and time must be reprogrammed (see § 5.2 and 5.3).

7.2. REPLACEMENT OF THE FUSE

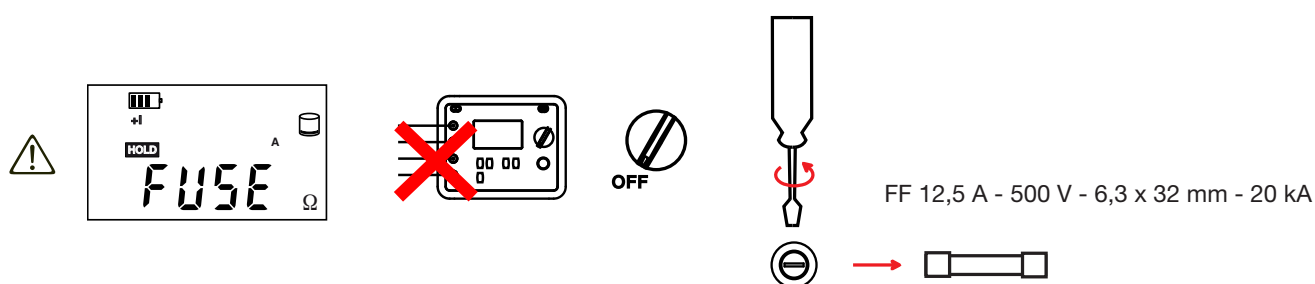

7.3. CLEANING

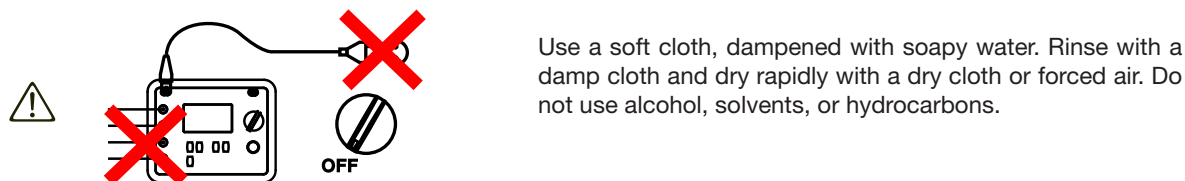

7.4. UPGRADING THE SOFTWARE OF THE INSTRUMENT

With a view to providing, at all times, the best possible service in terms of performance and technical upgrades, Chauvin Arnoux invites you to update the embedded software of the device by downloading the new version, available free of charge on our web site.

See you on our site:

www.chauvin-arnoux.com

Then go to “Support”, then “Download our software”, then “C.A 6240”.

Connect the device to your PC using the USB cord provided.

8. WARRANTY

Except as otherwise stated, our warranty is valid for **twelve months** starting from the date on which the equipment was sold. Extract from our General Conditions of Sale provided on request.

The warranty does not apply in the following cases:

- Inappropriate use of the equipment or use with incompatible equipment;
- Modifications made to the equipment without the explicit permission of the manufacturer's technical staff;
- Work done on the device by a person not approved by the manufacturer;
- Adaptation to a particular application not anticipated in the definition of the equipment or not indicated in the user's manual;
- Damage caused by shocks, falls, or floods.

FRANCE

Chauvin Arnoux Group

190, rue Championnet

75876 PARIS Cedex 18

Tél : +33 1 44 85 44 85

Fax : +33 1 46 27 73 89

info@chauvin-arnoux.com

www.chauvin-arnoux.com

INTERNATIONAL

Chauvin Arnoux Group

Tél : +33 1 44 85 44 38

Fax : +33 1 46 27 95 69

Our international contacts

www.chauvin-arnoux.com/contacts

